

**Relicensing Study 3.1.2**

**Northfield Mountain / Turners Falls  
Operations Impact on Existing Erosion and  
Potential Bank Instability  
Study Report**

**Volume III – Appendices**

**Northfield Mountain Pumped Storage Project (No. 2485) and  
Turners Falls Hydroelectric Project (No. 1889)**

*Prepared for:*



*Prepared by:*



**Kit Choi, PhD, PE**

**APRIL 2017**

## PREFACE

On October 14, 2016, FirstLight Hydro Generating Company (FirstLight) filed the final report (Volumes I-III) for Study No. 3.1.2 *Northfield Mountain / Turners Falls Operations Impacts on Existing Erosion and Potential Bank Instability* (Study No. 3.1.2) with the Federal Energy Regulatory Commission (FERC). On December 15, 2016, various stakeholders filed comments on the report, which FirstLight responded to on January 17, 2017. As noted in FirstLight's responsiveness summary, and in response to comments received, FirstLight agreed to re-issue the final report for Study No. 3.1.2 by April 3, 2017.

The contents of this volume remain largely unchanged from the version filed in October 2016, with the following exceptions:

- **Appendix E – Cross-section Survey Plots:** the contents of the appendix filed in October 2016 have been replaced with an updated set of cross-section survey plots which correctly show the orientation of each cross-section (i.e., right and left bank)
- **Appendix L – BSTEM Input Data:** As discussed in Volumes I and II, initial BSTEM modeling conducted at detailed study sites BC1-R and 2L used the incorrect riverbank geometry (i.e., left bank instead of right bank or vice-versa). BSTEM has since been re-run at these sites using the correct geometry. As such, the BSTEM input data used at these sites has been updated in Appendix L to reflect the conditions using the correct riverbank geometry.

It should also be noted that the quality of images used in a number of appendices was improved in response to stakeholder comments received. In the event that this occurred, the content of that appendix did not change, just the quality of the image.

## **LIST OF APPENDICES**

**APPENDIX A – BIOS FOR KEY TEAM MEMBERS**

**APPENDIX B – HISTORIC AERIAL PHOTOS OF THE 20 SITES IDENTIFIED IN THE ECP**

**APPENDIX C – UPLAND EROSION FEATURES**

**APPENDIX D – DETAILED STUDY SITE ASSESSMENTS**

**APPENDIX E – CROSS-SECTION SURVEY PLOTS**

**APPENDIX F – BSTEM TECHNICAL BACKGROUND**

**APPENDIX G – BSTEM BOAT WAVE ALGORITHM TECHNICAL BACKGROUND**

**APPENDIX H – SUPPLEMENTAL BOAT WAVE DATA (1997 & 2008)**

**APPENDIX I – SUPPLEMENTAL GROUNDWATER DATA (1997-1998)**

**APPENDIX J – ICE DATA AND SUPPLEMENTAL INFORMATION**

**APPENDIX K – ANNUAL HYDROGRAPHS AT MONTAGUE, MA (2000-2014)**

**APPENDIX L – BSTEM INPUT DATA**

**APPENDIX M – 2013 FRR RIVERBANK SEGMENTS WITH CAUSES OF EROSION**

# **APPENDIX A – BIOS FOR KEY TEAM MEMBERS**

## **ROBERT SIMONS, PhD, PE**

Dr. R.K. Simons principal fields of interest and expertise are hydrology, hydraulics, river mechanics, erosion and sedimentation, sediment transport, geomorphology, hydraulic structures, mathematical modeling, riverine habitat modeling, riparian vegetation modeling, wetlands analysis, and analysis related to various aspects of fisheries. Dr. Simons has extensive experience on hundreds of projects covering various aspects of civil engineering focusing on the interaction and effect of projects on watersheds, rivers, and estuaries related to changing hydrology, hydraulics, fluvial geomorphology, sediment transport, erosion and sedimentation, flooding, and channel stabilization. He has analyzed the effect of hydropower operation on flooding, geomorphic response, riverbank erosion, sediment exclusion and ejection from intake head works as well as effects on riparian vegetation and habitat for various species both aquatic and terrestrial. Dr. Simons developed design methodologies for river bank protection based on hydraulic principles, risk analysis, and probability of motion. He has developed and applied a number of computer models predicting sediment transport, erosion, sedimentation, riparian vegetation dynamics, and flow/habitat relationships. He has conducted channel restoration, channel maintenance, and habitat improvement analyses.

## **ANDREW SIMON, PhD, PE**

Dr. Andrew Simon is an internationally recognized geomorphologist at Cardno in Oxford, Mississippi. He has 35 years of research experience, 16 years with the US Geological Survey and 16 years at the USDA-Agricultural Research Service, National Sedimentation Laboratory. His process-based research has been in channel response of unstable channels, cohesive-soil erosion, streambank processes and modelling, and quantifying the role of vegetation on fluvial processes. This approach has championed the use of robust field instruments to collect data on the resistance of the channel boundary, a critical metric for analysis of channel erosion but one that is rarely used by others. He is the author of more than 100 technical publications, has edited several books and journals and is the senior developer of the Bank-Stability and Toe-Erosion Model (BSTEM). He conducts short courses all over the world in *Geomorphic Analysis of Fluvial Systems* and in the *Application of BSTEM*. His field research has taken him to Australia, New Zealand, Europe, Asia and across North America. Dr. Simon is an adjunct Professor at the University of Mississippi and Special Professor in the School of Geography, University of Nottingham, UK. He brings to the project a veteran team of engineers and field technicians to support field-data collection activities, analysis and modelling.

## **YAVUZ OZEREN, PhD, PE**

Dr. Yavuz Ozeren is a Research Scientist at the National Center for Computational Hydroscience and Engineering (NCCHE) of the University of Mississippi. Dr. Ozeren received his Ph.D. (2009) in Civil Engineering from the University of Mississippi and, M.S. (2002) and B.S. (1999) in Civil Engineering from the Middle East Technical University, Ankara, Turkey. Dr. Ozeren has been affiliated with the University of Mississippi since 2008. He has been collaborating with the United States Department of Agriculture (USDA), Agricultural Research Service (ARS) National Sedimentation Laboratory in several research projects involving laboratory and field experiments since 2004. His research interests lie in fluvial hydraulics, environmental fluid mechanics, and hydraulic and coastal engineering, and he has experience in field and laboratory studies as well as numerical modeling. Dr. Ozeren has numerous publications on journals and conferences. He is an active member of ASCE Environmental Water Resources Institute. He is the current chair of the Hydraulic measurements and Experimental Methods Technical Committee, and actively involved in the organization and planning of 2017 Hydraulic Measurements and Experimentation Conference. He is also a member of the International Association of Hydro-Environment Engineering and Research (IAHR), and AGU (American Geophysical Union).

## **KIT CHOI, PhD, PE**

Dr. Choi is a licensed civil engineer specializing in geotechnical engineering and civil design, soil mechanics and foundation engineering, dams, and geotechnical applications to water resources projects. He has two years of university teaching experience and over 31 years of experience in consulting engineering practice. He has worked on a wide range of geotechnical engineering projects, including foundation investigations for commercial and industrial buildings, dams, outlet works and spillway structures; analysis and design of braced excavation support systems; static and seismic slope stability analysis and deformation analysis; two-dimensional and three-dimensional liquefaction analysis; seepage and design of filters and drains; analysis and design of post-tensioned anchors; and rock slope stability analysis. Dr. Choi is experienced in the field investigations and design of levees, stream bank protection, stream stabilization, drainage improvements, coastal seawalls and boat docks, including subsurface investigations, field reconnaissance, geotechnical assessment, and preparation of construction drawings, and technical specifications. He has designed stream bank stabilization repairs using bio-engineering techniques such as bank barbs, anchored root wads, willows, and erosion control mats to enhance fisheries.

## **JENNIFER HAMMOND**

Jennifer Hammond has over 20 years of experience in the field of instream flow studies. Ms. Hammond has applied 1- and 2- dimensional hydraulic and habitat modelling for river habitat analysis and instream flow recommendations on rivers throughout the United States. With many years of experience in the collection of channel topography and hydraulic calibration information, and 1D/2D modelling Ms. Hammond brings valuable experience to an instream flow team. Experience includes the use of total stations (robotic and traditional), survey grade RTK GPS units, velocity meters (ADCP), laser levels, and hydro-acoustic equipment. Her hydraulic modelling experience includes HEC-RAS, PHABSIM based models and 2-dimensional finite element and finite volume models (e.g., River 2D, FESWMS, SRH-2D). Her other areas of expertise include HEC-RAS modelling for incremental dam failure and hazard analysis, salmonid bio-energetic data collection and modelling, fish passage data collection and analysis, and collection and analysis of split beam hydro-acoustic data for fish movement. In addition to Jennifer's extensive experience with hydraulic models and instream flow studies she has developed an expertise with the Bank-Stability and Toe-Erosion Model (BSTEM) with application on streams around the world.

## **NICK DANIS, PE**

Nick Danis has nine years of design experience on public and private projects. He prides himself on being technical and creative, with a proven track record of completing complex engineering tasks. Nick's resume includes stream restoration, wetland rehabilitation, storm water management, drainage systems, storm and sanitary sewer rehabilitation, roadway design, and residential and commercial development. In addition to Nick's extensive experience with engineering design and instream geomorphic studies, he has developed an expertise with the Bank-Stability and Toe-Erosion Model (BSTEM) with application on streams around the world. Nick's experience on rivers and streams includes the Pacific Northwest, East Coast, Mississippi River, Australia, and New Zealand. Nick often uses the output from various BSTEM models to influence the engineering design going forward, creating a seamless design balancing the need for bank stability with client goals and budgets. Nick's design software experience includes: AutoCAD Civil3D, Autodesk 3ds Max Design, ArcMap, BSTEM, xpswmm, HEC-RAS, and GeoHECRAS.

## **TIMOTHY SULLIVAN, GISP**

Mr. Sullivan's background focuses on the FERC regulatory environment, physical and environmental sciences, hydrology and hydraulics, technical writing, and Geographic Information Systems (GIS). Mr. Sullivan has served as a Project Manager, Deputy Project Manager, and/or Technical Lead for a number of FERC relicensing and compliance assignments related to both traditional and pumped storage hydroelectric projects throughout the Northeast and Mid-Atlantic. In addition, Mr. Sullivan has experience in the fields of geomorphology – including sediment transport and erosion dynamics, hydraulic modeling (HEC-RAS), and field data collection using various technologies. Mr. Sullivan is a licensed GIS Professional (GISP) with extensive experience in developing enterprise GIS solutions and conducting various geospatial analyses. Mr. Sullivan has overseen a variety of geology and soils related studies including those related to erosion causation, sediment management, sediment monitoring, and the water quality impacts of sedimentation.

## **JOHN HART**

Mr. Hart has over 25 years of water resource experience, including the last 15 years in FERC licensing as a water resources engineer / hydrologist and project manager on over 50 hydropower projects throughout the Northeast and the country. Mr. Hart has conducted and supervised numerous flood plain analyses, detailed watershed studies, headwater benefit studies, dam break analyses and dam redesigns; culvert analyses and designs; as well as specialized hydraulic studies including sediment transport and erosion. Mr. Hart has substantial hydropower related experience with most of these projects involving hydraulic and hydrologic modeling and developing FERC license related documents including PADs, study reports, or assisting FERC in preparation of their NEPA documents and license orders. Mr. Hart is well-versed in the computer modeling of surface and ground waters, including the use of HEC-1, HEC-2, HEC-5, HEC-RAS, HEC-ResSim, River2D, TR-55, TR-20, DAMBRK, FLDWAV, MODFLOW, MT3D, GMS, HMS, MODPATH, HWBEG, UNET, and similar models.

## **THOMAS SULLIVAN, PE**

Mr. Sullivan is a founding Principal of Gomez and Sullivan and a water resources engineer with 35 years of experience in river hydraulics as well as hydrologic and environmental assessments. He has B.S. and M.S. degrees in Environmental Engineering from the Pennsylvania State University, as well as a variety of continuing education courses in applied hydraulics and stream restoration techniques. Mr. Sullivan's areas of technical expertise include hydrologic and hydraulic analysis, instream flow analyses, and operations modeling. Over the course of his career, Mr. Sullivan has led field crews in the collection of hydraulic, habitat, and water quality data, as well as developed and calibrated hydraulic models that predict stream response to different scenarios. He has served as the Principal-in-Charge for projects to evaluate riverine hydraulics, shoreline erosion, and hydroelectric project operations.

## **MARK WAMSER, PE**

Mr. Wamser has 28 years of experience in FERC licensing and environmental and engineering studies. He has served as Project Manager for numerous FERC hydroelectric relicensing projects, as well as dam removal, water budgeting, watershed planning, water quality, and basin-wide modeling projects. In addition to his management experience, Mr. Wamser has considerable hands-on experience with operations modeling, energy analyses, instream flow studies (IFIM), water quality monitoring, fish passage analyses, impoundment level management studies, aesthetic studies, facilitation of settlement negotiations, and preparation of license applications for hydroelectric projects. Mr. Wamser's technical background includes

*Northfield Mountain Pumped Storage Project (No. 2485) and Turners Falls Hydroelectric Project (No. 1889)*  
STUDY 3.1.2 NORTHFIELD MOUNTAIN / TURNERS FALLS OPERATIONS IMPACTS ON EXISTING  
EROSION AND POTENTIAL BANK INSTABILITY

---

the development of simulation models of basin-wide river/reservoir systems, development of HEC-RAS hydraulic models for dam removal and flood inundation studies, watershed assessments and action plans, and general hydrologic investigations. Mr. Wamser has had formal training in risk management, PHABSIM, HEC-RAS, sediment transport, and USFWS field techniques for IFIM studies.

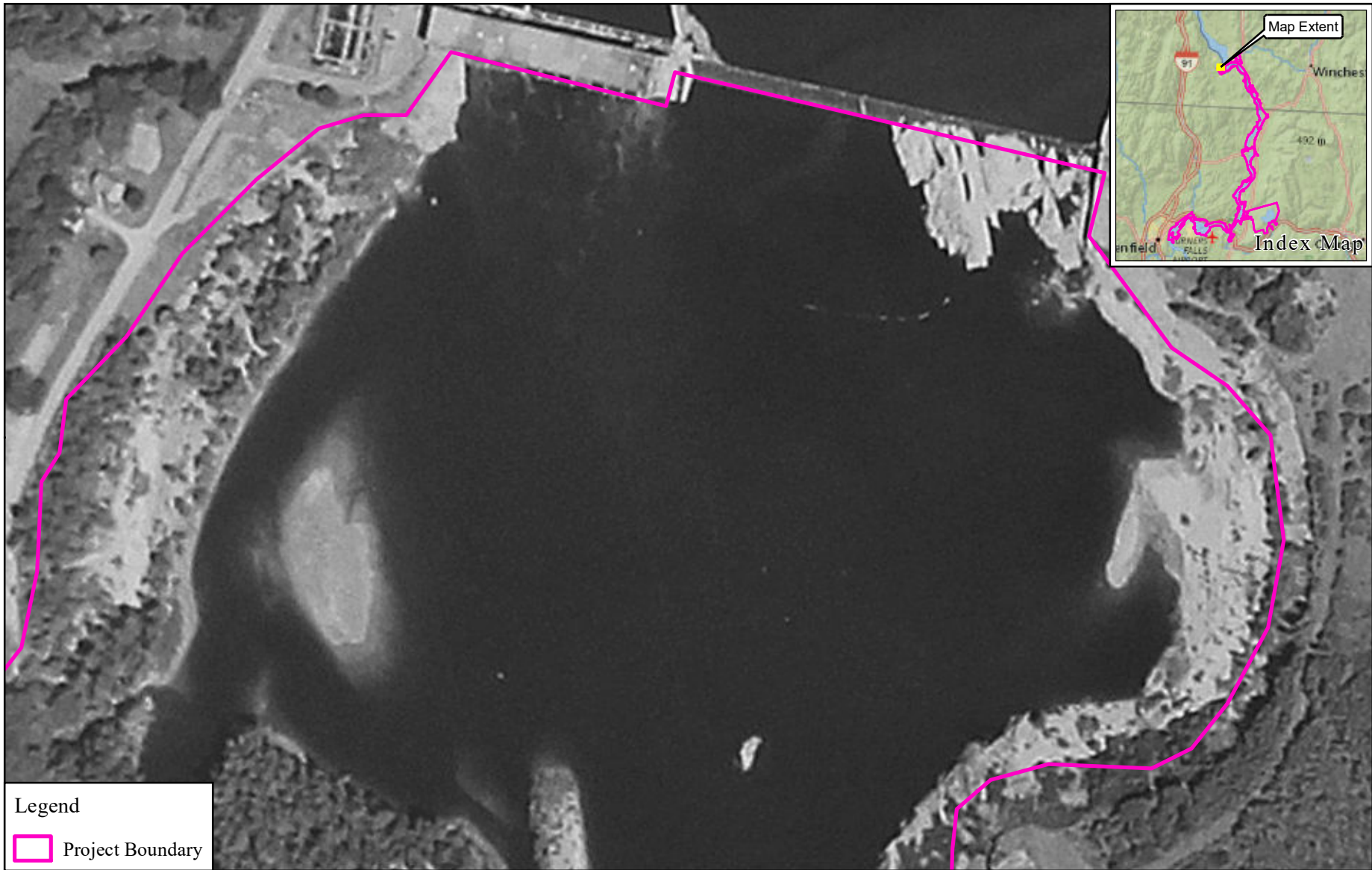


**APPENDIX B – HISTORIC AERIAL  
PHOTOS OF THE 20 SITES IDENTIFIED  
IN THE ECP**

## **1 VERNON DAM**

The most significant erosion feature in the Turners Falls Impoundment is located immediately downstream of Vernon Dam on the left bank (looking downstream). As discussed in S&A 2012, erosion occurs in this location due to the large eddy that forms from flow releases through Vernon Dam gates on the left side of the structure.

The 1952 photograph shows that the top of left bank is near the project boundary line (indicated in fuchsia). Recent photographs show that erosion has progressed beyond the line such that the bottom of the upper bank is beyond the line. The 2008-2010 and the Online Imagery were taken at relatively high flow conditions and show the turbulence and eddying associated with the release of flow through the left gates of Vernon Dam as well as the general turbulence in this reach of the river at these levels of flow.



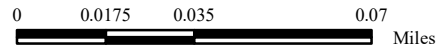
**Legend**

 Project Boundary




FIRSTLIGHT HYDRO GENERATING COMPANY  
 Northfield Mountain Pumped Storage Project No. 2485  
 Turners Falls Hydroelectric Project No. 1889

STUDY 3.1.2




Vernon Dam  
 1952 Imagery  
 (Source: North by Northeast Survey Company)

Copyright © 2016 FirstLight Power Resources All rights reserved.



**Legend**

 Project Boundary

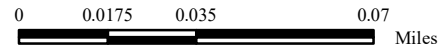


**FirstLight™**  
Power Resources



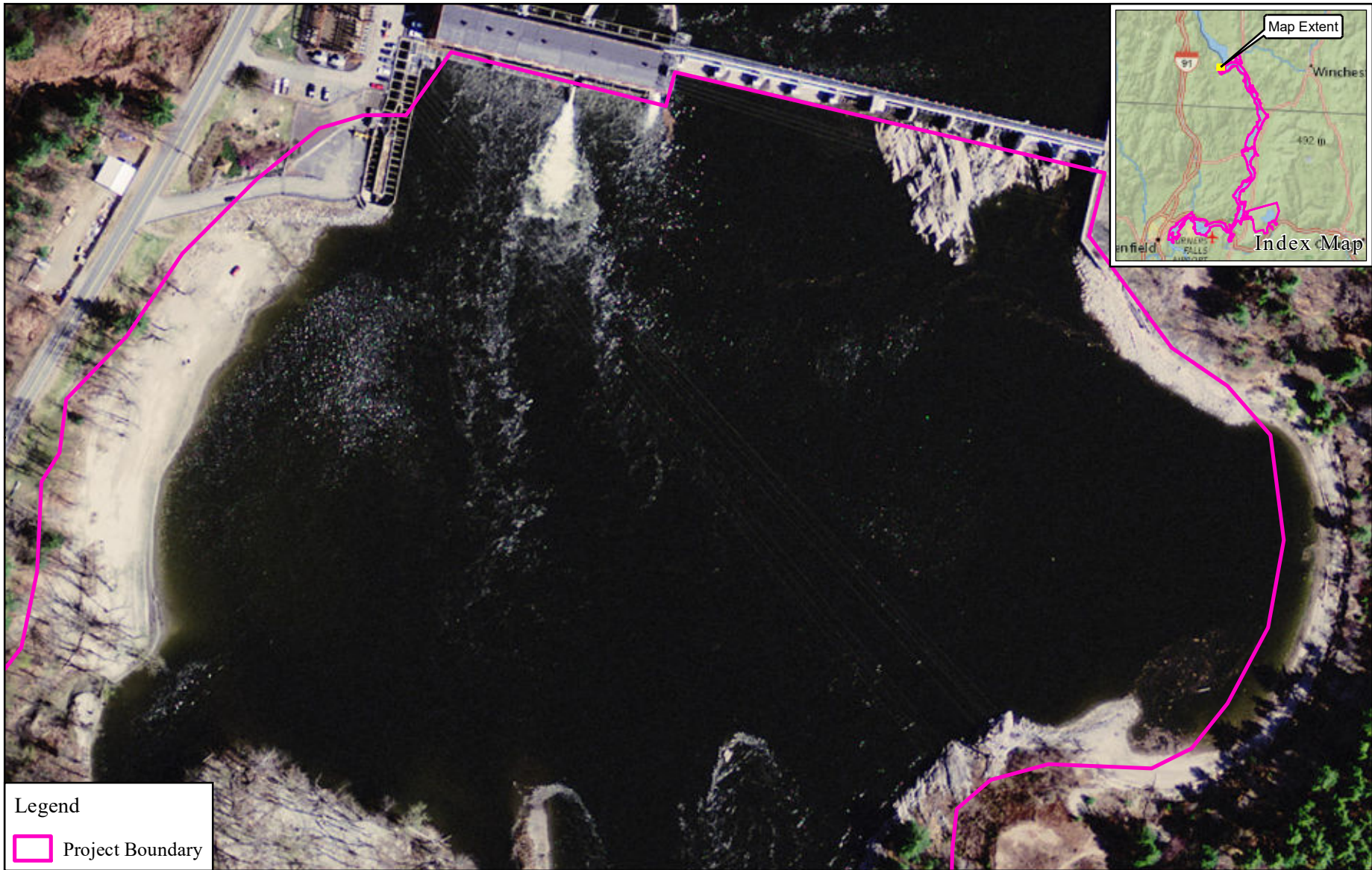
FIRSTLIGHT HYDRO GENERATING COMPANY  
Northfield Mountain Pumped Storage Project No. 2485  
Turners Falls Hydroelectric Project No. 1889

STUDY 3.1.2




Vernon Dam  
2008-2010 Imagery  
(Source: NH GRANIT)

Copyright © 2016 FirstLight Power Resources All rights reserved.



**Legend**

 Project Boundary

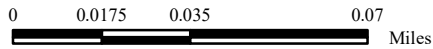


**FirstLight™**  
Power Resources



FIRSTLIGHT HYDRO GENERATING COMPANY  
Northfield Mountain Pumped Storage Project No. 2485  
Turners Falls Hydroelectric Project No. 1889

STUDY 3.1.2

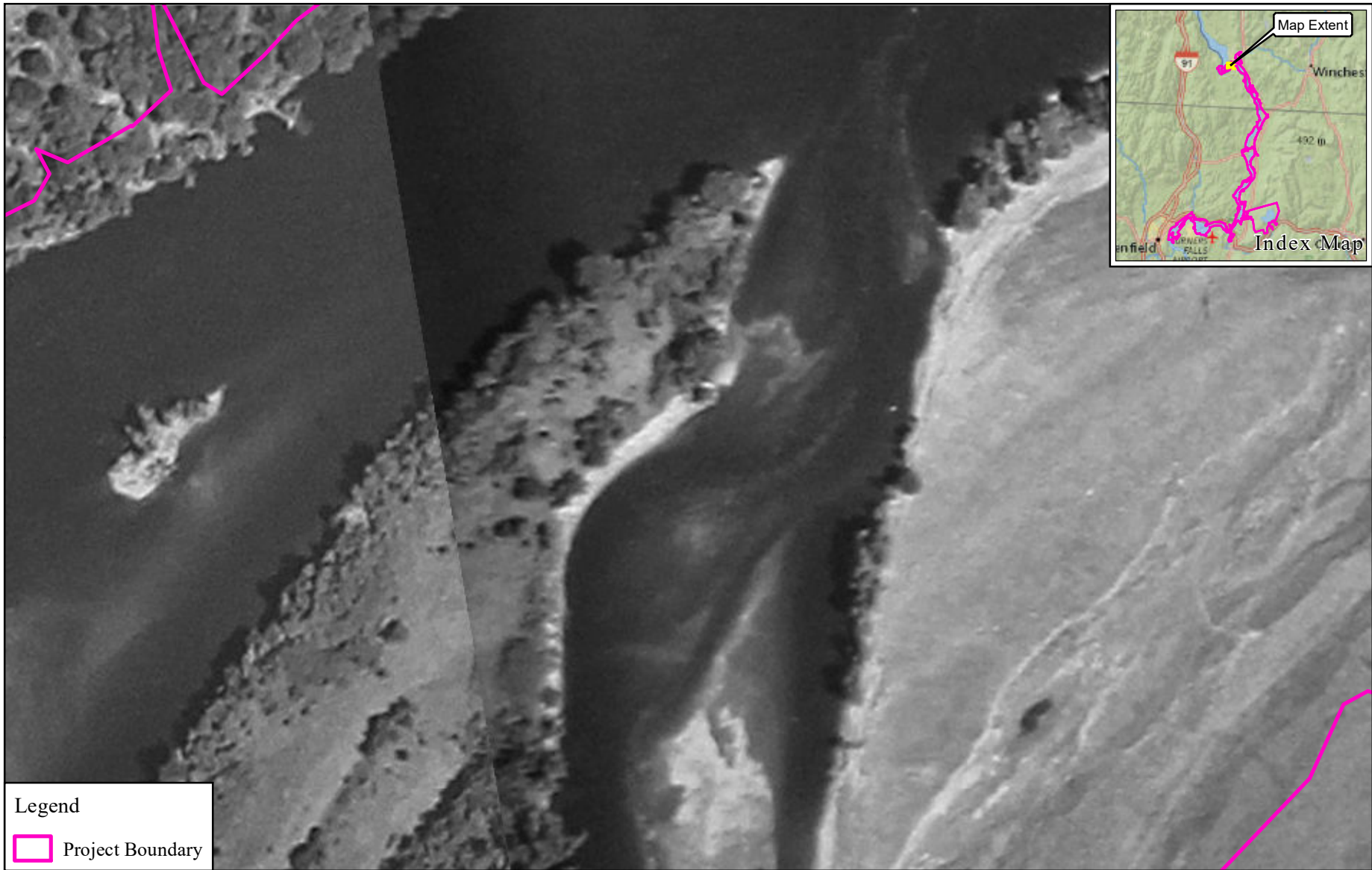


Vernon Dam  
2014 Imagery  
(Source: NAIP)

Copyright © 2016 FirstLight Power Resources All rights reserved.

## **2 STEBBINS ISLAND**

The 1952 photograph shows that there is little vegetation along the right bank of the river, bars and small vegetated islands to the left of the main island, and shallow flow conditions on both sides of the island. By the 2008-2010 set of photos, the downstream tip of the island had narrowed but the potentially eroded right bank which in 1952 had little to no vegetation on the bank had some establishment of vegetation on the bank. The 2014 and Online Imagery are similar to the 2008-2010 photograph.



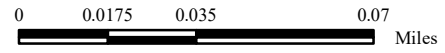
Legend

 Project Boundary




FIRSTLIGHT HYDRO GENERATING COMPANY  
 Northfield Mountain Pumped Storage Project No. 2485  
 Turners Falls Hydroelectric Project No. 1889

STUDY 3.1.2




Stebbins Island  
 1952 Imagery  
 (Source: North by Northeast Survey Company)


Copyright © 2016 FirstLight Power Resources All rights reserved.



Legend

 Project Boundary

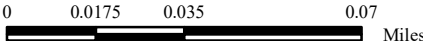




FIRSTLIGHT HYDRO GENERATING COMPANY  
 Northfield Mountain Pumped Storage Project No. 2485  
 Turners Falls Hydroelectric Project No. 1889

STUDY 3.1.2

Stebbins Island  
 2008-2010 Imagery  
 (Source: NH GRANIT)



Miles

Copyright © 2016 FirstLight Power Resources All rights reserved.





Legend

 Project Boundary

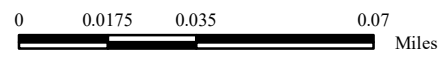


**FirstLight**<sup>™</sup>  
Power Resources



FIRSTLIGHT HYDRO GENERATING COMPANY  
Northfield Mountain Pumped Storage Project No. 2485  
Turners Falls Hydroelectric Project No. 1889

STUDY 3.1.2

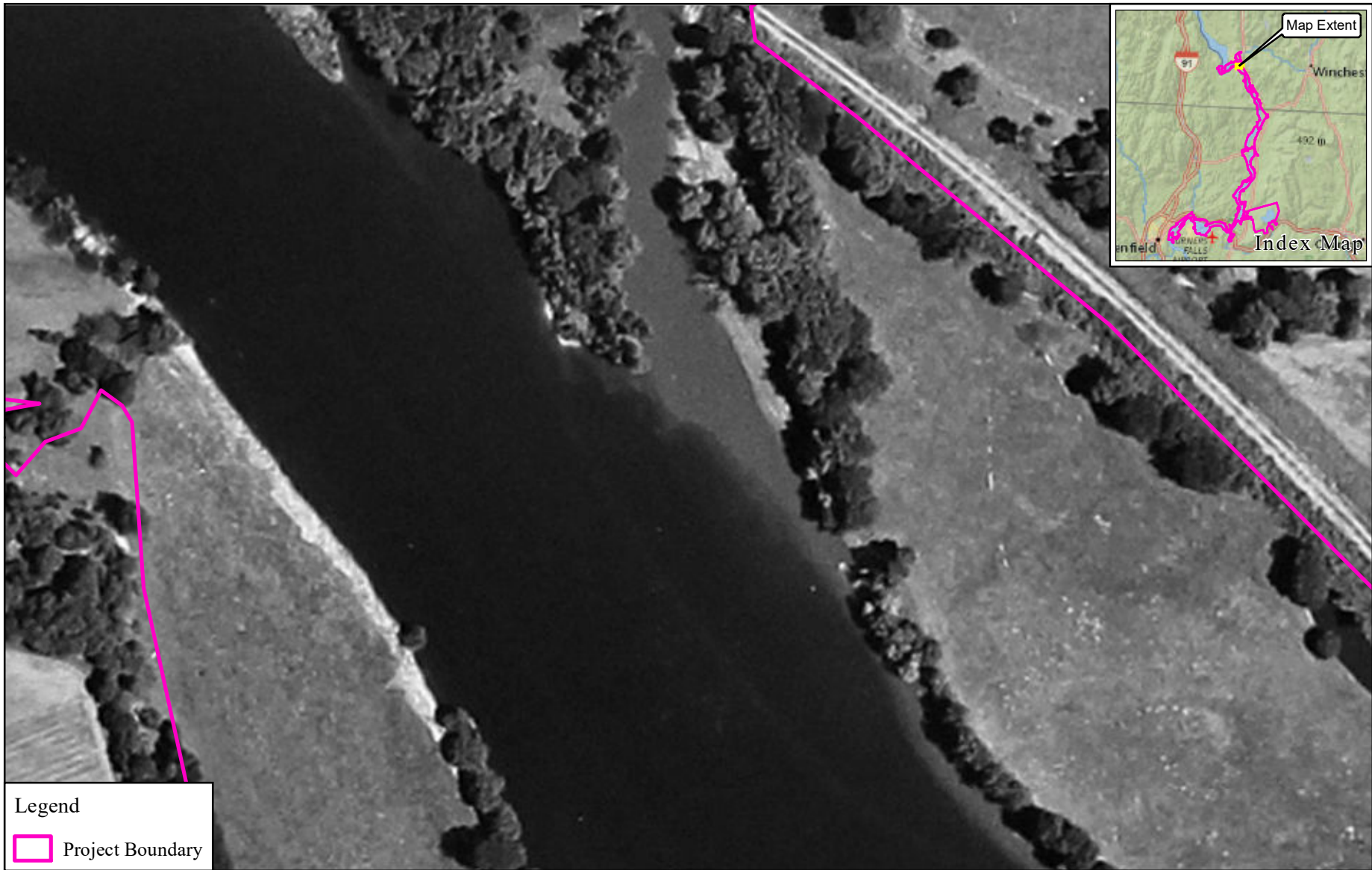


Stebbins Island  
2014 Imagery  
(Source: NAIP)

Copyright © 2016 FirstLight Power Resources All rights reserved.

### **3 ASHUELOT RIVER CONFLUENCE**

The 1952 photograph shows that the right bank of the river, opposite the confluence with the Ashuelot River, is eroded with no upper riverbank vegetation between the agricultural field and the river. The 2008-2010 and other recent photographs show an increase in riverbank vegetation along this same section of riverbank. On the Ashuelot side, upstream of the confluence the tip of land appears to have narrowed over time since 1952 and there is some decrease in the narrow riparian zone of upper riverbank vegetation downstream of the confluence.



Legend

 Project Boundary

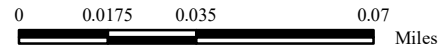


**FirstLight**<sup>™</sup>  
Power Resources



FIRSTLIGHT HYDRO GENERATING COMPANY  
 Northfield Mountain Pumped Storage Project No. 2485  
 Turners Falls Hydroelectric Project No. 1889

STUDY 3.1.2




Ashuelot River Confluence  
 1952 Imagery  
 (Source: North by Northeast Survey Company)

Copyright © 2016 FirstLight Power Resources All rights reserved.



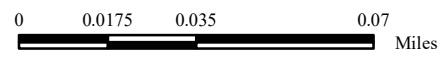
**Legend**

 Project Boundary



FIRSTLIGHT HYDRO GENERATING COMPANY  
 Northfield Mountain Pumped Storage Project No. 2485  
 Turners Falls Hydroelectric Project No. 1889

**STUDY 3.1.2**



**Ashuelot River Confluence**  
 2008-2010 Imagery  
 (Source: NH GRANIT)

Copyright © 2016 FirstLight Power Resources All rights reserved.



**Legend**

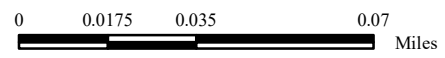
 Project Boundary



**FirstLight™**  
Power Resources



FIRSTLIGHT HYDRO GENERATING COMPANY  
 Northfield Mountain Pumped Storage Project No. 2485  
 Turners Falls Hydroelectric Project No. 1889  
**STUDY 3.1.2**

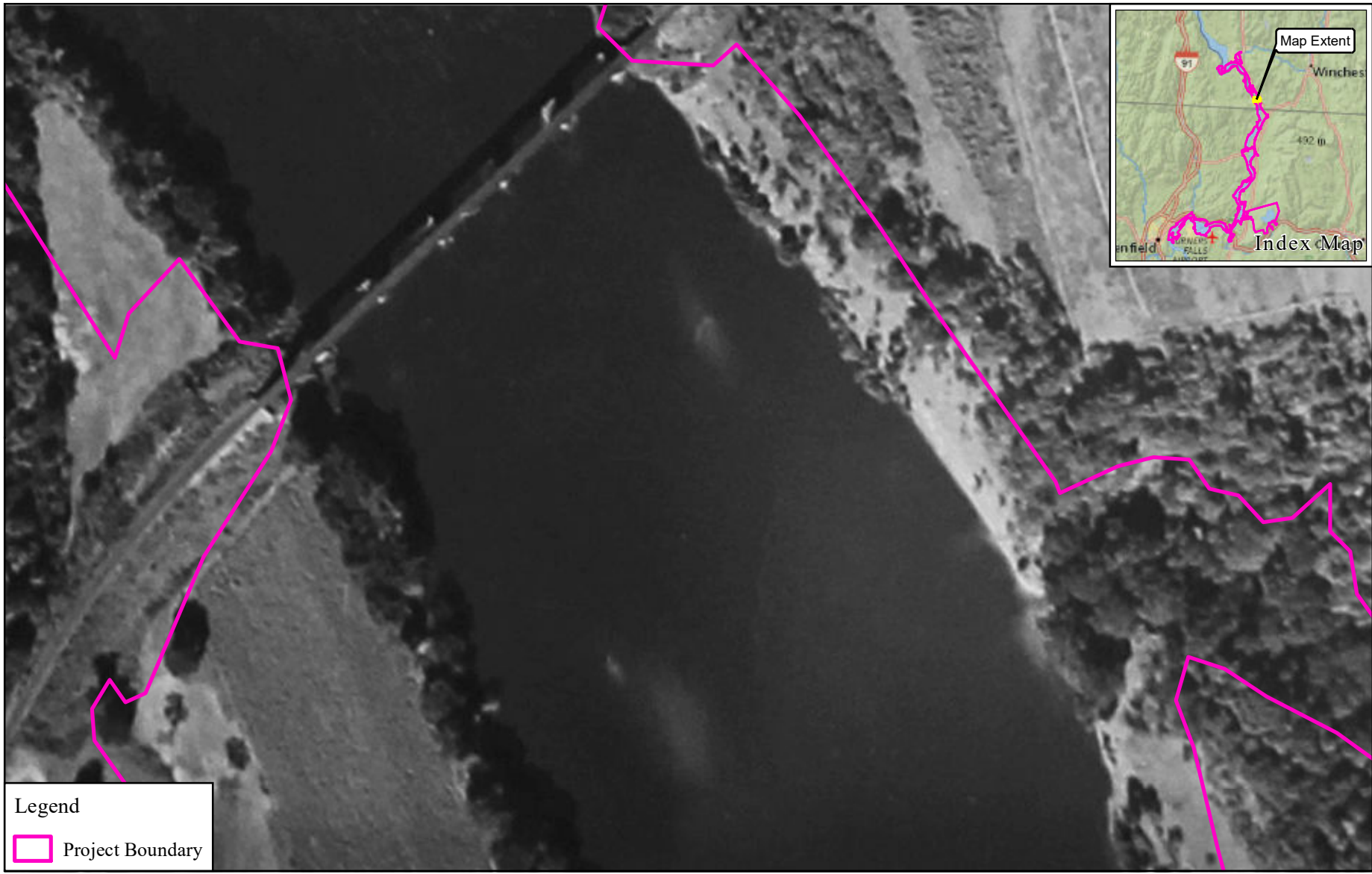


Ashuelot River Confluence  
 2014 Imagery  
 (Source: NAIP)


Copyright © 2016 FirstLight Power Resources All rights reserved.

#### **4 KENDALL**

In the vicinity of the railroad bridge which has been subsequently abandoned and partially removed, in 1952 the right bank downstream of the bridge supports a band of riparian vegetation while the left bank is sparsely vegetated. In 1962, in the same location on the right bank erosion is evident with the bank shifting landward and no riparian vegetation remaining. On the left bank, a small erosion scallop has formed just downstream of the bridge with segments of reduced riparian vegetation. The bridge super-structure had been removed by the 1990s photograph, with all piers left standing in the river. By the 2008-2010 set of photographs, one of the piers had fallen into the river, probably due to scour around its base and no supporting structure to provide stability from above. The right bank is the Kendall site which was stabilized in 2008 through implementation of the ECP. Subsequent photos show the stabilized right bank and increased riparian vegetation along the left bank.



**Legend**

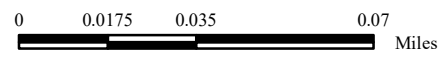
 Project Boundary



**FirstLight™**  
Power Resources



FIRSTLIGHT HYDRO GENERATING COMPANY  
 Northfield Mountain Pumped Storage Project No. 2485  
 Turners Falls Hydroelectric Project No. 1889  
**STUDY 3.1.2**



Kendall  
 1952 Imagery  
 (Source: North by Northeast Survey Company)

Copyright © 2016 FirstLight Power Resources All rights reserved.



**Legend**

 Project Boundary

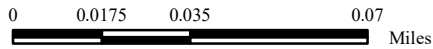


**FirstLight**<sup>™</sup>  
Power Resources



FIRSTLIGHT HYDRO GENERATING COMPANY  
Northfield Mountain Pumped Storage Project No. 2485  
Turners Falls Hydroelectric Project No. 1889

STUDY 3.1.2




Kendall  
1960's Imagery  
(Source: USGS)

Copyright © 2016 FirstLight Power Resources All rights reserved.





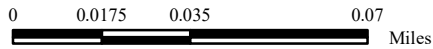
**Legend**

 Project Boundary




FIRSTLIGHT HYDRO GENERATING COMPANY  
 Northfield Mountain Pumped Storage Project No. 2485  
 Turners Falls Hydroelectric Project No. 1889

STUDY 3.1.2




Kendall  
 1990's Imagery  
 (Source: MassGIS)

Copyright © 2016 FirstLight Power Resources All rights reserved.

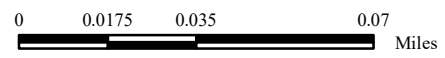


**Legend**

 Project Boundary




FIRSTLIGHT HYDRO GENERATING COMPANY  
 Northfield Mountain Pumped Storage Project No. 2485  
 Turners Falls Hydroelectric Project No. 1889  
**STUDY 3.1.2**




Kendall  
 2008-2010 Imagery  
 (Source: NH GRANIT)

Copyright © 2016 FirstLight Power Resources All rights reserved.



**Legend**

 Project Boundary

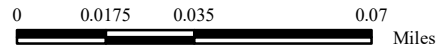


**FirstLight™**  
Power Resources



FIRSTLIGHT HYDRO GENERATING COMPANY  
Northfield Mountain Pumped Storage Project No. 2485  
Turners Falls Hydroelectric Project No. 1889

STUDY 3.1.2

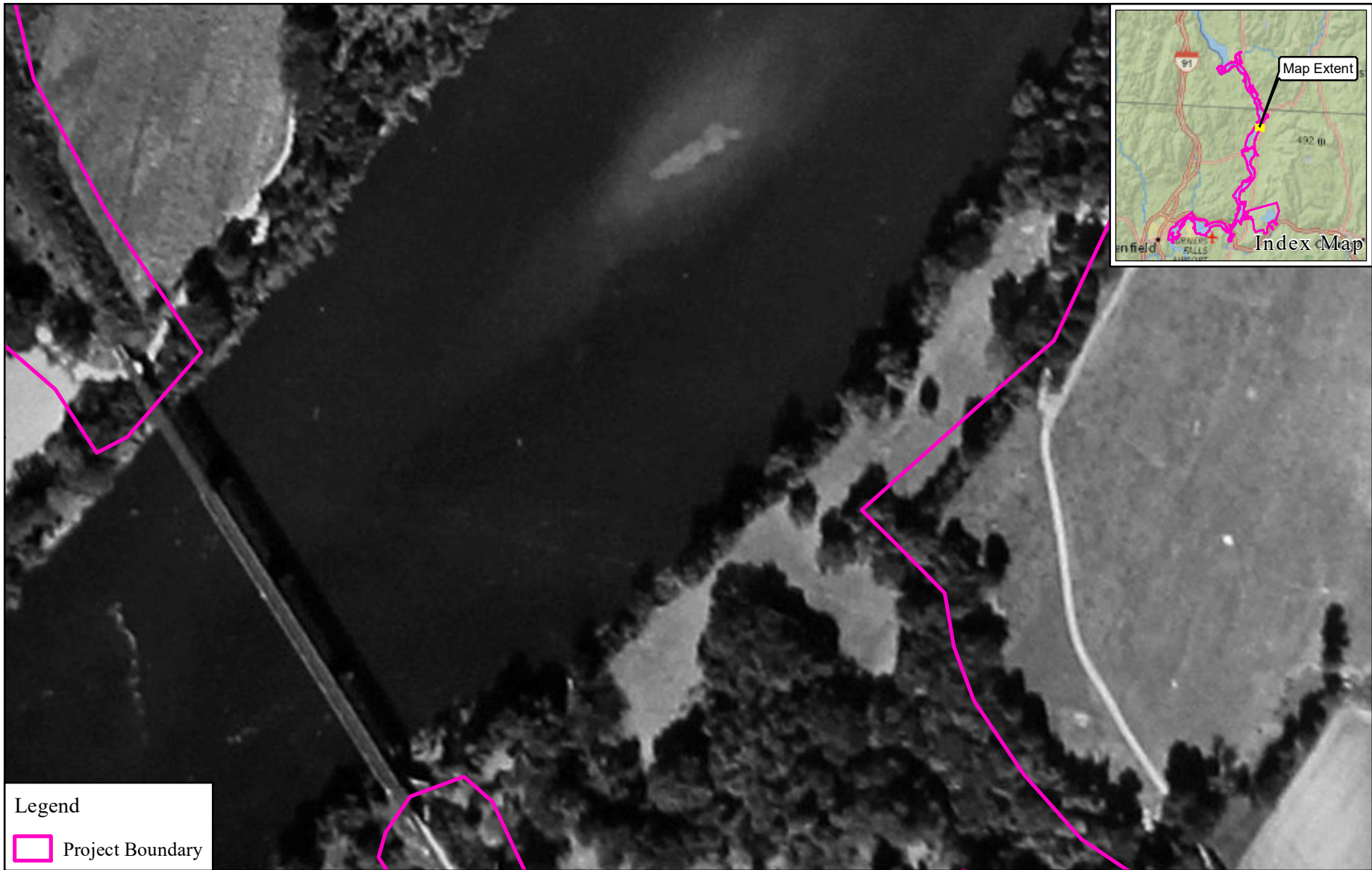


Kendall  
2014 Imagery  
(Source: NAIP)


Copyright © 2016 FirstLight Power Resources All rights reserved.



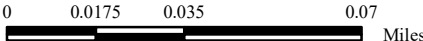
## **5 SCHELL BRIDGE (COUNTRY ROAD)**

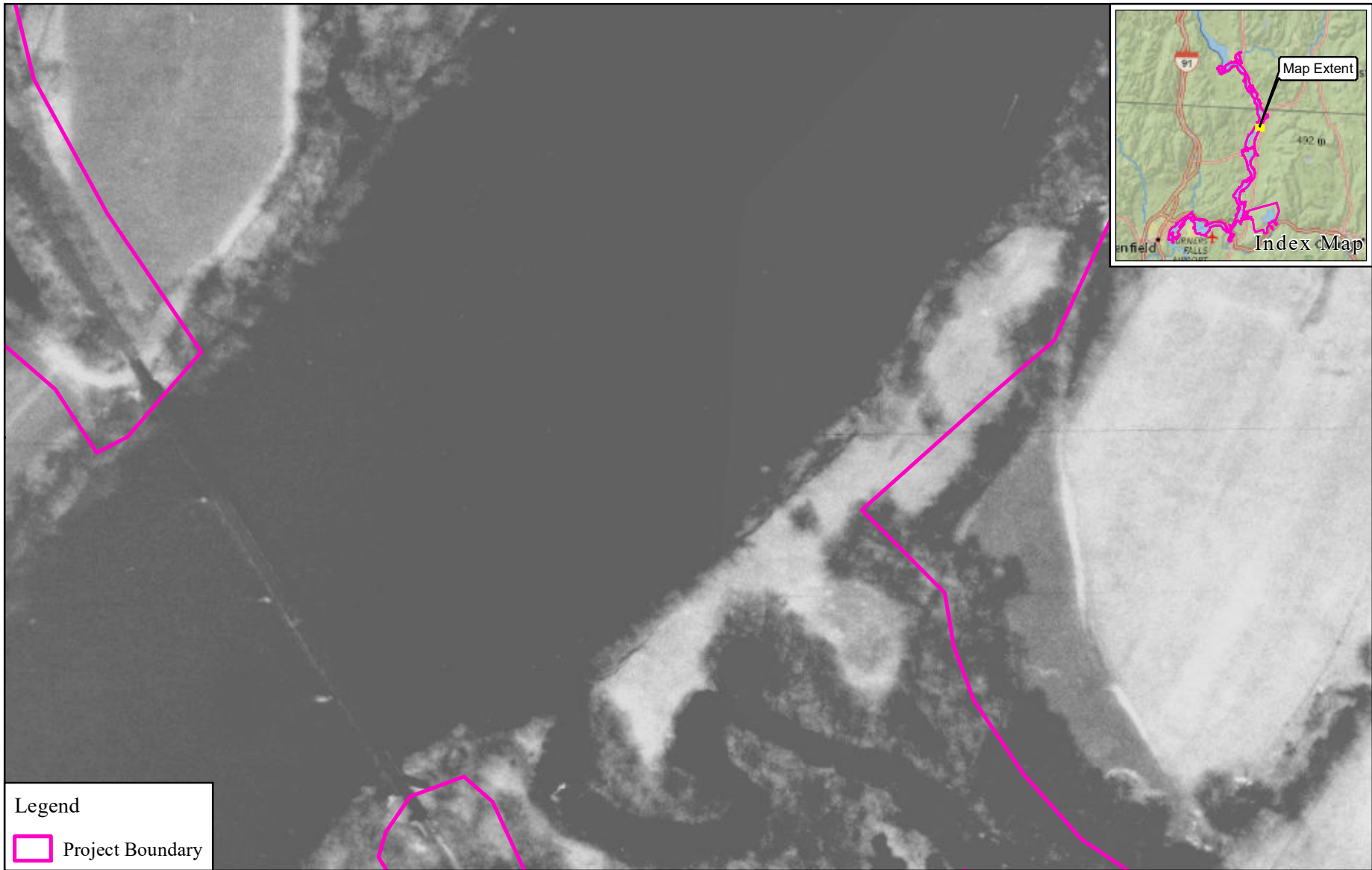
In the 1952 photograph, a band of riparian vegetation is found along both banks of the river upstream of the Schell Bridge. The extent of vegetation appears to be relatively consistent along the right bank through the series of photographs. On the left bank; however, the 1960s photograph shows erosion and a significant reduction in riparian vegetation. This area was called the Country Road Site, which was stabilized in 2006 through the ECP as shown in the 2008-2010 and more recent photographs.



**Legend**

 Project Boundary

	<p>FIRSTLIGHT HYDRO GENERATING COMPANY          Northfield Mountain Pumped Storage Project No. 2485          Turners Falls Hydroelectric Project No. 1889</p> <p><b>STUDY 3.1.2</b></p>	<p>Schell Bridge (Country Road)          1952 Imagery          (Source: North by Northeast Survey Company)</p>
		<p><small>Copyright © 2016 FirstLight Power Resources All rights reserved.</small></p>



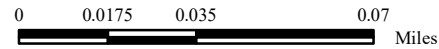
**Legend**

 Project Boundary




FIRSTLIGHT HYDRO GENERATING COMPANY  
 Northfield Mountain Pumped Storage Project No. 2485  
 Turners Falls Hydroelectric Project No. 1889

**STUDY 3.1.2**



Schell Bridge (Country Road)  
 1960's Imagery  
 (Source: USGS)

Copyright © 2016 FirstLight Power Resources All rights reserved.



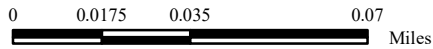
**Legend**

 Project Boundary




FIRSTLIGHT HYDRO GENERATING COMPANY  
 Northfield Mountain Pumped Storage Project No. 2485  
 Turners Falls Hydroelectric Project No. 1889

**STUDY 3.1.2**



Schell Bridge (Country Road)  
 1990's Imagery  
 (Source: MassGIS)

Copyright © 2016 FirstLight Power Resources All rights reserved.



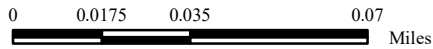
**Legend**

 Project Boundary




FIRSTLIGHT HYDRO GENERATING COMPANY  
 Northfield Mountain Pumped Storage Project No. 2485  
 Turners Falls Hydroelectric Project No. 1889

STUDY 3.1.2




Schell Bridge (Country Road)  
 2008-2010 Imagery  
 (Source: VCGI)

Copyright © 2016 FirstLight Power Resources All rights reserved.





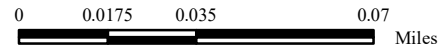
**Legend**

 Project Boundary




FIRSTLIGHT HYDRO GENERATING COMPANY  
 Northfield Mountain Pumped Storage Project No. 2485  
 Turners Falls Hydroelectric Project No. 1889

**STUDY 3.1.2**

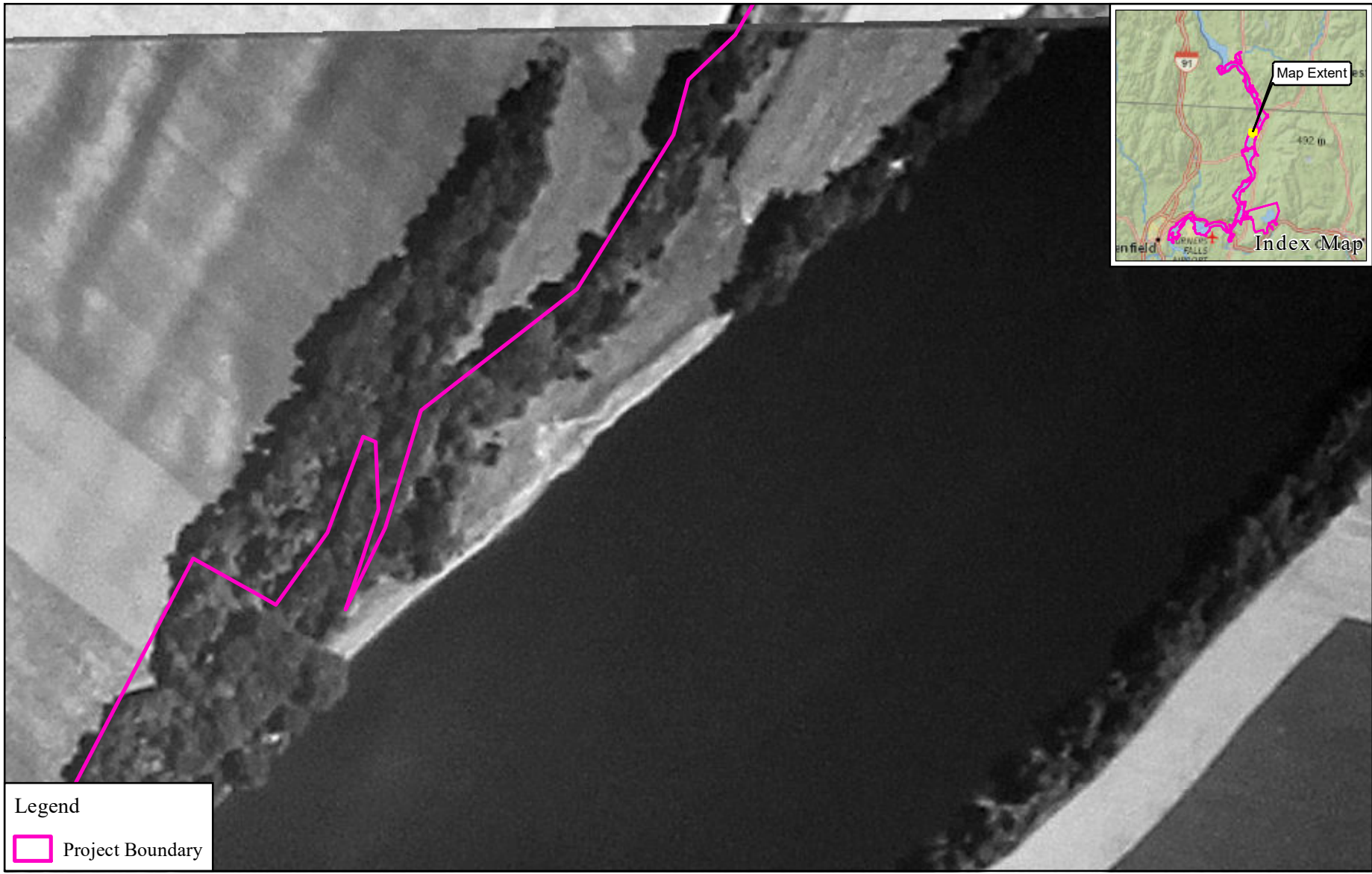


Schell Bridge (Country Road)  
 2014 Imagery  
 (Source: NAIP)


Copyright © 2016 FirstLight Power Resources All rights reserved.

## **6 WICKEY**

In the 1952 and 1960s photographs, there is an eroded section of riverbank with no significant riparian vegetation. During the 1990s, this site was selected for erosion repair, known as the Wickey site (constructed in 1996).

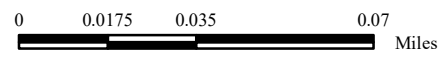


**Legend**

 Project Boundary

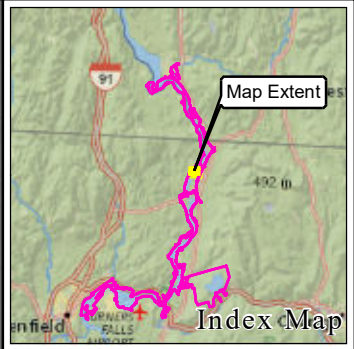


FIRSTLIGHT HYDRO GENERATING COMPANY  
 Northfield Mountain Pumped Storage Project No. 2485  
 Turners Falls Hydroelectric Project No. 1889  
**STUDY 3.1.2**



Wickey  
 1952 Imagery  
 (Source: North by Northeast Survey Company)

Copyright © 2016 FirstLight Power Resources All rights reserved.



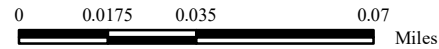
**Legend**

 Project Boundary




FIRSTLIGHT HYDRO GENERATING COMPANY  
 Northfield Mountain Pumped Storage Project No. 2485  
 Turners Falls Hydroelectric Project No. 1889

**STUDY 3.1.2**




Wickey  
 1960's Imagery  
 (Source: USGS)

Copyright © 2016 FirstLight Power Resources All rights reserved.



Legend

 Project Boundary

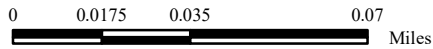


**FirstLight**<sup>™</sup>  
Power Resources



FIRSTLIGHT HYDRO GENERATING COMPANY  
Northfield Mountain Pumped Storage Project No. 2485  
Turners Falls Hydroelectric Project No. 1889

STUDY 3.1.2



Wickey  
1990's Imagery  
(Source: MassGIS)

Copyright © 2016 FirstLight Power Resources All rights reserved.



**Legend**

 Project Boundary

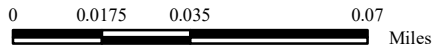


**FirstLight**  
Power Resources



FIRSTLIGHT HYDRO GENERATING COMPANY  
 Northfield Mountain Pumped Storage Project No. 2485  
 Turners Falls Hydroelectric Project No. 1889

STUDY 3.1.2



Wickey  
 2008-2010 Imagery  
 (Source: VCGI)

Copyright © 2016 FirstLight Power Resources All rights reserved.



**Legend**

 Project Boundary

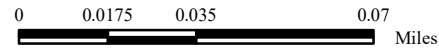


**FirstLight**<sup>™</sup>  
Power Resources



FIRSTLIGHT HYDRO GENERATING COMPANY  
Northfield Mountain Pumped Storage Project No. 2485  
Turners Falls Hydroelectric Project No. 1889

**STUDY 3.1.2**



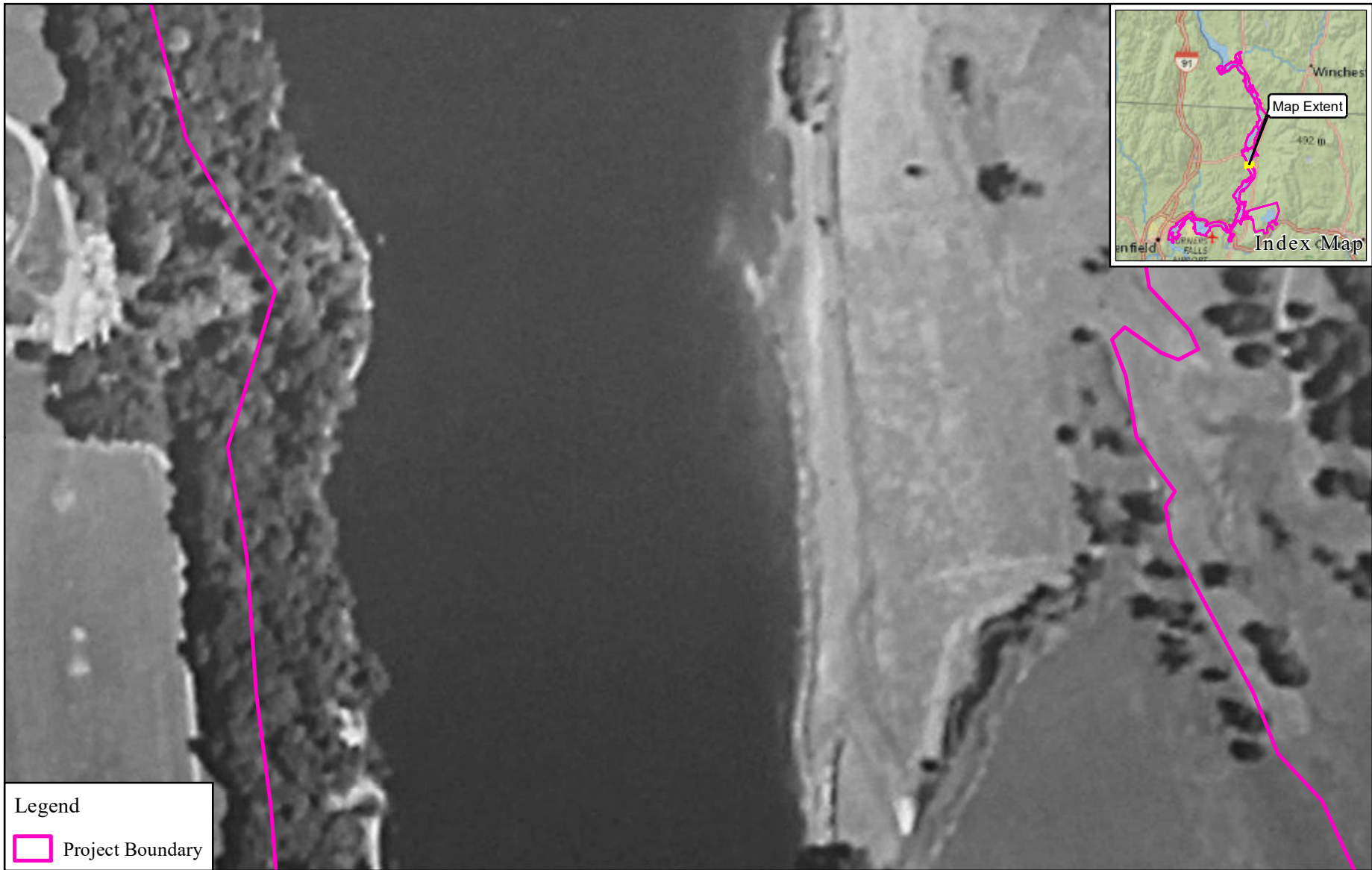
Wickey  
2014 Imagery  
(Source: NAIP)

Copyright © 2016 FirstLight Power Resources All rights reserved.

## **7 MT. HERMON**

The left riverbank across the river from the Mt. Hermon School was eroded and absent riparian vegetation on the 1952 and 1960s photographs. A strip of riparian vegetation has become established along this riverbank as can be seen in the 1990s and subsequent photographs.





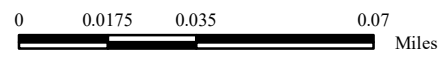
**Legend**

 Project Boundary



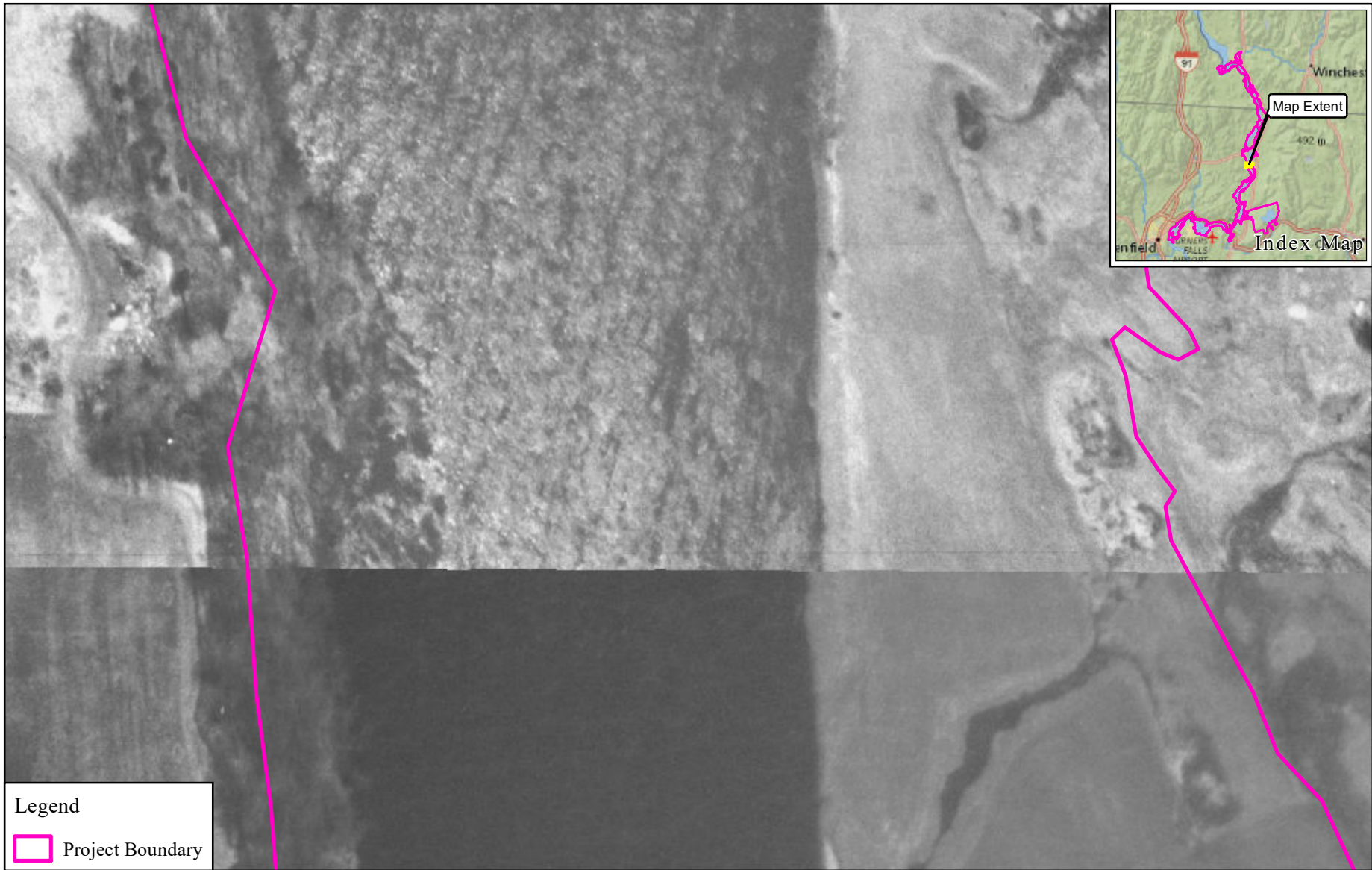

FIRSTLIGHT HYDRO GENERATING COMPANY  
 Northfield Mountain Pumped Storage Project No. 2485  
 Turners Falls Hydroelectric Project No. 1889

STUDY 3.1.2




Mt. Hermon  
 1952 Imagery  
 (Source: North by Northeast Survey Company)

Copyright © 2016 FirstLight Power Resources All rights reserved.



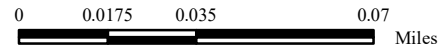
**Legend**

 Project Boundary




FIRSTLIGHT HYDRO GENERATING COMPANY  
 Northfield Mountain Pumped Storage Project No. 2485  
 Turners Falls Hydroelectric Project No. 1889

STUDY 3.1.2




Mt. Hermon  
 1960's Imagery  
 (Source: USGS)

Copyright © 2016 FirstLight Power Resources All rights reserved.



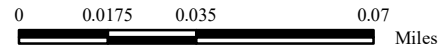
**Legend**

 Project Boundary



FIRSTLIGHT HYDRO GENERATING COMPANY  
 Northfield Mountain Pumped Storage Project No. 2485  
 Turners Falls Hydroelectric Project No. 1889

STUDY 3.1.2




Mt. Hermon  
 1990's Imagery  
 (Source: MassGIS)

Copyright © 2016 FirstLight Power Resources All rights reserved.



**Legend**

 Project Boundary

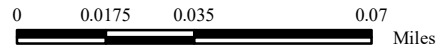


**FirstLight**<sup>™</sup>  
Power Resources



FIRSTLIGHT HYDRO GENERATING COMPANY  
 Northfield Mountain Pumped Storage Project No. 2485  
 Turners Falls Hydroelectric Project No. 1889

STUDY 3.1.2



Mt. Hermon  
 2008-2010 Imagery  
 (Source: MassGIS)

Copyright © 2016 FirstLight Power Resources All rights reserved.



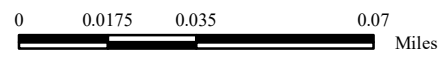
**Legend**

 Project Boundary



FIRSTLIGHT HYDRO GENERATING COMPANY  
 Northfield Mountain Pumped Storage Project No. 2485  
 Turners Falls Hydroelectric Project No. 1889

STUDY 3.1.2



Mt. Hermon  
 2014 Imagery  
 (Source: NAIP)

Copyright © 2016 FirstLight Power Resources All rights reserved.

## **8 ROUTE 10 BRIDGE**

The 1952 photo shows some riparian vegetation along both banks but curvature of both banks suggests erosion has been occurring. In “Analysis of Erosion in the Vicinity of the Route 10 Bridge Spanning the Connecticut River,” Simons & Associates 2012 even earlier photos were included in the analysis:




*The series of aerial photographs show that erosion was occurring progressively during the entire period from 1929 to 1990 on both riverbanks focused primarily in the area downstream of the old Bennett Meadow Bridge. Erosion is evident during the entire sequence of aerial photographs from 1929 through 1990 and erosion was progressing prior to raising the Turners Falls Dam in 1972 and before the construction and operation of the Northfield Mountain Pumped Storage Project.*

The right bank upstream of the bridge was stabilized in 1997 (Crooker) and no additional stabilization was conducted because of the unique and extreme hydraulics associated with the river in this reach where the bridge is located.



Legend

 Project Boundary

	<p>FIRSTLIGHT HYDRO GENERATING COMPANY          Northfield Mountain Pumped Storage Project No. 2485          Turners Falls Hydroelectric Project No. 1889</p> <p>STUDY 3.1.2</p> <p>0    0.0175    0.035    0.07   Miles</p>	<p>Rt. 10 Bridge          1952 Imagery          (Source: North by Northeast Survey Company)</p>
		
Copyright © 2016 FirstLight Power Resources All rights reserved.		



**Legend**

 Project Boundary

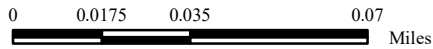


**FirstLight**<sup>™</sup>  
Power Resources



FIRSTLIGHT HYDRO GENERATING COMPANY  
 Northfield Mountain Pumped Storage Project No. 2485  
 Turners Falls Hydroelectric Project No. 1889

STUDY 3.1.2




Rt. 10 Bridge  
 1960's Imagery  
 (Source: USGS)

Copyright © 2016 FirstLight Power Resources All rights reserved.





**Legend**

 Project Boundary

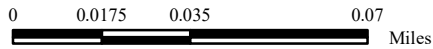


**FirstLight**  
Power Resources



FIRSTLIGHT HYDRO GENERATING COMPANY  
 Northfield Mountain Pumped Storage Project No. 2485  
 Turners Falls Hydroelectric Project No. 1889

STUDY 3.1.2




Rt. 10 Bridge  
 1990's Imagery  
 (Source: MassGIS)

Copyright © 2016 FirstLight Power Resources All rights reserved.



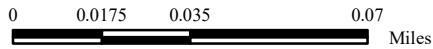
**Legend**

 Project Boundary




FIRSTLIGHT HYDRO GENERATING COMPANY  
 Northfield Mountain Pumped Storage Project No. 2485  
 Turners Falls Hydroelectric Project No. 1889

STUDY 3.1.2




Rt. 10 Bridge  
 2008-2010 Imagery  
 (Source: MassGIS)

Copyright © 2016 FirstLight Power Resources All rights reserved.



**Legend**

 Project Boundary

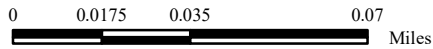


**FirstLight™**  
Power Resources



FIRSTLIGHT HYDRO GENERATING COMPANY  
Northfield Mountain Pumped Storage Project No. 2485  
Turners Falls Hydroelectric Project No. 1889

STUDY 3.1.2

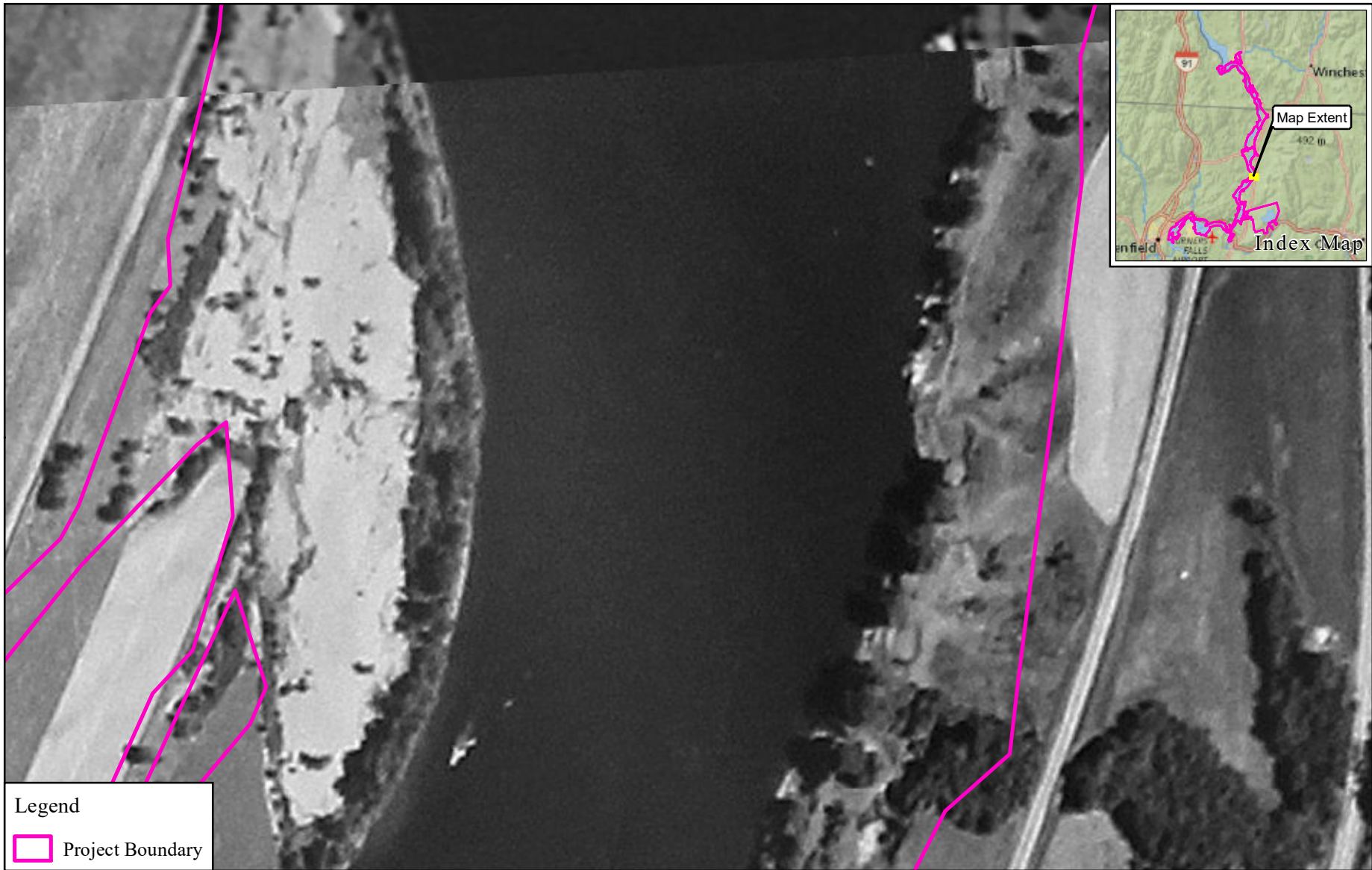


Rt. 10 Bridge  
2014 Imagery  
(Source: NAIP)

Copyright © 2016 FirstLight Power Resources All rights reserved.

## **9 URGIEL**

At a bend in the river upstream of Kidds Island the 1952 photograph shows a reach with some riparian vegetation. The 1960s photograph shows erosion and associated decrease in riparian vegetation. The right bank is the Urgiel downstream site which was stabilized in 2005 as shown in the 2008-2010 and subsequent photographs. The riparian vegetation has become denser over the years on the right bank.



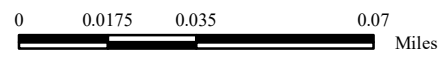
**Legend**

 Project Boundary



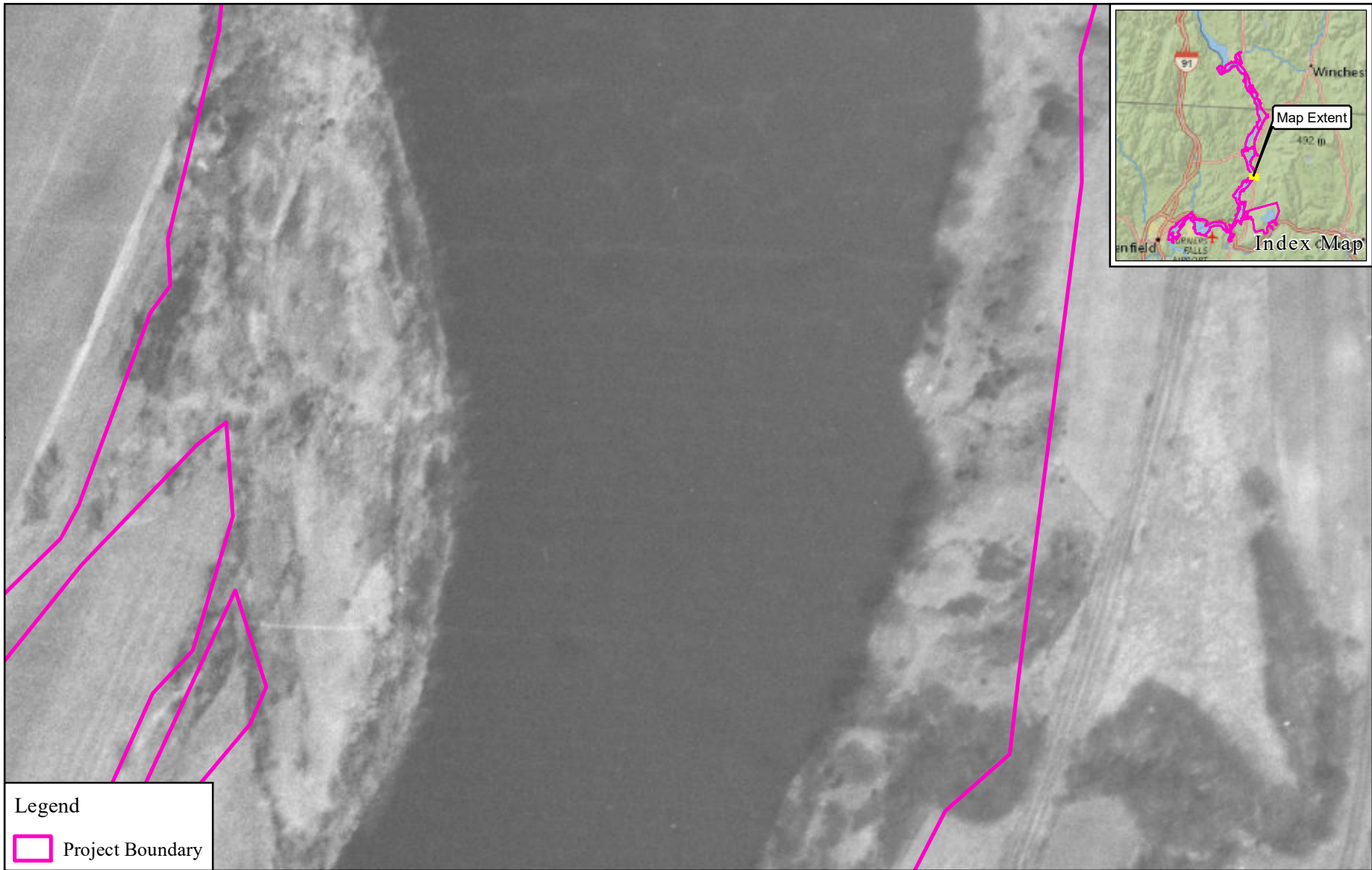
FIRSTLIGHT HYDRO GENERATING COMPANY  
 Northfield Mountain Pumped Storage Project No. 2485  
 Turners Falls Hydroelectric Project No. 1889

**STUDY 3.1.2**



Urgiel  
 1952 Imagery  
 (Source: North by Northeast Survey Company)

Copyright © 2016 FirstLight Power Resources All rights reserved.



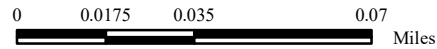
**Legend**

 Project Boundary



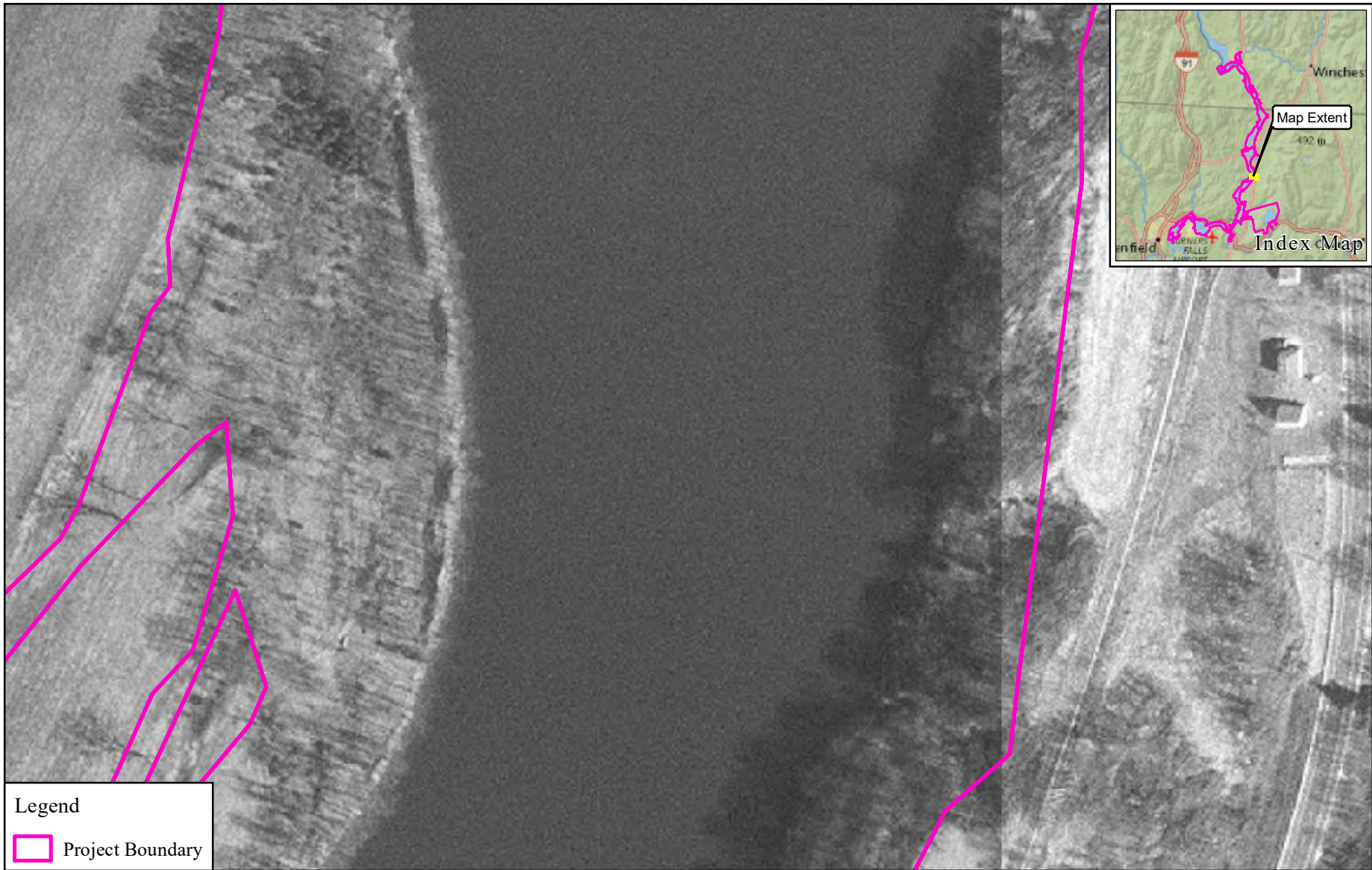

FIRSTLIGHT HYDRO GENERATING COMPANY  
 Northfield Mountain Pumped Storage Project No. 2485  
 Turners Falls Hydroelectric Project No. 1889

STUDY 3.1.2




Urgiel  
 1960's Imagery  
 (Source: USGS)

Copyright © 2016 FirstLight Power Resources All rights reserved.



**Legend**

 Project Boundary

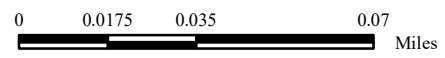


**FirstLight**<sup>™</sup>  
Power Resources



FIRSTLIGHT HYDRO GENERATING COMPANY  
Northfield Mountain Pumped Storage Project No. 2485  
Turners Falls Hydroelectric Project No. 1889

STUDY 3.1.2



Urgiel  
1990's Imagery  
(Source: MassGIS)

Copyright © 2016 FirstLight Power Resources All rights reserved.



**Legend**

 Project Boundary

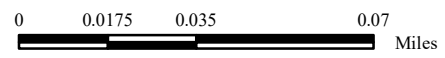


**FirstLight™**  
Power Resources



FIRSTLIGHT HYDRO GENERATING COMPANY  
 Northfield Mountain Pumped Storage Project No. 2485  
 Turners Falls Hydroelectric Project No. 1889

STUDY 3.1.2




Urgiel  
 2008-2010 Imagery  
 (Source: MassGIS)

Copyright © 2016 FirstLight Power Resources All rights reserved.





**Legend**

 Project Boundary

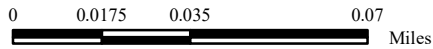


**FirstLight™**  
Power Resources



FIRSTLIGHT HYDRO GENERATING COMPANY  
Northfield Mountain Pumped Storage Project No. 2485  
Turners Falls Hydroelectric Project No. 1889

**STUDY 3.1.2**

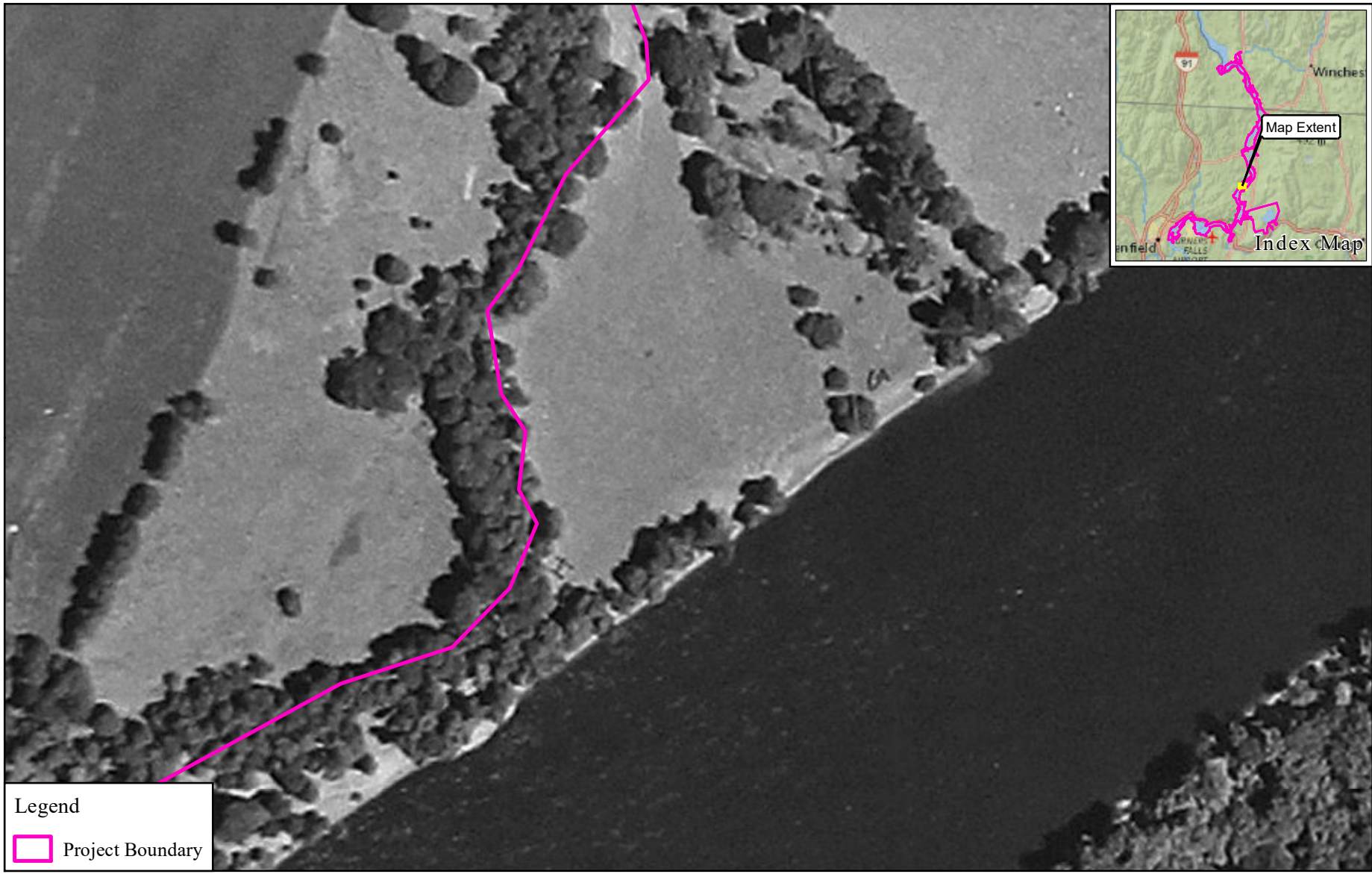


Urgiel  
2014 Imagery  
(Source: NAIP)


Copyright © 2016 FirstLight Power Resources All rights reserved.

## **10 FLAGG - DOWNSTREAM OF OTTER RUN**

The right bank downstream of Otter Run was sparsely vegetated in 1952. By the 1990s photograph no riparian vegetation can be seen on the bank. This reach of the river is in the vicinity of Kidds Island where camping and significant boating activity occurred until recent years. This eroded area was identified in the ECP and is known as the Flagg site. The portion of the Flagg site downstream of Otter Run was restored in 2000 but has been affected by cattle which, while there has been an increase in vegetation and stability, the vegetation is limited by the effect of cattle.



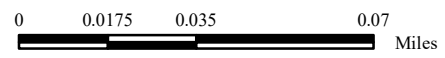
**Legend**

 Project Boundary



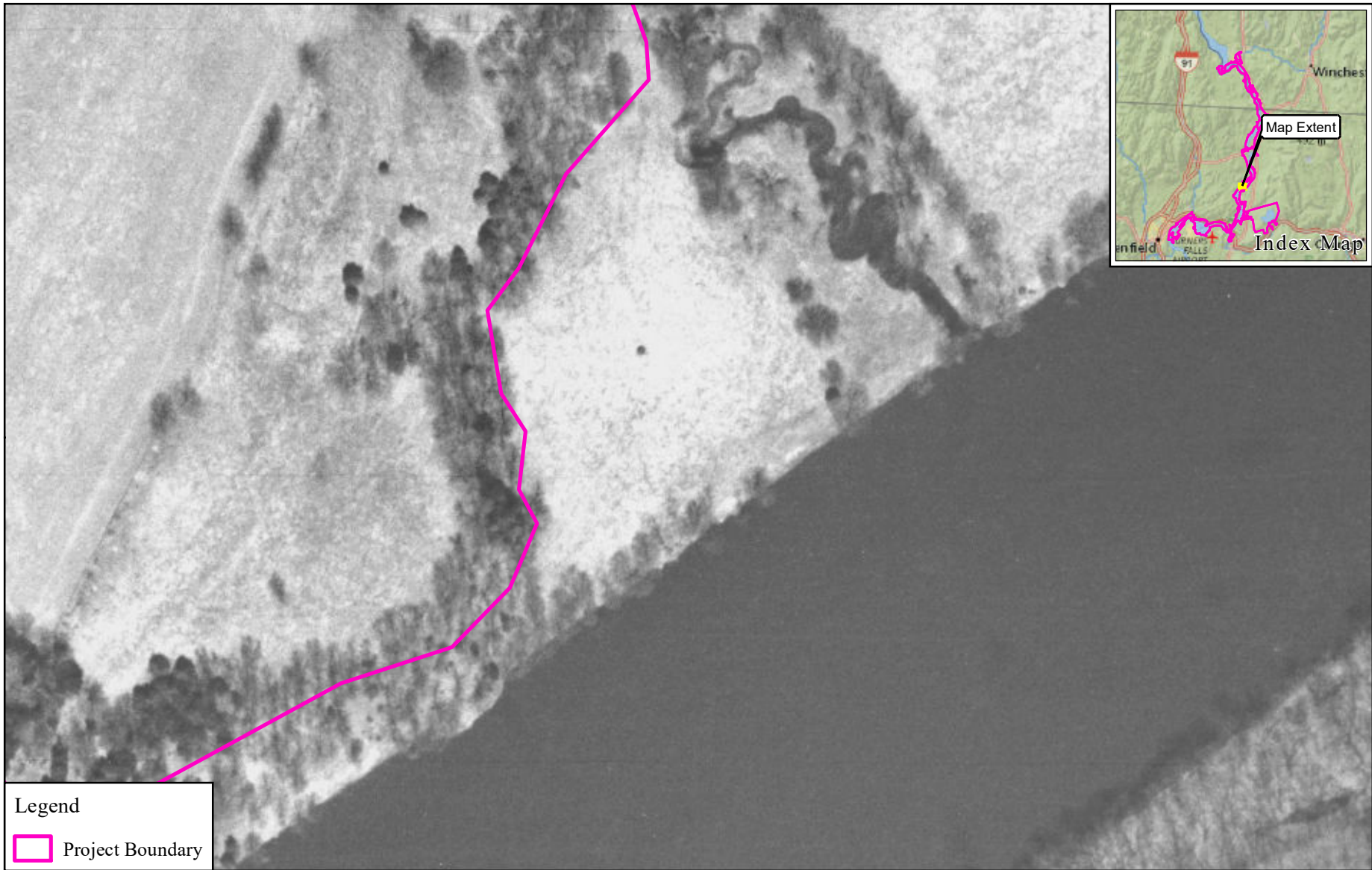
FIRSTLIGHT HYDRO GENERATING COMPANY  
 Northfield Mountain Pumped Storage Project No. 2485  
 Turners Falls Hydroelectric Project No. 1889

STUDY 3.1.2




Flagg (downstream of Otter Run)  
 1952 Imagery  
 (Source: North by Northeast Survey Company)

Copyright © 2016 FirstLight Power Resources All rights reserved.



**Legend**

 Project Boundary

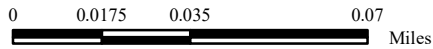


**FirstLight™**  
Power Resources



FIRSTLIGHT HYDRO GENERATING COMPANY  
Northfield Mountain Pumped Storage Project No. 2485  
Turners Falls Hydroelectric Project No. 1889

**STUDY 3.1.2**




Flagg (downstream of Otter Run)  
1960's Imagery  
(Source: USGS)

Copyright © 2016 FirstLight Power Resources All rights reserved.



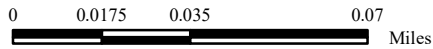
**Legend**

 Project Boundary




FIRSTLIGHT HYDRO GENERATING COMPANY  
 Northfield Mountain Pumped Storage Project No. 2485  
 Turners Falls Hydroelectric Project No. 1889

STUDY 3.1.2



Flagg (downstream of Otter Run)  
 1990's Imagery  
 (Source: MassGIS)

Copyright © 2016 FirstLight Power Resources All rights reserved.



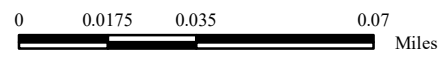
Legend

 Project Boundary




FIRSTLIGHT HYDRO GENERATING COMPANY  
 Northfield Mountain Pumped Storage Project No. 2485  
 Turners Falls Hydroelectric Project No. 1889

STUDY 3.1.2



Flagg (downstream of Otter Run)  
 2008-2010 Imagery  
 (Source: MassGIS)

Copyright © 2016 FirstLight Power Resources All rights reserved.



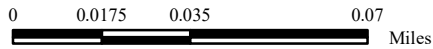
**Legend**

 Project Boundary




FIRSTLIGHT HYDRO GENERATING COMPANY  
 Northfield Mountain Pumped Storage Project No. 2485  
 Turners Falls Hydroelectric Project No. 1889

**STUDY 3.1.2**



Flagg (downstream of Otter Run)  
 2014 Imagery  
 (Source: NAIP)

Copyright © 2016 FirstLight Power Resources All rights reserved.


## **11 FLAGG - UPSTREAM OF OTTER RUN**

The right bank upstream of Otter Run follows the same pattern as the segment downstream from 1952 through the 1990s photographs with sparse riverbank vegetation in the 1950s and 1960s and virtually no riparian vegetation and erosion evident in the 1990s. This upstream site was stabilized in 2000 as part of the Flagg site through the ECP. This segment of the site was fenced off without access to cattle and is now densely vegetated and has a rock toe with aquatic vegetation growing on the lower riverbank. The riparian vegetation can be seen in the recent photographs.





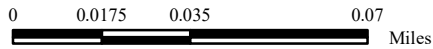
Legend

 Project Boundary



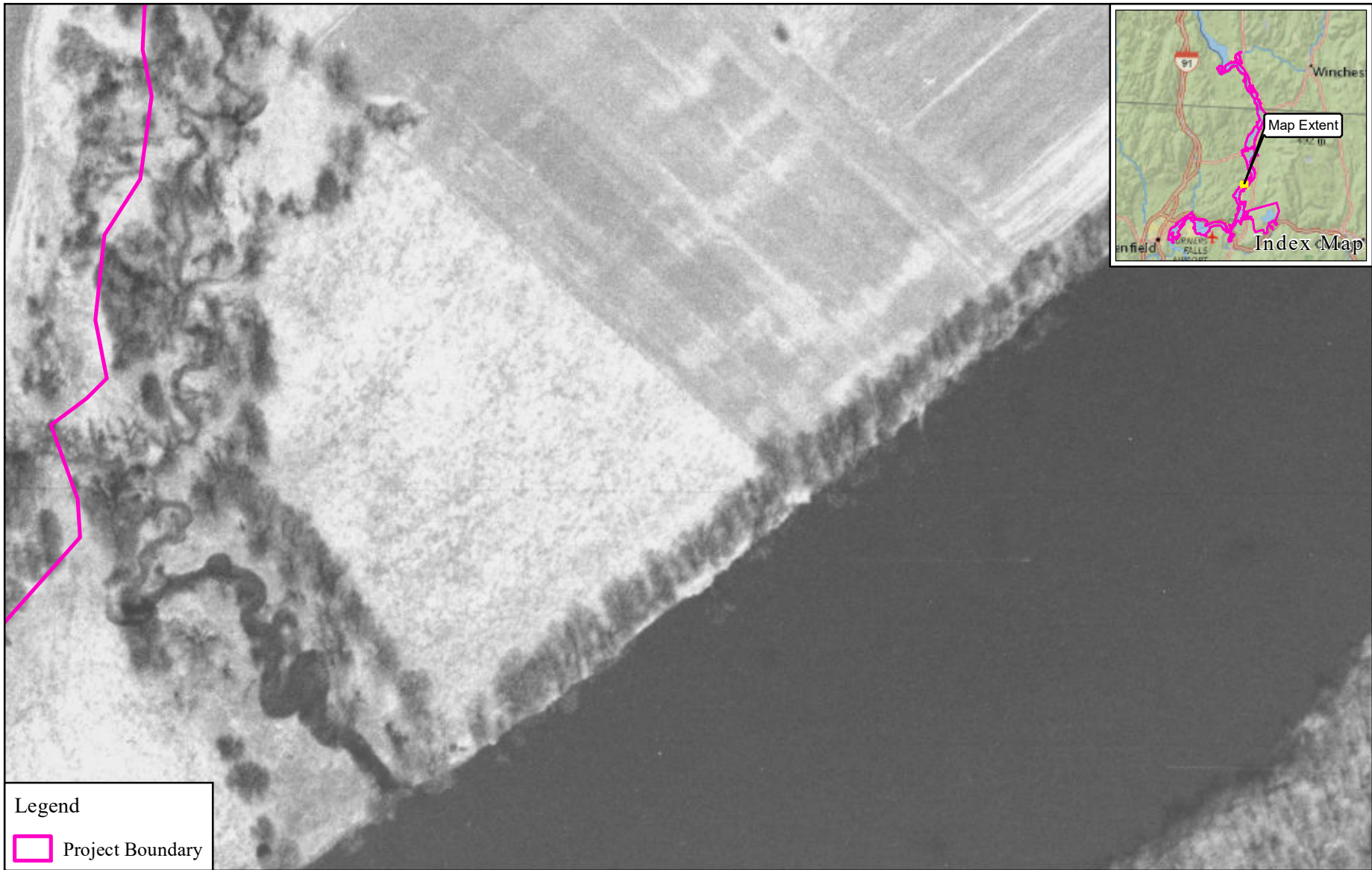

FIRSTLIGHT HYDRO GENERATING COMPANY  
 Northfield Mountain Pumped Storage Project No. 2485  
 Turners Falls Hydroelectric Project No. 1889

STUDY 3.1.2






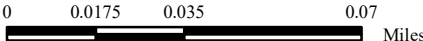
Flagg (upstream of Otter Run)  
 1952 Imagery  
 (Source: North by Northeast Survey Company)

Copyright © 2016 FirstLight Power Resources All rights reserved.




**Legend**


 Project Boundary


	<p>FIRSTLIGHT HYDRO GENERATING COMPANY          Northfield Mountain Pumped Storage Project No. 2485          Turners Falls Hydroelectric Project No. 1889</p> <p><b>STUDY 3.1.2</b></p>	<p>Flagg (upstream of Otter Run)          1960's Imagery          (Source: USGS)</p>
		<p><small>Copyright © 2016 FirstLight Power Resources All rights reserved.</small></p>



Legend

 Project Boundary

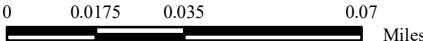




FIRSTLIGHT HYDRO GENERATING COMPANY  
 Northfield Mountain Pumped Storage Project No. 2485  
 Turners Falls Hydroelectric Project No. 1889

STUDY 3.1.2

Flagg (upstream of Otter Run)  
 1990's Imagery  
 (Source: MassGIS)




0 0.0175 0.035 0.07 Miles

Copyright © 2016 FirstLight Power Resources All rights reserved.



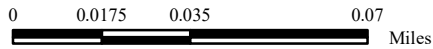
**Legend**

 Project Boundary




FIRSTLIGHT HYDRO GENERATING COMPANY  
 Northfield Mountain Pumped Storage Project No. 2485  
 Turners Falls Hydroelectric Project No. 1889

STUDY 3.1.2




Flagg (upstream of Otter Run)  
 2008-2010 Imagery  
 (Source: MassGIS)

Copyright © 2016 FirstLight Power Resources All rights reserved.



**Legend**

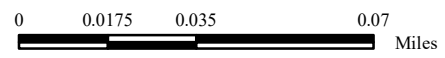
 Project Boundary



**FirstLight™**  
Power Resources



FIRSTLIGHT HYDRO GENERATING COMPANY  
 Northfield Mountain Pumped Storage Project No. 2485  
 Turners Falls Hydroelectric Project No. 1889  
**STUDY 3.1.2**



**Flagg (upstream of Otter Run)**  
 2014 Imagery  
 (Source: NAIP)

Copyright © 2016 FirstLight Power Resources All rights reserved.

## **12 SKALSKI**

The left bank of the river in the vicinity of Kidds Island has a band of riparian vegetation in the 1952, 1960s and 1990s photographs. While not apparent in the photographs, erosion had been occurring along this bank and was identified in the ECP and stabilized in 2004 as the Skalski site as can be seen in the more recent photographs with a rock toe and vegetated upper bank.



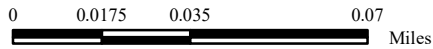
Legend

 Project Boundary



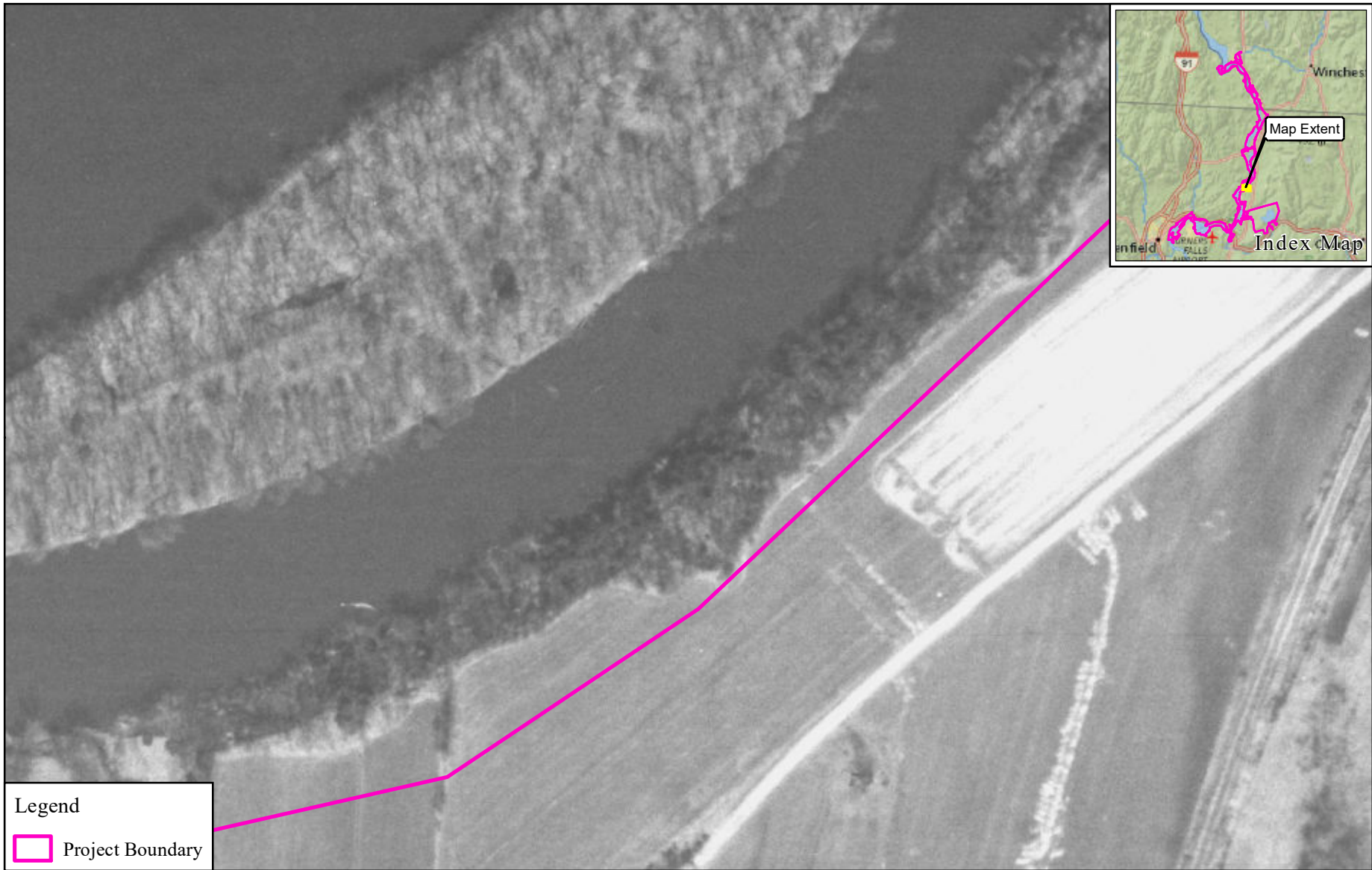

FIRSTLIGHT HYDRO GENERATING COMPANY  
 Northfield Mountain Pumped Storage Project No. 2485  
 Turners Falls Hydroelectric Project No. 1889

STUDY 3.1.2



Skalski  
 1952 Imagery  
 (Source: North by Northeast Survey Company)

Copyright © 2016 FirstLight Power Resources All rights reserved.



**Legend**

 Project Boundary

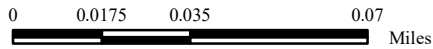


**FirstLight™**  
Power Resources



FIRSTLIGHT HYDRO GENERATING COMPANY  
Northfield Mountain Pumped Storage Project No. 2485  
Turners Falls Hydroelectric Project No. 1889

**STUDY 3.1.2**




Skalski  
1960's Imagery  
(Source: USGS)

Copyright © 2016 FirstLight Power Resources All rights reserved.





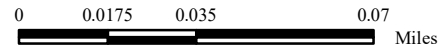
Legend

 Project Boundary




FIRSTLIGHT HYDRO GENERATING COMPANY  
 Northfield Mountain Pumped Storage Project No. 2485  
 Turners Falls Hydroelectric Project No. 1889

STUDY 3.1.2




Skalski  
 1990's Imagery  
 (Source: MassGIS)

Copyright © 2016 FirstLight Power Resources All rights reserved.

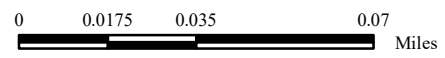


**Legend**

 Project Boundary



FIRSTLIGHT HYDRO GENERATING COMPANY  
 Northfield Mountain Pumped Storage Project No. 2485  
 Turners Falls Hydroelectric Project No. 1889  
**STUDY 3.1.2**




Skalski  
 2008-2010 Imagery  
 (Source: MassGIS)

Copyright © 2016 FirstLight Power Resources All rights reserved.



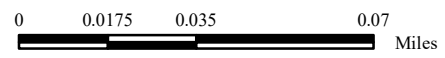
**Legend**

 Project Boundary



FIRSTLIGHT HYDRO GENERATING COMPANY  
 Northfield Mountain Pumped Storage Project No. 2485  
 Turners Falls Hydroelectric Project No. 1889

STUDY 3.1.2

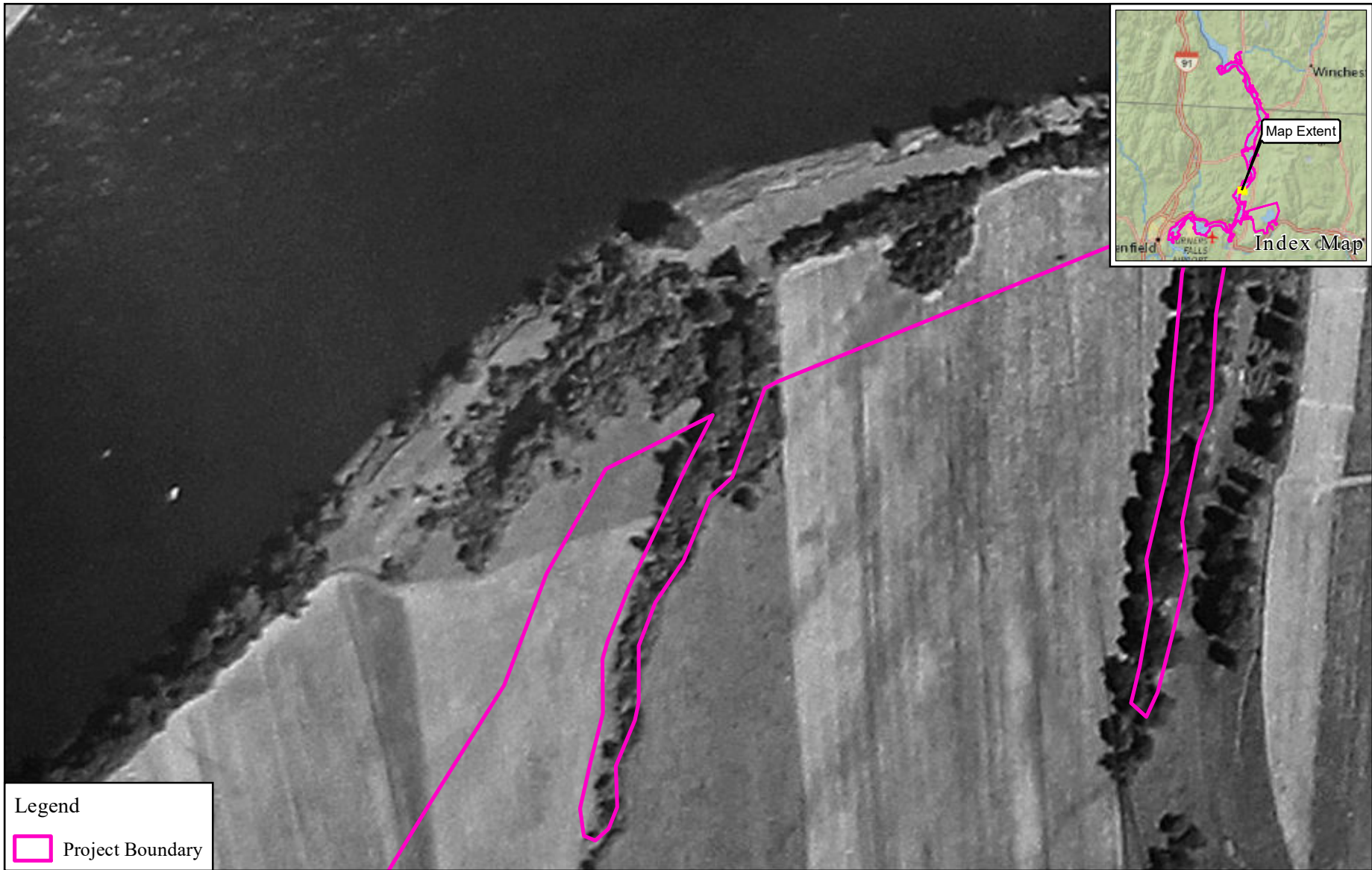


Skalski  
 2014 Imagery  
 (Source: NAIP)


Copyright © 2016 FirstLight Power Resources All rights reserved.

### **13 LEFT BANK DOWNSTREAM OF KIDDS ISLAND**

On the left bank downstream of Kidds Island the 1952 and 1960s photographs show eroded conditions with little riparian vegetation. By the 1990s, the narrow remnants of a field appear to have been eroded away and into another band of riparian vegetation.



**Legend**

 Project Boundary

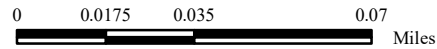


**FirstLight™**  
Power Resources



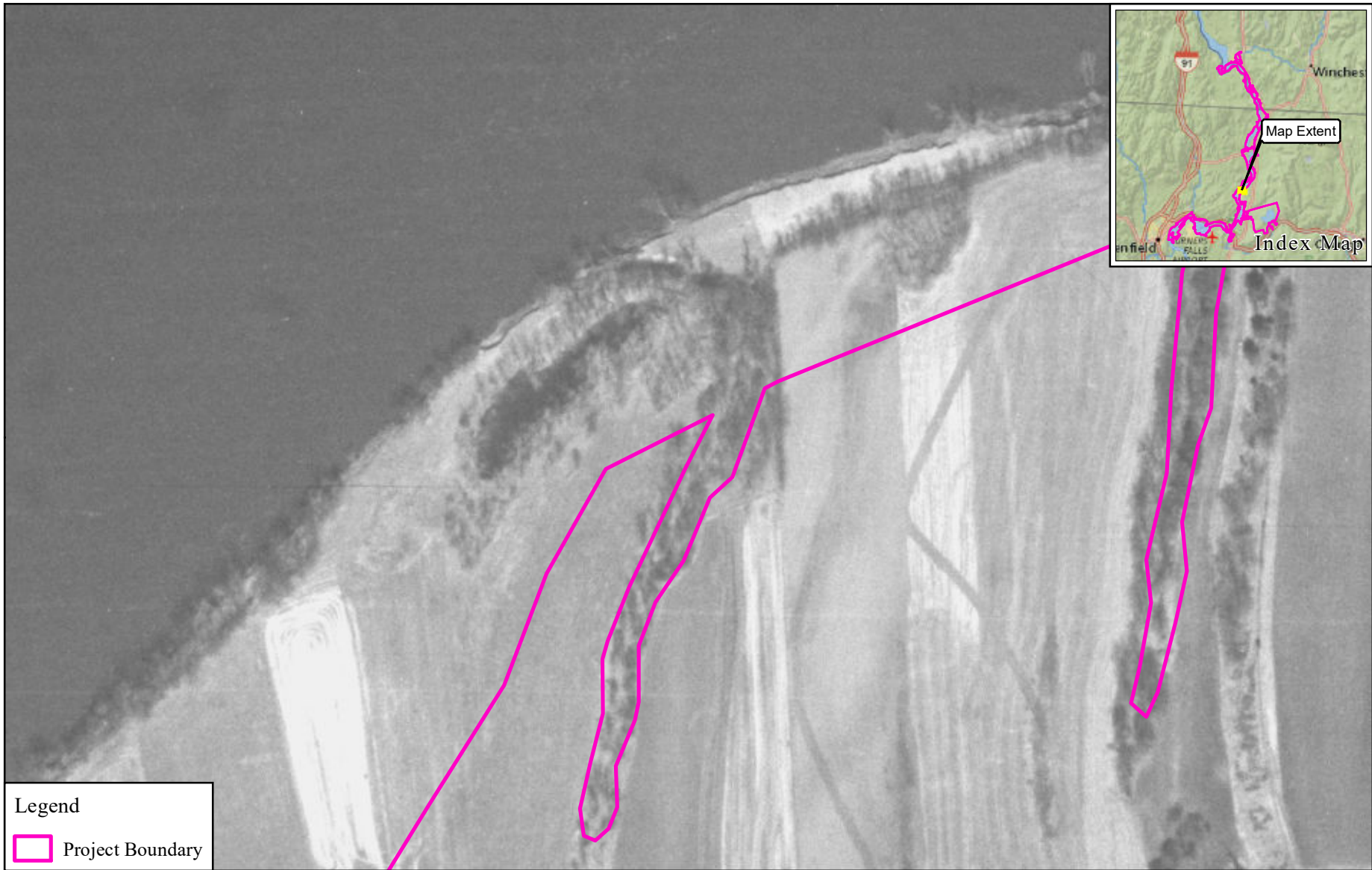
FIRSTLIGHT HYDRO GENERATING COMPANY  
Northfield Mountain Pumped Storage Project No. 2485  
Turners Falls Hydroelectric Project No. 1889

**STUDY 3.1.2**



Left Bank Downstream of Kidds Island  
1952 Imagery  
(Source: North by Northeast Survey Company)

Copyright © 2016 FirstLight Power Resources All rights reserved.



**Legend**

 Project Boundary

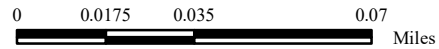


**FirstLight™**  
Power Resources



FIRSTLIGHT HYDRO GENERATING COMPANY  
Northfield Mountain Pumped Storage Project No. 2485  
Turners Falls Hydroelectric Project No. 1889

STUDY 3.1.2




Left Bank Downstream of Kidds Island  
1960's Imagery  
(Source: USGS)

Copyright © 2016 FirstLight Power Resources All rights reserved.



**Legend**

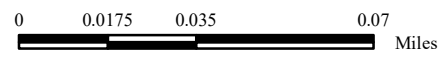
 Project Boundary



**FirstLight**  
Power Resources



FIRSTLIGHT HYDRO GENERATING COMPANY  
 Northfield Mountain Pumped Storage Project No. 2485  
 Turners Falls Hydroelectric Project No. 1889  
**STUDY 3.1.2**



**Left Bank Downstream of Kidds Island**  
 1990's Imagery  
 (Source: MassGIS)

Copyright © 2016 FirstLight Power Resources All rights reserved.



**Legend**

 Project Boundary

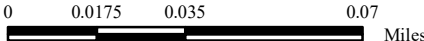


**FirstLight™**  
Power Resources



FIRSTLIGHT HYDRO GENERATING COMPANY  
 Northfield Mountain Pumped Storage Project No. 2485  
 Turners Falls Hydroelectric Project No. 1889

STUDY 3.1.2




Left Bank Downstream of Kidds Island  
 2008-2010 Imagery  
 (Source: MassGIS)

Copyright © 2016 FirstLight Power Resources All rights reserved.





**Legend**

 Project Boundary

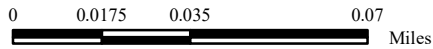


**FirstLight**<sup>™</sup>  
Power Resources



FIRSTLIGHT HYDRO GENERATING COMPANY  
 Northfield Mountain Pumped Storage Project No. 2485  
 Turners Falls Hydroelectric Project No. 1889

STUDY 3.1.2

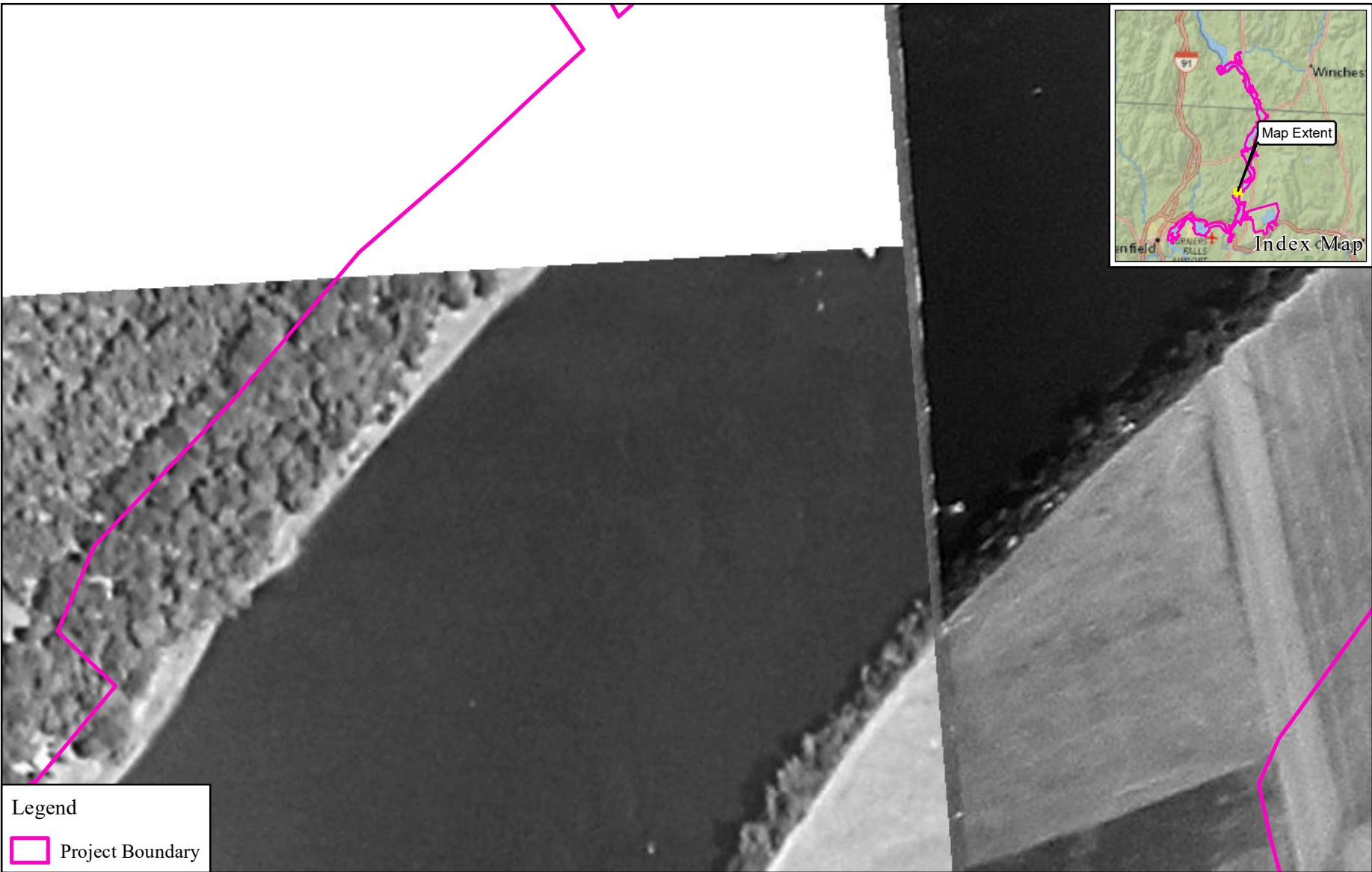


Left Bank Downstream of Kidds Island  
 2014 Imagery  
 (Source: NAIP)

Copyright © 2016 FirstLight Power Resources All rights reserved.

## **14 L'ETOILE**

Another few thousand feet downstream of Kidds Island on the left bank is another area adjacent to an agricultural field with a very narrow band of riparian vegetation which appears to have narrowed over time from 1952 to the 1990s. In 1998 stabilization occurred at what was called the L'Etoile site which can be seen in subsequent photographs.



Legend

 Project Boundary

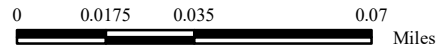


**FirstLight**<sup>™</sup>  
Power Resources



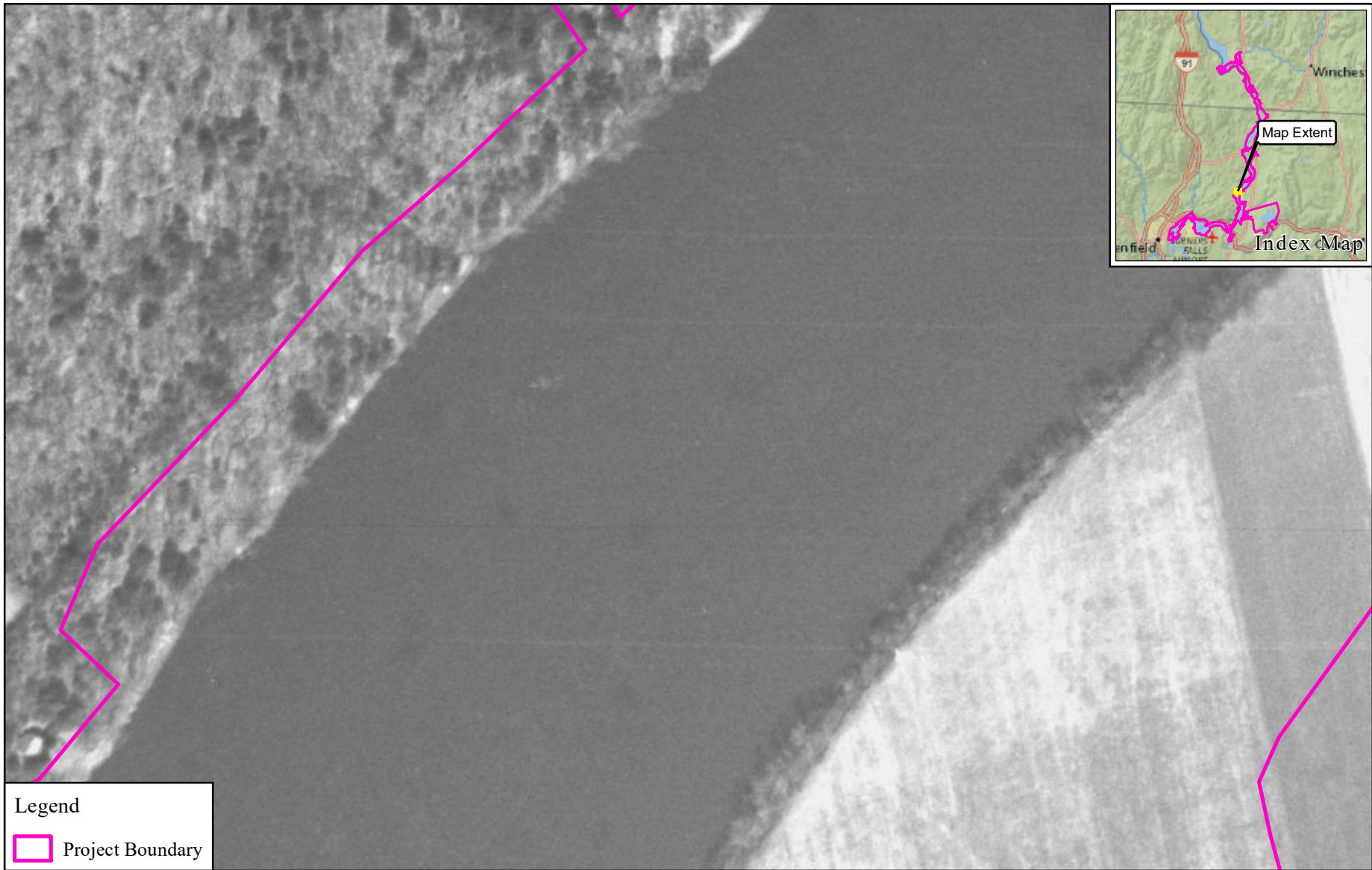
FIRSTLIGHT HYDRO GENERATING COMPANY  
Northfield Mountain Pumped Storage Project No. 2485  
Turners Falls Hydroelectric Project No. 1889

STUDY 3.1.2






L'Etoile  
1952 Imagery  
(Source: North by Northeast Survey Company)

Copyright © 2016 FirstLight Power Resources All rights reserved.



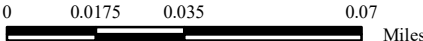
Legend

 Project Boundary

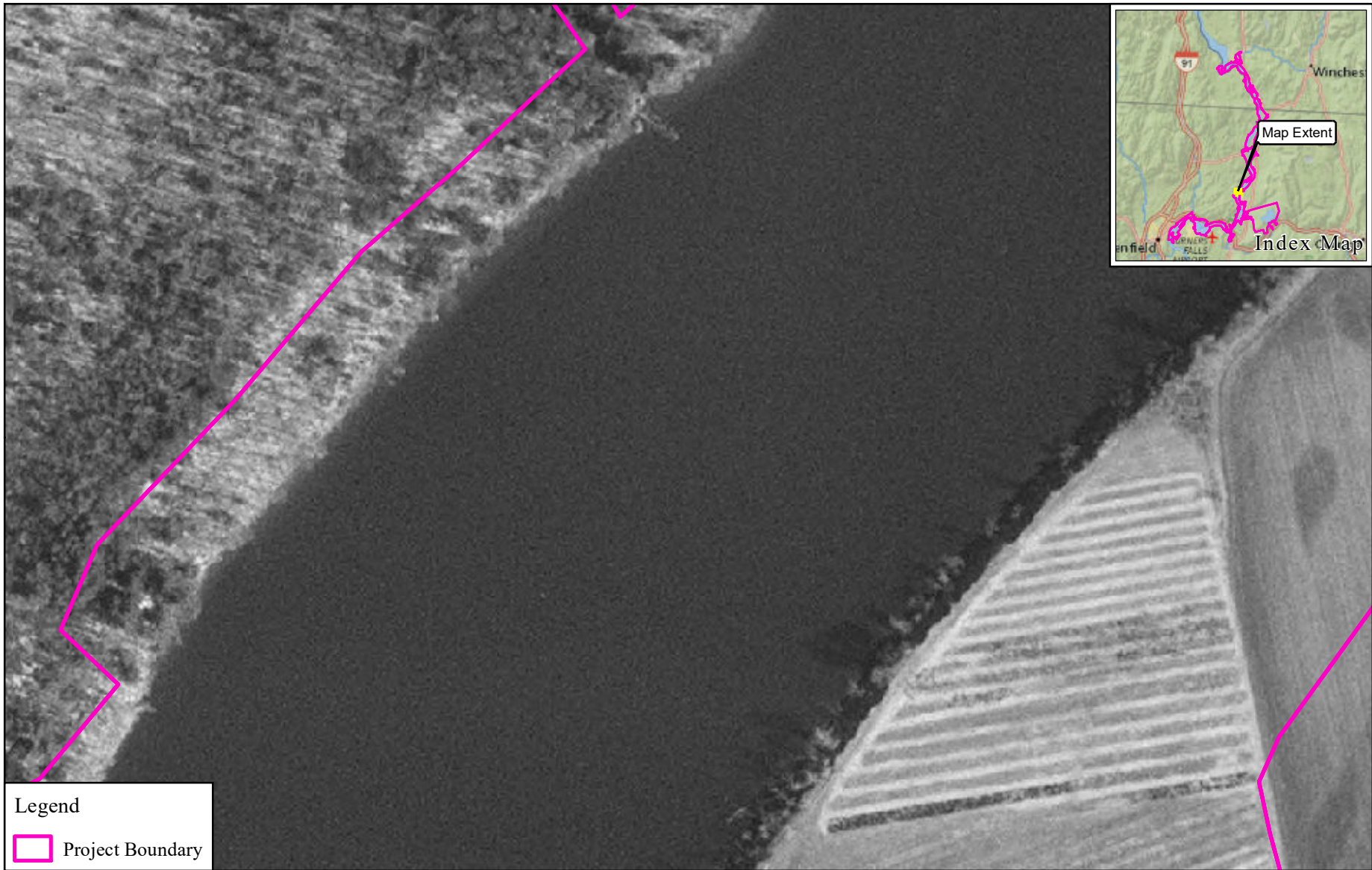
FIRSTLIGHT HYDRO GENERATING COMPANY  
Northfield Mountain Pumped Storage Project No. 2485  
Turners Falls Hydroelectric Project No. 1889

STUDY 3.1.2


 Miles

L'Etoile  
1960's Imagery  
(Source: USGS)

Copyright © 2016 FirstLight Power Resources All rights reserved.



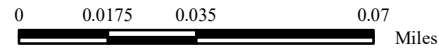
Legend

 Project Boundary




FIRSTLIGHT HYDRO GENERATING COMPANY  
 Northfield Mountain Pumped Storage Project No. 2485  
 Turners Falls Hydroelectric Project No. 1889

STUDY 3.1.2



L'Etoile  
 1990's Imagery  
 (Source: MassGIS)

Copyright © 2016 FirstLight Power Resources All rights reserved.



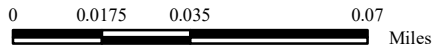
Legend

 Project Boundary




FIRSTLIGHT HYDRO GENERATING COMPANY  
 Northfield Mountain Pumped Storage Project No. 2485  
 Turners Falls Hydroelectric Project No. 1889

STUDY 3.1.2



L'Etoile  
 2008-2010 Imagery  
 (Source: MassGIS)

Copyright © 2016 FirstLight Power Resources All rights reserved.



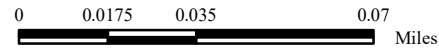
**Legend**

 Project Boundary




FIRSTLIGHT HYDRO GENERATING COMPANY  
 Northfield Mountain Pumped Storage Project No. 2485  
 Turners Falls Hydroelectric Project No. 1889

**STUDY 3.1.2**



L'Etoile  
 2014 Imagery  
 (Source: NAIP)

Copyright © 2016 FirstLight Power Resources All rights reserved.


## **15 SHEARER/BATHORY-GALLAGHER**

Upstream of the tailrace along both banks there was a band of riparian vegetation in the 1952 photograph. By the 1960s photograph the riparian zone appear to have decreased and erosion is evident. The left bank was stabilized in 1996 (Shearer site) and the right bank was stabilized through the ECP as the Bathory/Gallagher site in 2012 as can be seen on recent photographs.





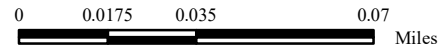
Legend

 Project Boundary



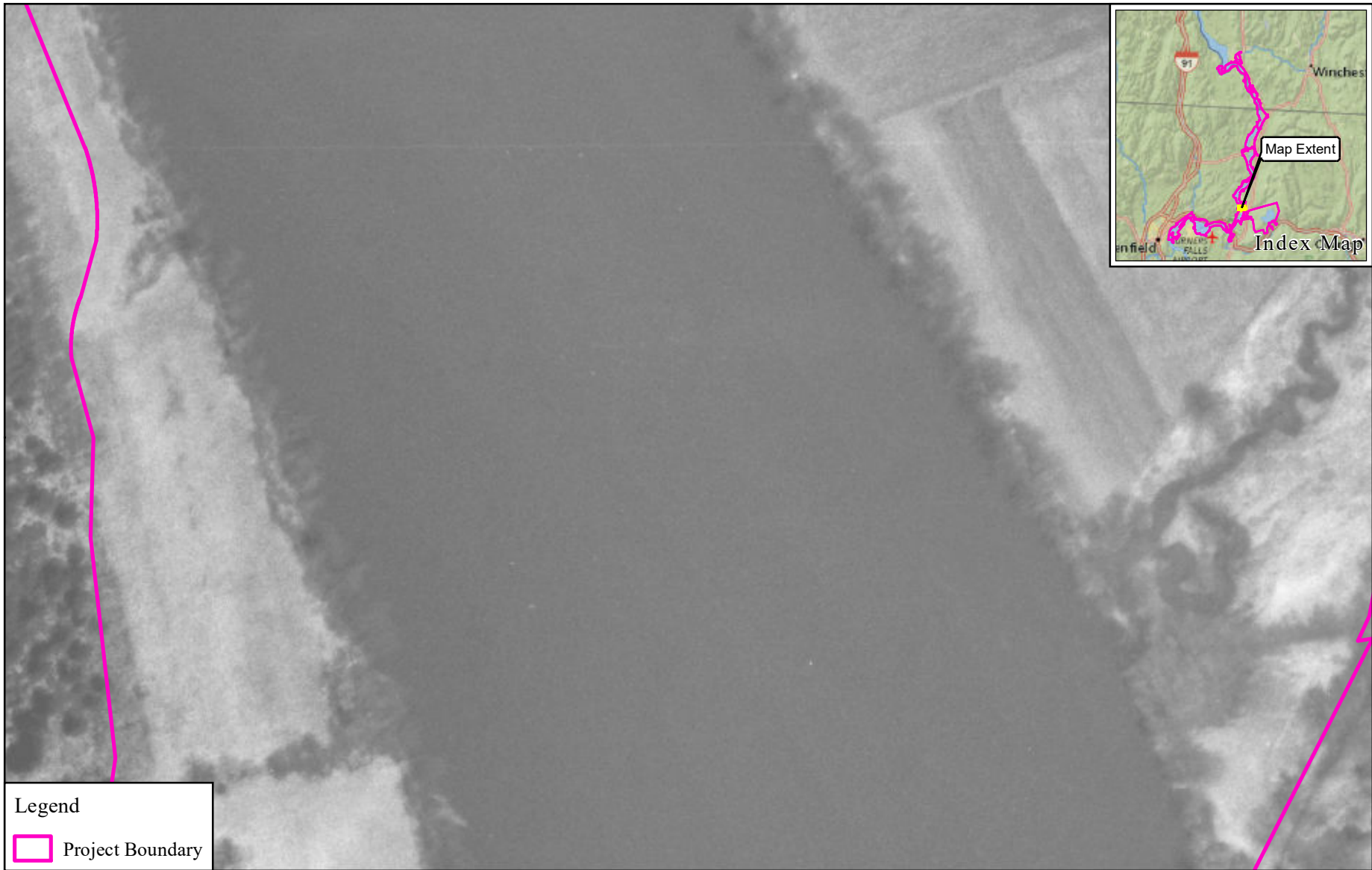

FIRSTLIGHT HYDRO GENERATING COMPANY  
 Northfield Mountain Pumped Storage Project No. 2485  
 Turners Falls Hydroelectric Project No. 1889

STUDY 3.1.2




Shearer/Bathory-Gallagher  
 1952 Imagery  
 (Source: North by Northeast Survey Company)

Copyright © 2016 FirstLight Power Resources All rights reserved.



**Legend**

 Project Boundary

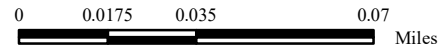


**FirstLight**<sup>™</sup>  
Power Resources



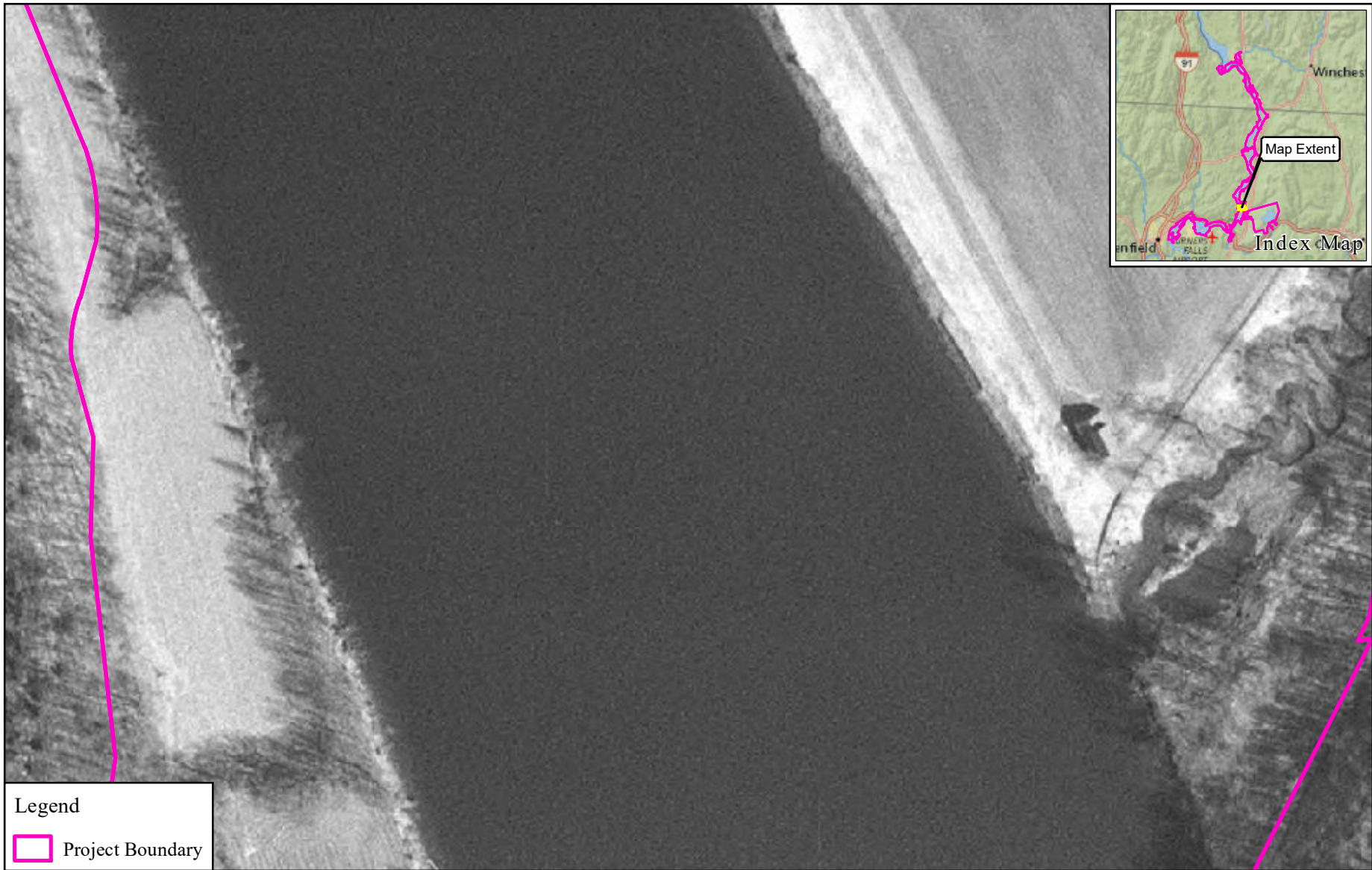
FIRSTLIGHT HYDRO GENERATING COMPANY  
Northfield Mountain Pumped Storage Project No. 2485  
Turners Falls Hydroelectric Project No. 1889

**STUDY 3.1.2**




Shearer/Bathory-Gallagher  
1960's Imagery  
(Source: USGS)

Copyright © 2016 FirstLight Power Resources All rights reserved.



**Legend**

 Project Boundary

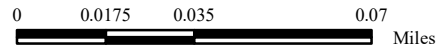


**FirstLight**<sup>™</sup>  
Power Resources



FIRSTLIGHT HYDRO GENERATING COMPANY  
Northfield Mountain Pumped Storage Project No. 2485  
Turners Falls Hydroelectric Project No. 1889

STUDY 3.1.2




Shearer/Bathory-Gallagher  
1990's Imagery  
(Source: MassGIS)

Copyright © 2016 FirstLight Power Resources All rights reserved.



**Legend**

 Project Boundary

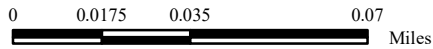


**FirstLight™**  
Power Resources



FIRSTLIGHT HYDRO GENERATING COMPANY  
Northfield Mountain Pumped Storage Project No. 2485  
Turners Falls Hydroelectric Project No. 1889

STUDY 3.1.2




Shearer/Bathory-Gallagher  
2008-2010 Imagery  
(Source: MassGIS)

Copyright © 2016 FirstLight Power Resources All rights reserved.



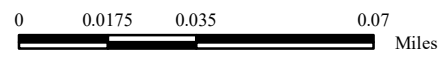
**Legend**

 Project Boundary




FIRSTLIGHT HYDRO GENERATING COMPANY  
 Northfield Mountain Pumped Storage Project No. 2485  
 Turners Falls Hydroelectric Project No. 1889

**STUDY 3.1.2**

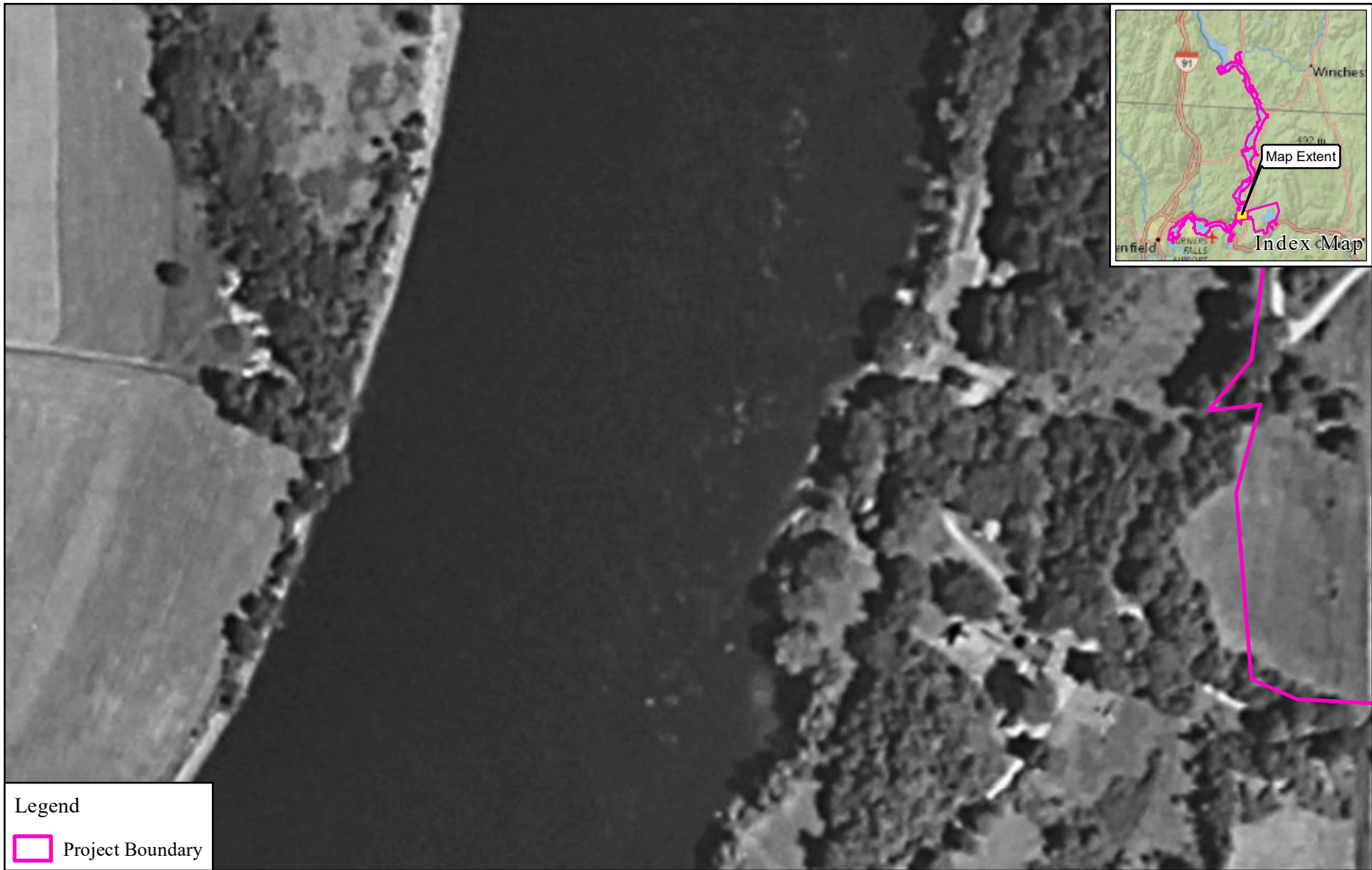


Shearer/Bathory-Gallagher  
 2014 Imagery  
 (Source: NAIP)

Copyright © 2016 FirstLight Power Resources All rights reserved.

## **16 UPPER SPLIT RIVER**

The right bank of the river in this location is eroded and has little riparian vegetation in the 1952 and 1960s photographs. The lower part of the photograph of the right bank was stabilized using rock (see discussion of tailrace in next segment) while the upper part of the photograph of the right bank was selected as the Upper Split River site and was stabilized in 2010 using a gravel beach and large woody debris as can be seen on the 2014 photograph.



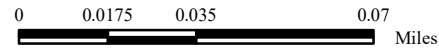
Legend

 Project Boundary




FIRSTLIGHT HYDRO GENERATING COMPANY  
 Northfield Mountain Pumped Storage Project No. 2485  
 Turners Falls Hydroelectric Project No. 1889

STUDY 3.1.2



Upper Split River  
 1952 Imagery  
 (Source: North by Northeast Survey Company)

Copyright © 2016 FirstLight Power Resources All rights reserved.



Legend

 Project Boundary

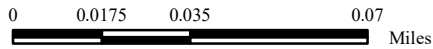


**FirstLight**<sup>™</sup>  
Power Resources



FIRSTLIGHT HYDRO GENERATING COMPANY  
Northfield Mountain Pumped Storage Project No. 2485  
Turners Falls Hydroelectric Project No. 1889

STUDY 3.1.2




Upper Split River  
1960's Imagery  
(Source: USGS)

Copyright © 2016 FirstLight Power Resources All rights reserved.





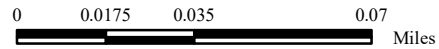
Legend

 Project Boundary




FIRSTLIGHT HYDRO GENERATING COMPANY  
 Northfield Mountain Pumped Storage Project No. 2485  
 Turners Falls Hydroelectric Project No. 1889

STUDY 3.1.2





Upper Split River  
 1990's Imagery  
 (Source: MassGIS)

Copyright © 2016 FirstLight Power Resources All rights reserved.




Legend

 Project Boundary



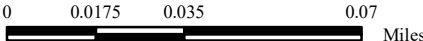
**FirstLight**<sup>™</sup>  
Power Resources



N

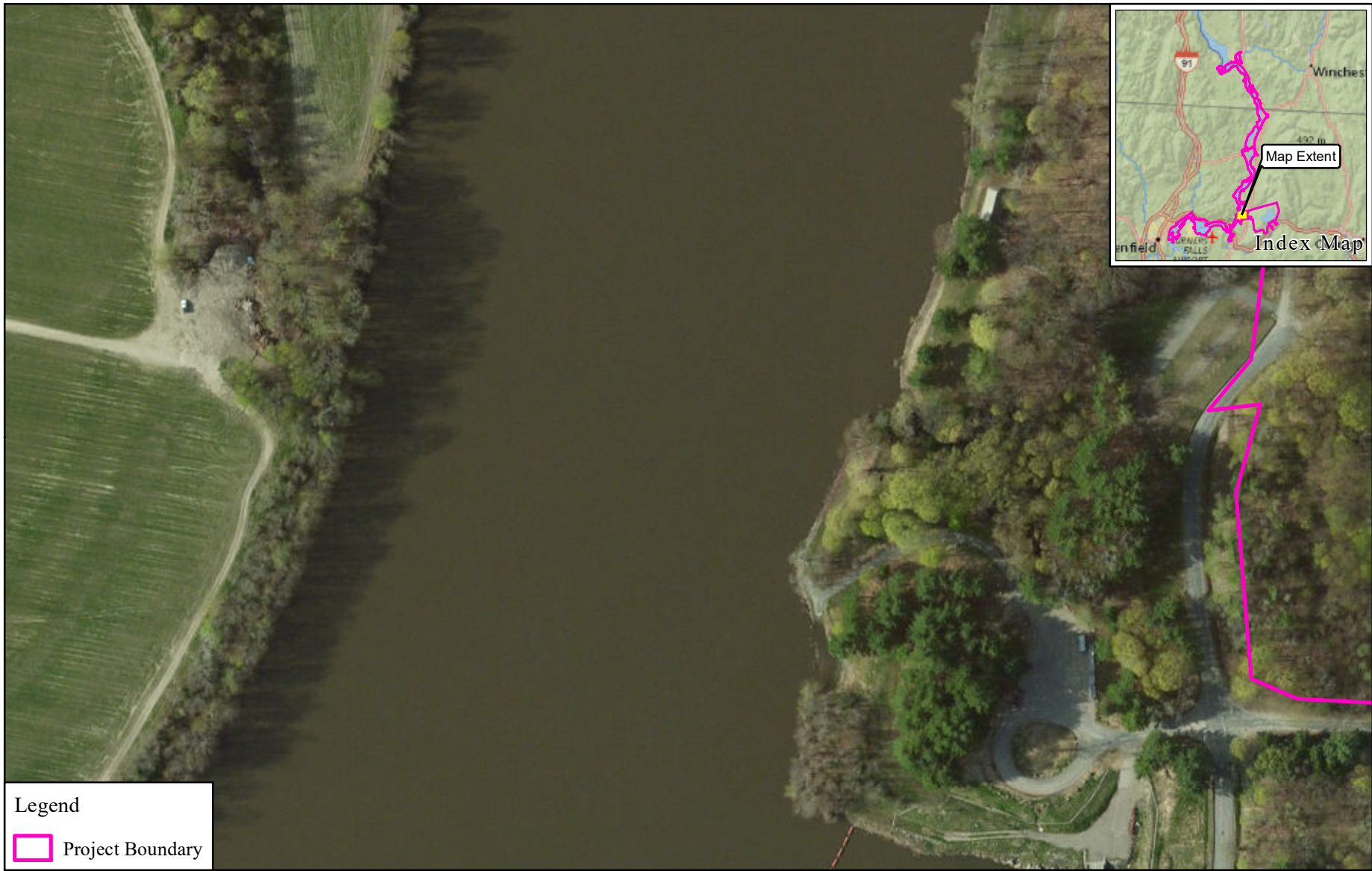
FIRSTLIGHT HYDRO GENERATING COMPANY  
Northfield Mountain Pumped Storage Project No. 2485  
Turners Falls Hydroelectric Project No. 1889  
**STUDY 3.1.2**

Upper Split River  
2008-2010 Imagery  
(Source: MassGIS)




0 0.0175 0.035 0.07 Miles

Copyright © 2016 FirstLight Power Resources All rights reserved.



**Legend**

 Project Boundary

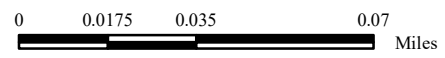


**FirstLight**<sup>™</sup>  
Power Resources



FIRSTLIGHT HYDRO GENERATING COMPANY  
 Northfield Mountain Pumped Storage Project No. 2485  
 Turners Falls Hydroelectric Project No. 1889

**STUDY 3.1.2**

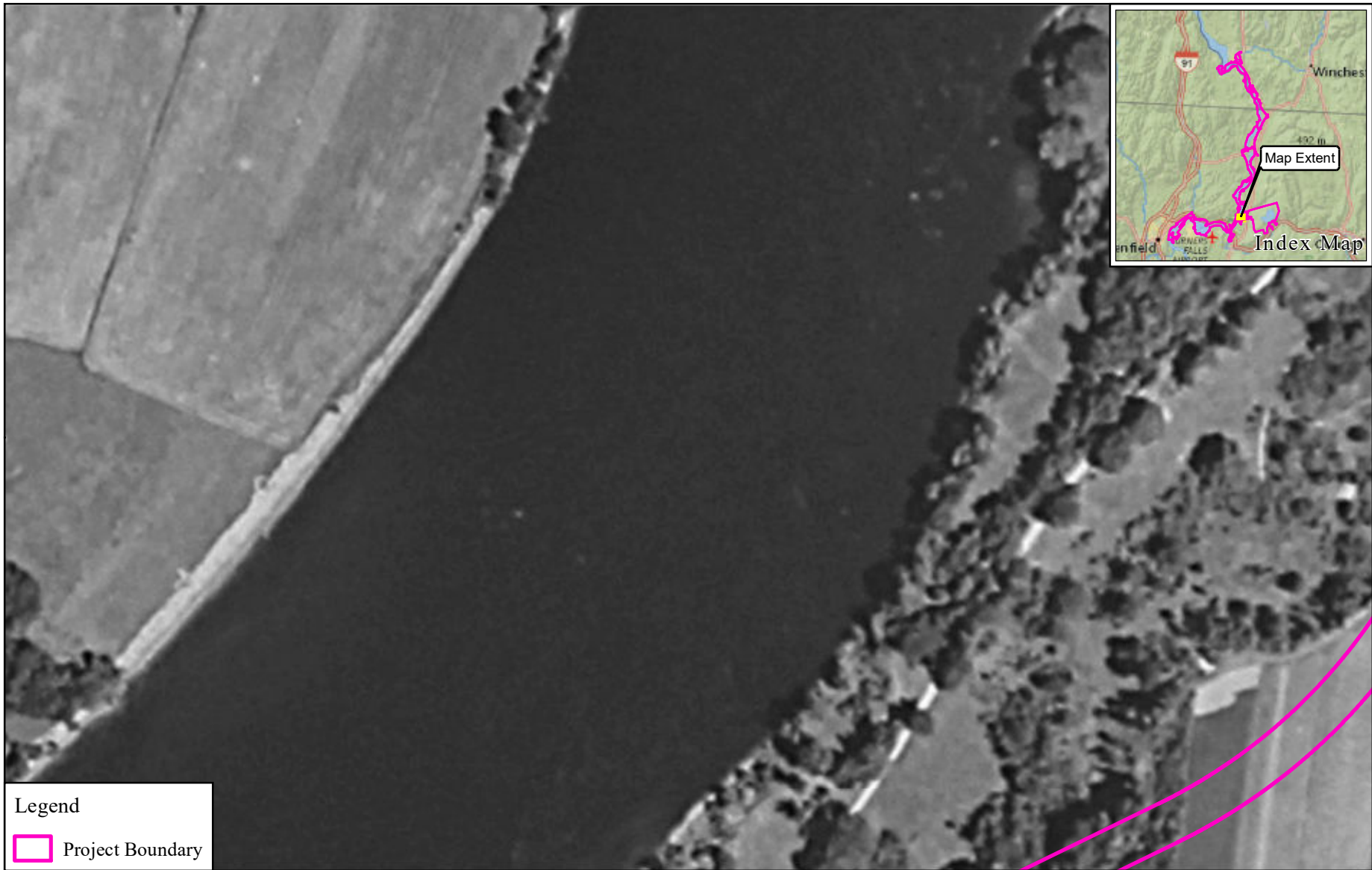


Upper Split River  
 2014 Imagery  
 (Source: NAIP)


Copyright © 2016 FirstLight Power Resources All rights reserved.

## **17 NORTHFIELD MOUNTAIN TAILRACE**

The right bank across the river from the future tailrace for Northfield Mountain appears to be eroded and devoid of riparian vegetation in the 1952 and 1960s photographs, before the construction of the project. Rock from project construction was used to stabilize this eroded bank during the construction process. The rock has stabilized the toe of the bank and riparian vegetation has become established above the rock.



Legend

 Project Boundary

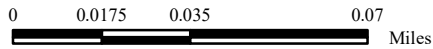


**FirstLight**<sup>™</sup>  
Power Resources



FIRSTLIGHT HYDRO GENERATING COMPANY  
 Northfield Mountain Pumped Storage Project No. 2485  
 Turners Falls Hydroelectric Project No. 1889

STUDY 3.1.2



Northfield Mountain Tailrace  
 1952 Imagery  
 (Source: North by Northeast Survey Company)

Copyright © 2016 FirstLight Power Resources All rights reserved.



Legend

 Project Boundary

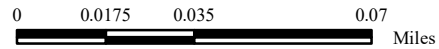


**FirstLight**<sup>™</sup>  
Power Resources



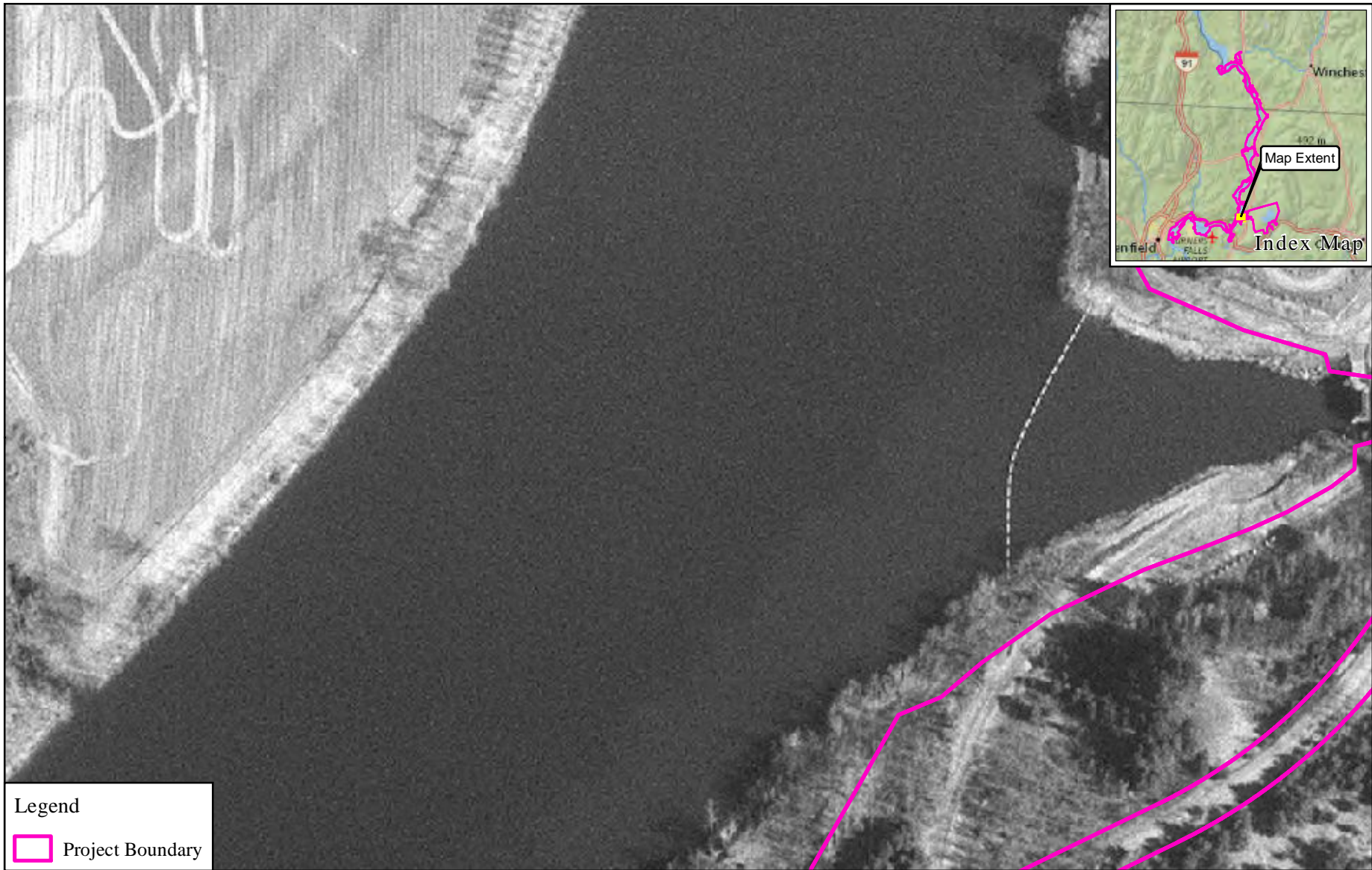
FIRSTLIGHT HYDRO GENERATING COMPANY  
Northfield Mountain Pumped Storage Project No. 2485  
Turners Falls Hydroelectric Project No. 1889

STUDY 3.1.2



Northfield Mountain Tailrace  
1960's Imagery  
(Source: USGS)

Copyright © 2016 FirstLight Power Resources All rights reserved.



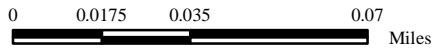
Legend

 Project Boundary




FIRSTLIGHT HYDRO GENERATING COMPANY  
 Northfield Mountain Pumped Storage Project No. 2485  
 Turners Falls Hydroelectric Project No. 1889

STUDY 3.1.2



Northfield Mountain Tailrace  
 1990's Imagery  
 (Source: MassGIS)

Copyright © 2016 FirstLight Power Resources All rights reserved.



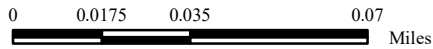
Legend

 Project Boundary




FIRSTLIGHT HYDRO GENERATING COMPANY  
 Northfield Mountain Pumped Storage Project No. 2485  
 Turners Falls Hydroelectric Project No. 1889

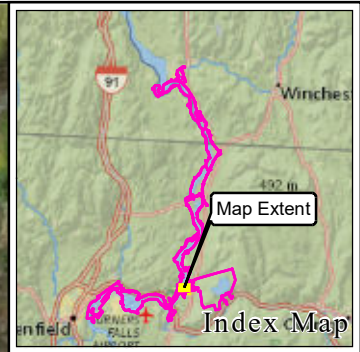
STUDY 3.1.2




Northfield Mountain Tailrace  
 2008-2010 Imagery  
 (Source: MassGIS)

Copyright © 2016 FirstLight Power Resources All rights reserved.





Legend

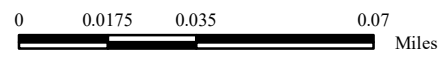
 Project Boundary



**FirstLight**<sup>™</sup>  
Power Resources



FIRSTLIGHT HYDRO GENERATING COMPANY  
Northfield Mountain Pumped Storage Project No. 2485  
Turners Falls Hydroelectric Project No. 1889  
**STUDY 3.1.2**

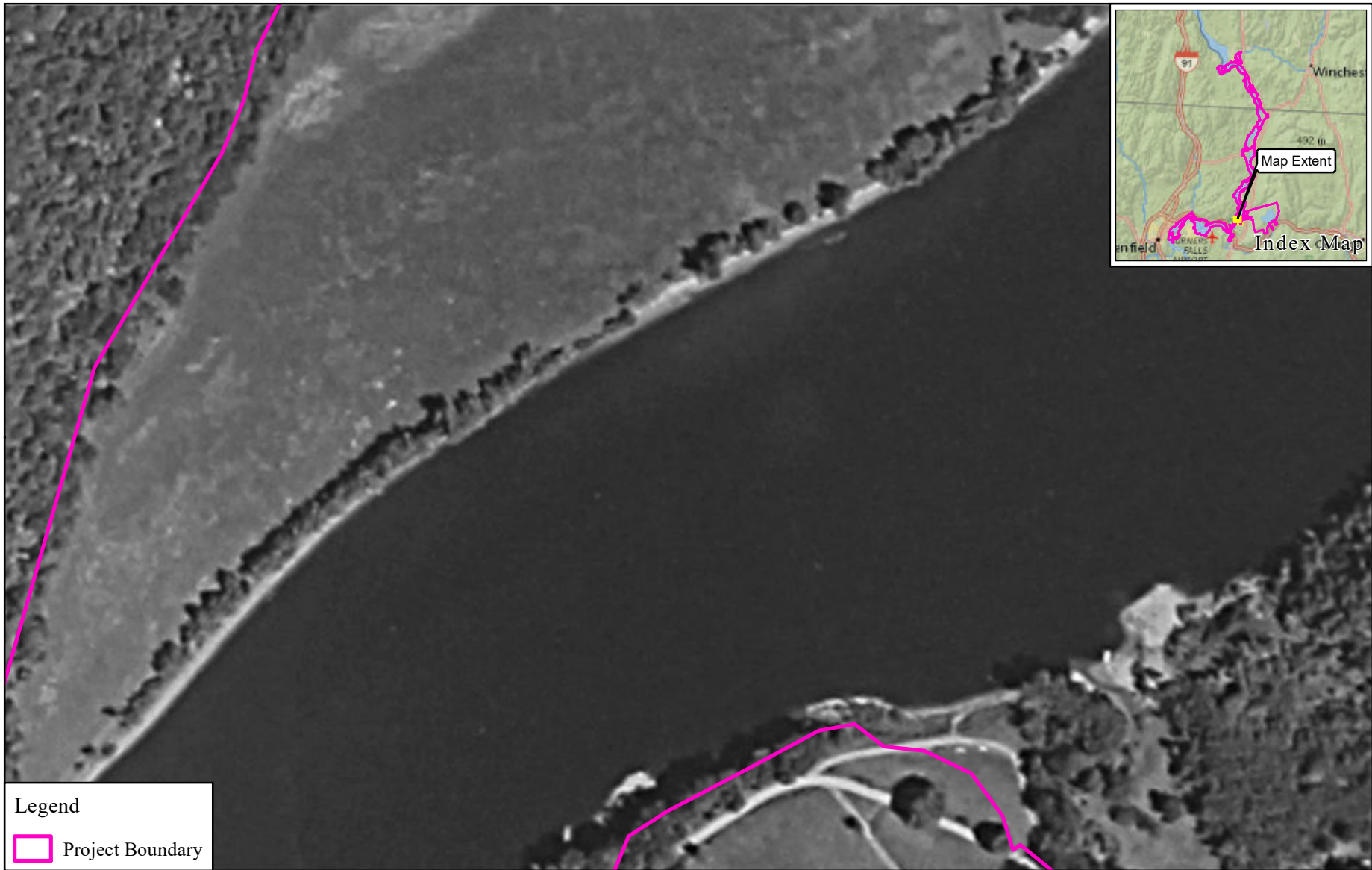


Northfield Mountain Tailrace  
2014 Imagery  
(Source: NAIP)


Copyright © 2016 FirstLight Power Resources All rights reserved.

## **18 LOWER SPLIT RIVER/DURKEE POINT**

The right bank in the 1952 photograph is sparsely vegetated with apparent erosion as is a segment of the left bank. By the 1960s photographs erosion of the left bank segment is apparent while the right bank remains sparsely vegetated with some erosion. The right bank sight is called the Lower Split River site which was stabilized in 2009 and the left bank segment is called Durkee Point and was stabilized in 2003, both through implementation of the ECP.



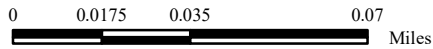
Legend

 Project Boundary



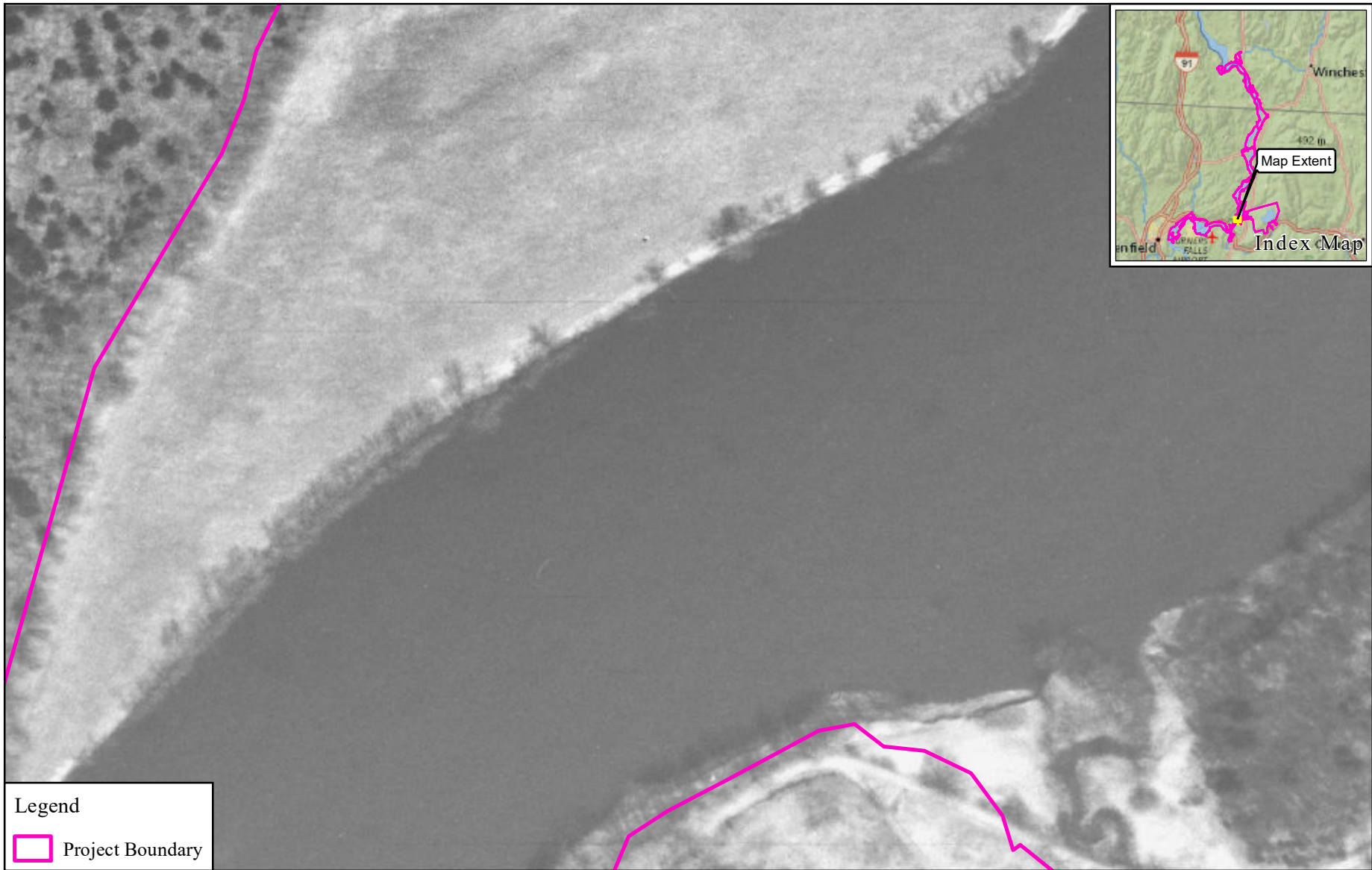

FIRSTLIGHT HYDRO GENERATING COMPANY  
 Northfield Mountain Pumped Storage Project No. 2485  
 Turners Falls Hydroelectric Project No. 1889

STUDY 3.1.2







Lower Split River  
 1952 Imagery  
 (Source: North by Northeast Survey Company)

Copyright © 2016 FirstLight Power Resources All rights reserved.




Legend

 Project Boundary

	<p>FIRSTLIGHT HYDRO GENERATING COMPANY          Northfield Mountain Pumped Storage Project No. 2485          Turners Falls Hydroelectric Project No. 1889</p> <p>STUDY 3.1.2</p> <p>0    0.0175    0.035    0.07   Miles</p>	<p>Lower Split River          1960's Imagery          (Source: USGS)</p>
		
Copyright © 2016 FirstLight Power Resources All rights reserved.		



**Legend**

 Project Boundary

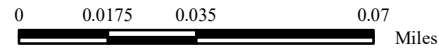


**FirstLight™**  
Power Resources



FIRSTLIGHT HYDRO GENERATING COMPANY  
Northfield Mountain Pumped Storage Project No. 2485  
Turners Falls Hydroelectric Project No. 1889

**STUDY 3.1.2**



Lower Split River  
1990's Imagery  
(Source: MassGIS)

Copyright © 2016 FirstLight Power Resources All rights reserved.



**Legend**

 Project Boundary

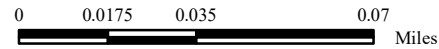


**FirstLight™**  
Power Resources



FIRSTLIGHT HYDRO GENERATING COMPANY  
Northfield Mountain Pumped Storage Project No. 2485  
Turners Falls Hydroelectric Project No. 1889

**STUDY 3.1.2**



**Lower Split River**  
2008-2010 Imagery  
(Source: MassGIS)

Copyright © 2016 FirstLight Power Resources All rights reserved.



**Legend**

 Project Boundary

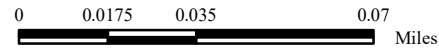


**FirstLight™**  
Power Resources



FIRSTLIGHT HYDRO GENERATING COMPANY  
Northfield Mountain Pumped Storage Project No. 2485  
Turners Falls Hydroelectric Project No. 1889

**STUDY 3.1.2**



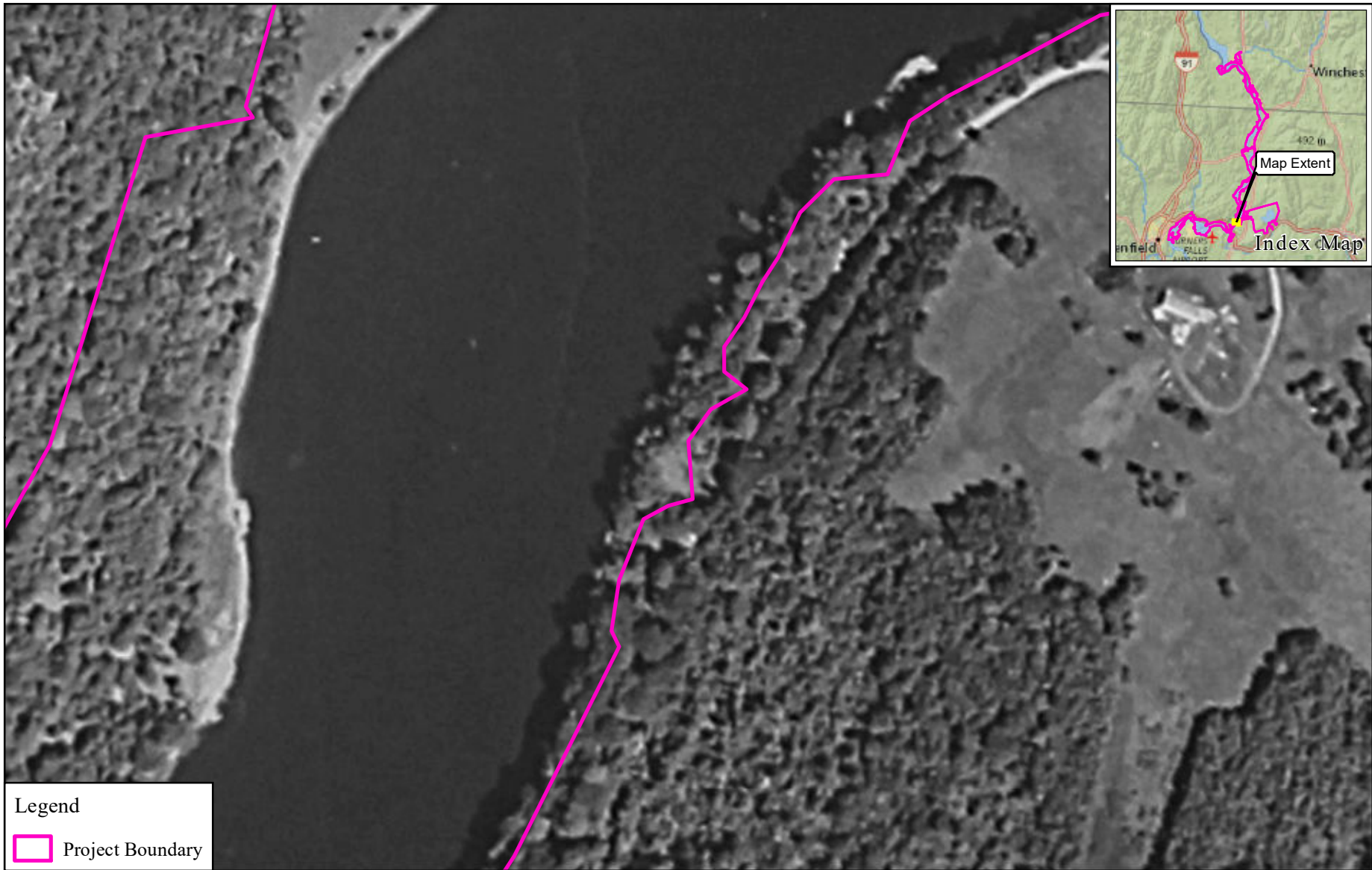
**Lower Split River**  
2014 Imagery  
(Source: NAIP)

Copyright © 2016 FirstLight Power Resources All rights reserved.


## **19 RIVER ROAD**

On the inside of the bend along the left bank erosion has occurred over time with the bank moving landward compared to the project boundary line as noted in changes in the bank from the 1952 to 1960s and subsequent photographs. This area was stabilized in 2003 through the ECP and is called the River Road Site.





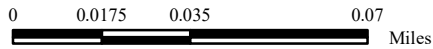
Legend

 Project Boundary



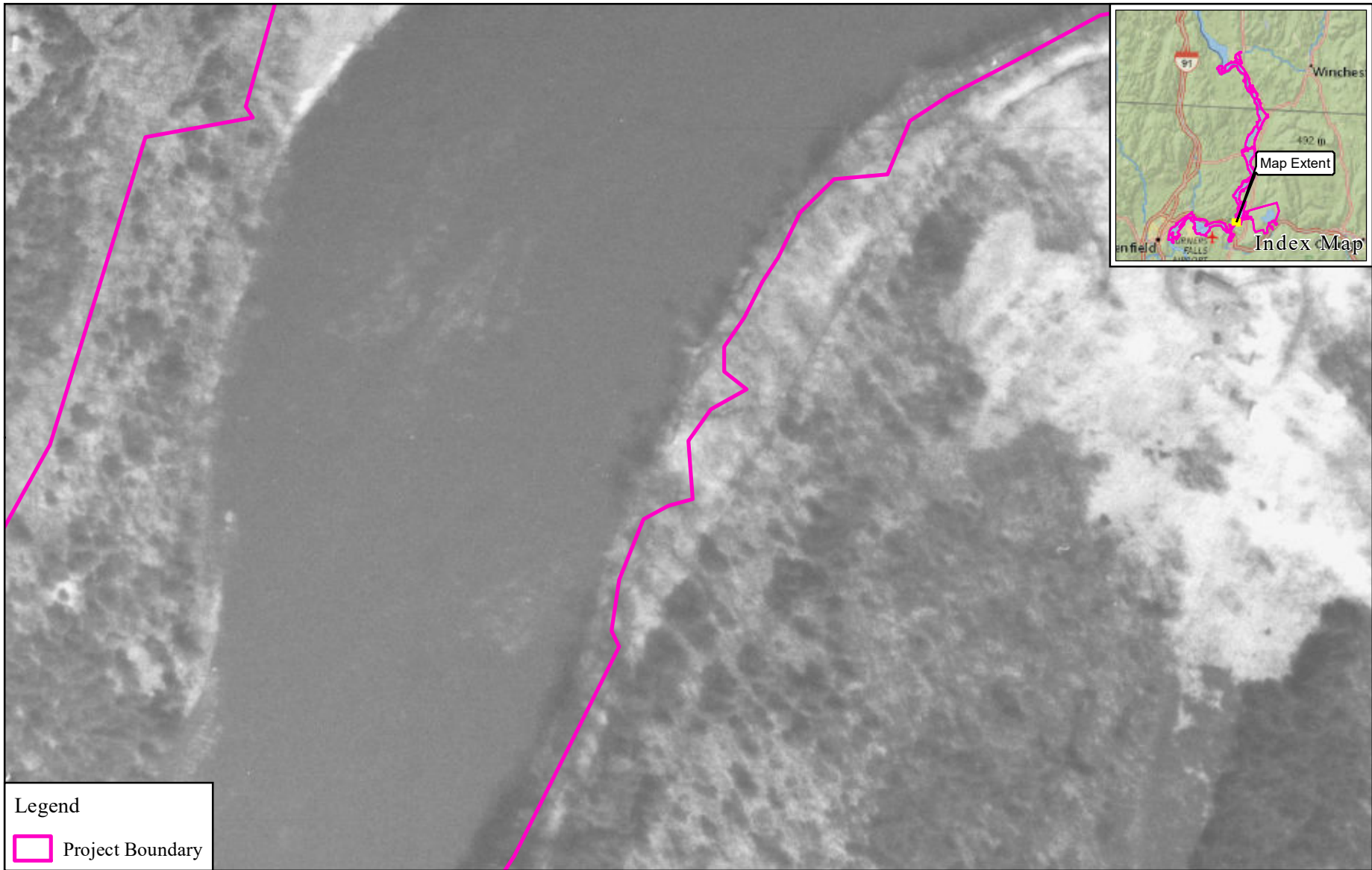

FIRSTLIGHT HYDRO GENERATING COMPANY  
 Northfield Mountain Pumped Storage Project No. 2485  
 Turners Falls Hydroelectric Project No. 1889

STUDY 3.1.2




River Road  
 1952 Imagery  
 (Source: North by Northeast Survey Company)

Copyright © 2016 FirstLight Power Resources All rights reserved.



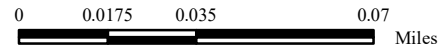
Legend

 Project Boundary




FIRSTLIGHT HYDRO GENERATING COMPANY  
 Northfield Mountain Pumped Storage Project No. 2485  
 Turners Falls Hydroelectric Project No. 1889

STUDY 3.1.2




River Road  
 1960's Imagery  
 (Source: USGS)

Copyright © 2016 FirstLight Power Resources All rights reserved.



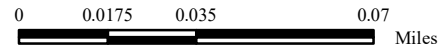
**Legend**

 Project Boundary



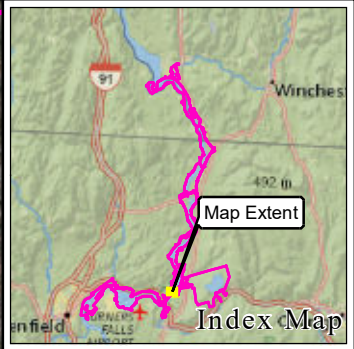

FIRSTLIGHT HYDRO GENERATING COMPANY  
 Northfield Mountain Pumped Storage Project No. 2485  
 Turners Falls Hydroelectric Project No. 1889

**STUDY 3.1.2**





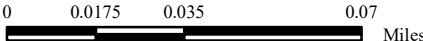
River Road  
 1990's Imagery  
 (Source: MassGIS)

Copyright © 2016 FirstLight Power Resources All rights reserved.

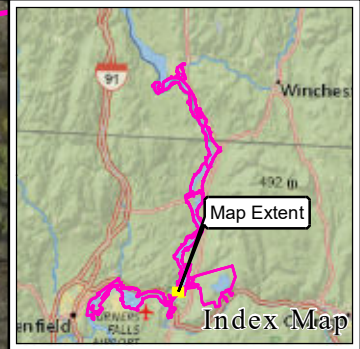


**Legend**


 Project Boundary


	<p>FIRSTLIGHT HYDRO GENERATING COMPANY          Northfield Mountain Pumped Storage Project No. 2485          Turners Falls Hydroelectric Project No. 1889</p> <p><b>STUDY 3.1.2</b></p>	<p>River Road          2008-2010 Imagery          (Source: MassGIS)</p>
		


Copyright © 2016 FirstLight Power Resources All rights reserved.



**Legend**

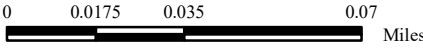
 Project Boundary





FIRSTLIGHT HYDRO GENERATING COMPANY  
 Northfield Mountain Pumped Storage Project No. 2485  
 Turners Falls Hydroelectric Project No. 1889  
**STUDY 3.1.2**

River Road  
 2014 Imagery  
 (Source: NAIP)

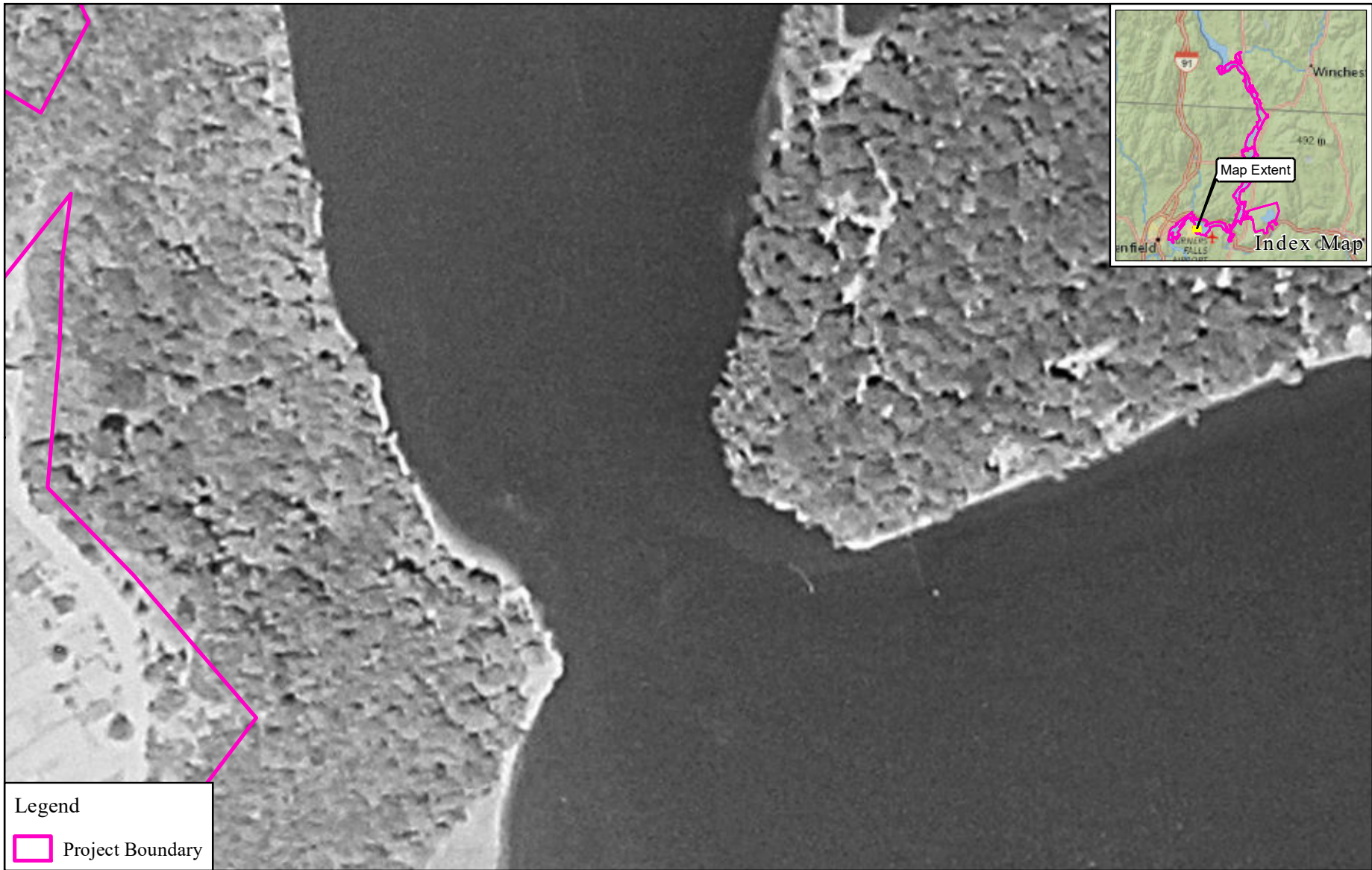


Miles

Copyright © 2016 FirstLight Power Resources All rights reserved.


## **20 CAMPGROUND POINT**


Campground Point is the peninsula that separates Barton Cove from the reach of river leading upstream to French King Gorge. Some erosion is evident in the earlier photographs such as 1952 continuing through the 2008 photograph, when it was stabilized as part of the ECP in 2008 as the Campground Point Site. The 2014 photograph shows an increase in vegetation on the stabilized site.



Legend

 Project Boundary

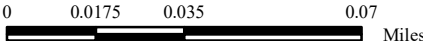




FIRSTLIGHT HYDRO GENERATING COMPANY  
 Northfield Mountain Pumped Storage Project No. 2485  
 Turners Falls Hydroelectric Project No. 1889

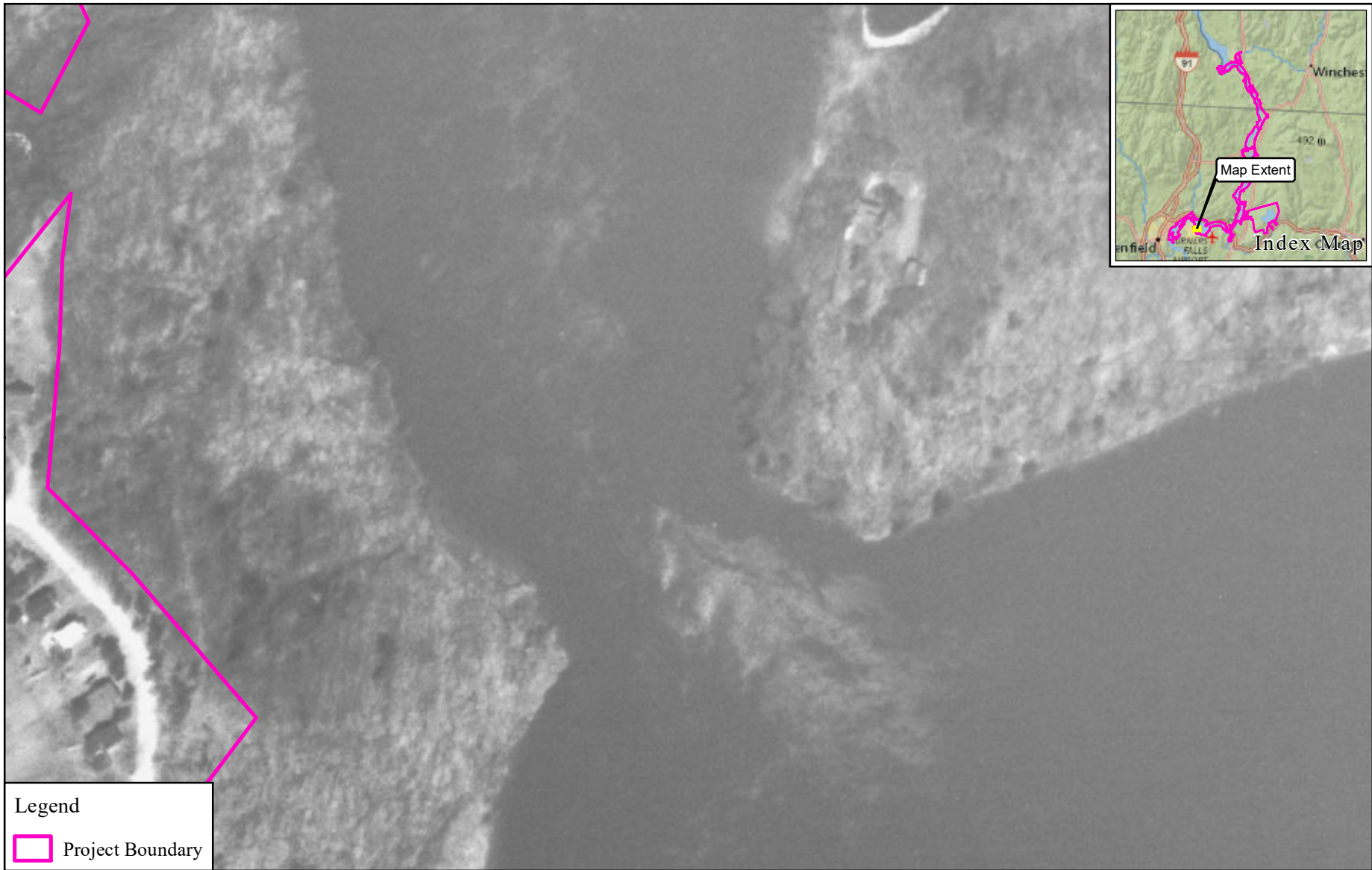
STUDY 3.1.2

Campground Point  
 1952 Imagery  
 (Source: North by Northeast Survey Company)






0 0.0175 0.035 0.07 Miles

Copyright © 2016 FirstLight Power Resources All rights reserved.

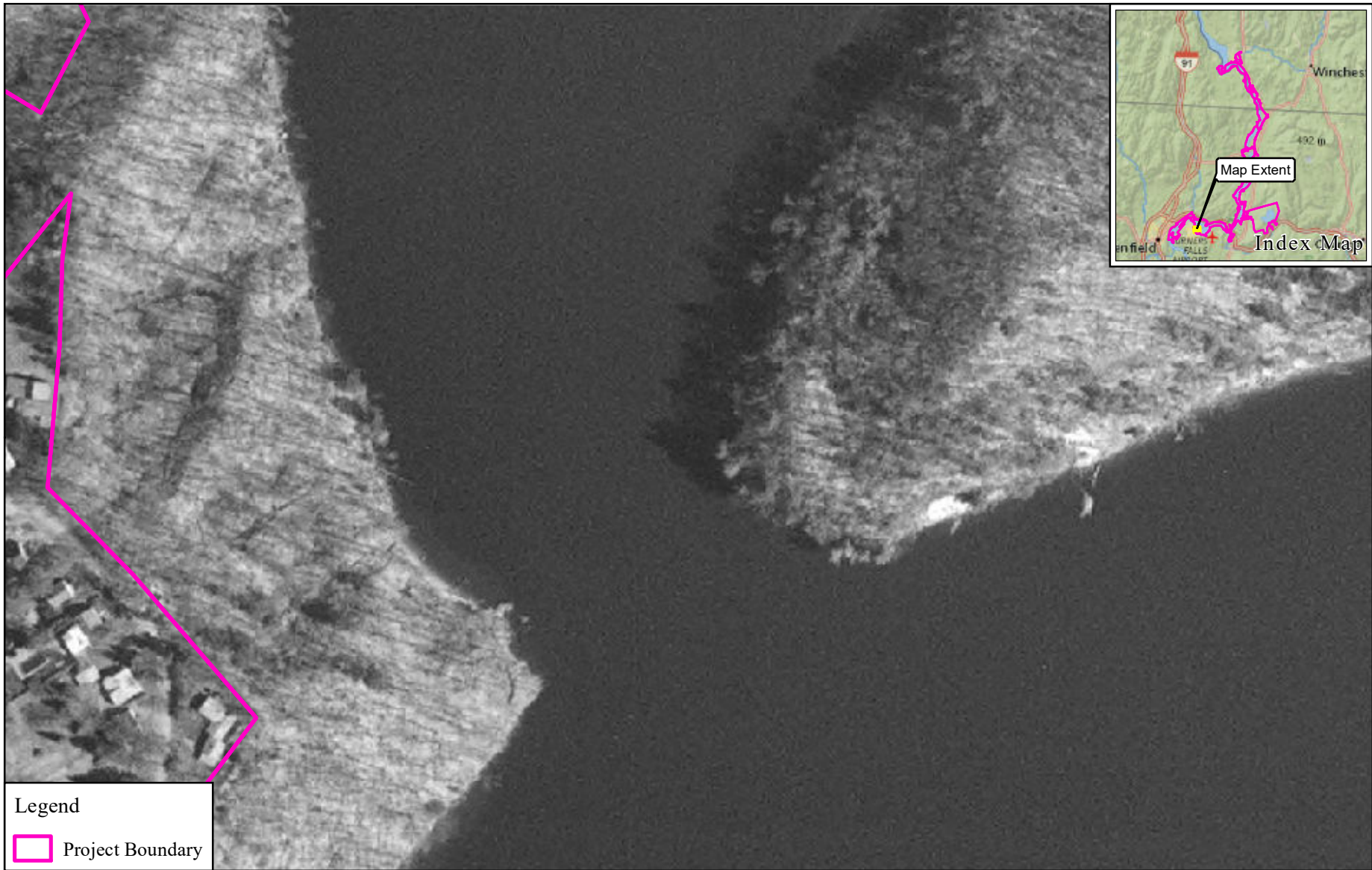


Legend


 Project Boundary

	<p>FIRSTLIGHT HYDRO GENERATING COMPANY          Northfield Mountain Pumped Storage Project No. 2485          Turners Falls Hydroelectric Project No. 1889</p> <p>STUDY 3.1.2</p> <p>0    0.0175    0.035    0.07   Miles</p>	<p>Campground Point          1960's Imagery          (Source: USGS)</p>
		
Copyright © 2016 FirstLight Power Resources All rights reserved.		





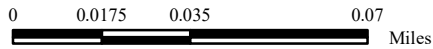
**Legend**

 Project Boundary




FIRSTLIGHT HYDRO GENERATING COMPANY  
 Northfield Mountain Pumped Storage Project No. 2485  
 Turners Falls Hydroelectric Project No. 1889

STUDY 3.1.2




Campground Point  
 1990's Imagery  
 (Source: MassGIS)

Copyright © 2016 FirstLight Power Resources All rights reserved.

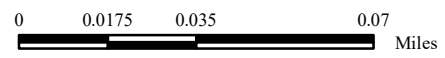


**Legend**

 Project Boundary




FIRSTLIGHT HYDRO GENERATING COMPANY  
 Northfield Mountain Pumped Storage Project No. 2485  
 Turners Falls Hydroelectric Project No. 1889  
**STUDY 3.1.2**




Campground Point  
 2008-2010 Imagery  
 (Source: MassGIS)

Copyright © 2016 FirstLight Power Resources All rights reserved.

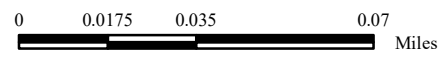


**Legend**

 Project Boundary



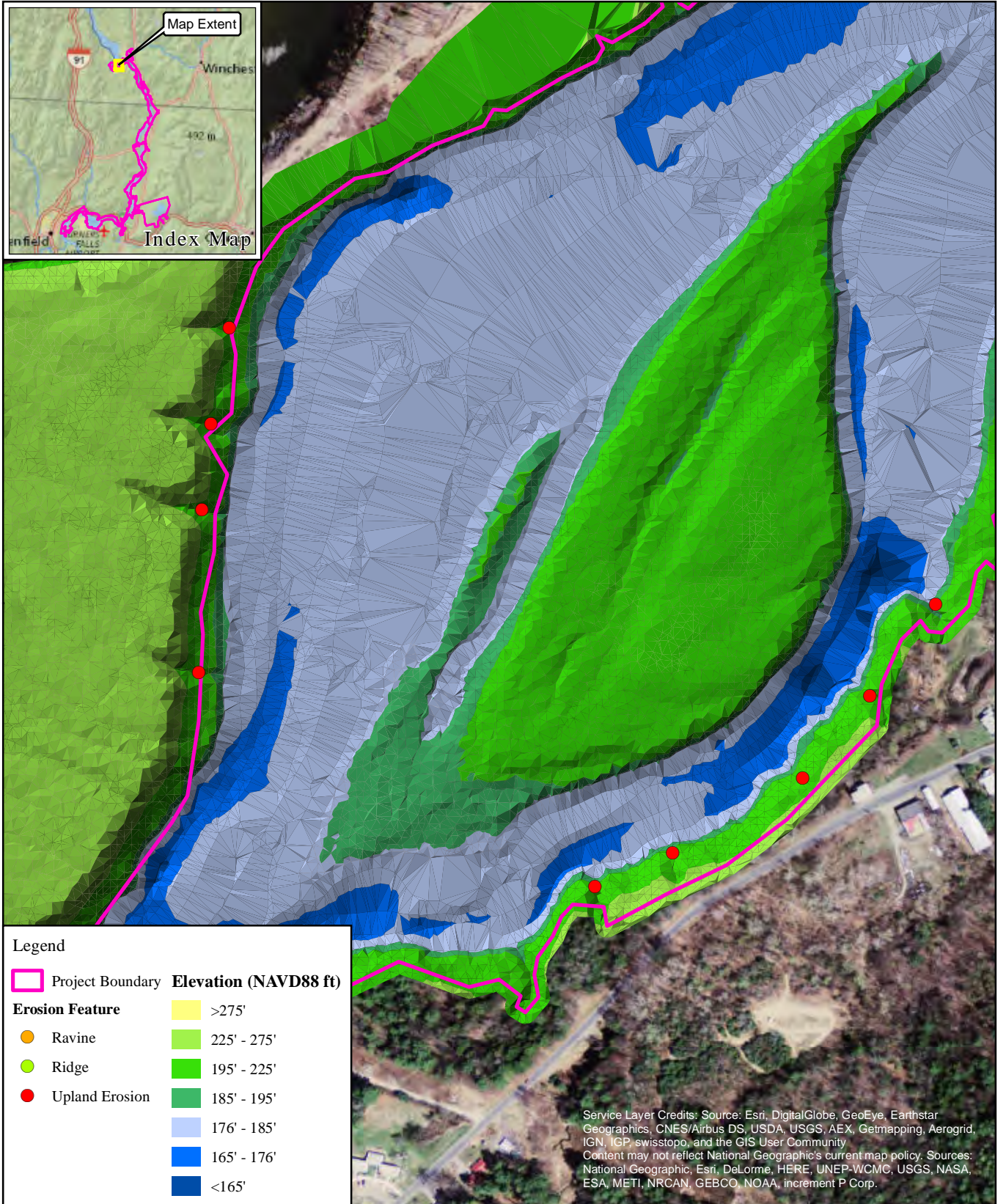
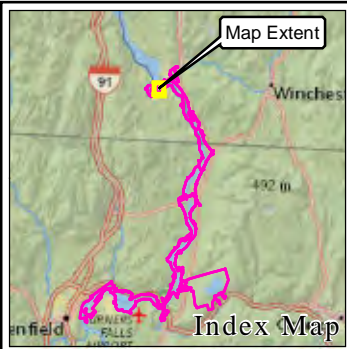

FIRSTLIGHT HYDRO GENERATING COMPANY  
 Northfield Mountain Pumped Storage Project No. 2485  
 Turners Falls Hydroelectric Project No. 1889  
**STUDY 3.1.2**



Campground Point  
 2014 Imagery  
 (Source: NAIP)

Copyright © 2016 FirstLight Power Resources All rights reserved.

# **APPENDIX C – UPLAND EROSION FEATURES**



**Legend**

	Project Boundary	<b>Elevation (NAVD88 ft)</b>
		>275'
	Ravine	225' - 275'
	Ridge	195' - 225'
	Upland Erosion	185' - 195'
		176' - 185'
		165' - 176'
		<165'

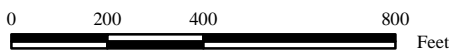
Service Layer Credits: Source: Esri, DigitalGlobe, GeoEye, Earthstar Geographics, CNES/Airbus DS, USDA, USGS, AEX, Getmapping, Aerogrid, IGN, IGP, swisstopo, and the GIS User Community  
 Content may not reflect National Geographic's current map policy. Sources: National Geographic, Esri, DeLorme, HERE, UNEP-WCMC, USGS, NASA, ESA, METI, NRCAN, GEBCO, NOAA, Increment P Corp.



FIRSTLIGHT HYDRO GENERATING COMPANY  
 Northfield Mountain Pumped Storage Project No. 2485  
 Turners Falls Hydroelectric Project No. 1889

**STUDY 3.1.2**

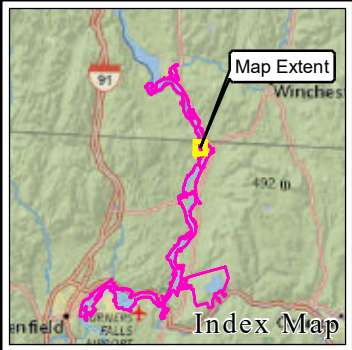
**C-1 Upland Erosion near Stebbins Island**



Copyright © 2016 FirstLight Power Resources All rights reserved.

**Figure C-2 Right bank upstream-most upland erosion feature (Stream)**





**Legend**

	Project Boundary	<b>Elevation (NAVD88 ft)</b>
	Ravine	>275'
	Ridge	225' - 275'
	Upland Erosion	195' - 225'
		185' - 195'
		176' - 185'
		165' - 176'
		<165'

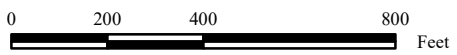
Service Layer Credits: Source: Esri, DigitalGlobe, GeoEye, Earthstar Geographics, CNES/Airbus DS, USDA, USGS, AEX, Getmapping, Aerogrid, IGN, IGP, swisstopo, and the GIS User Community  
 Content may not reflect National Geographic's current map policy. Sources: National Geographic, Esri, DeLorme, HERE, UNEP-WCMC, USGS, NASA, ESA, METI, NRCAN, GEBCO, NOAA, increment P Corp.



FIRSTLIGHT HYDRO GENERATING COMPANY  
 Northfield Mountain Pumped Storage Project No. 2485  
 Turners Falls Hydroelectric Project No. 1889

STUDY 3.1.2

C-3 Ravine Erosional Feature



Copyright © 2016 FirstLight Power Resources All rights reserved.

**Figure C-4. Looking downhill into ravine (Photo 272, 9/29/2015)**



**Figure C-5. From ravine looking uphill (Photo 288, 9/29/2015)**



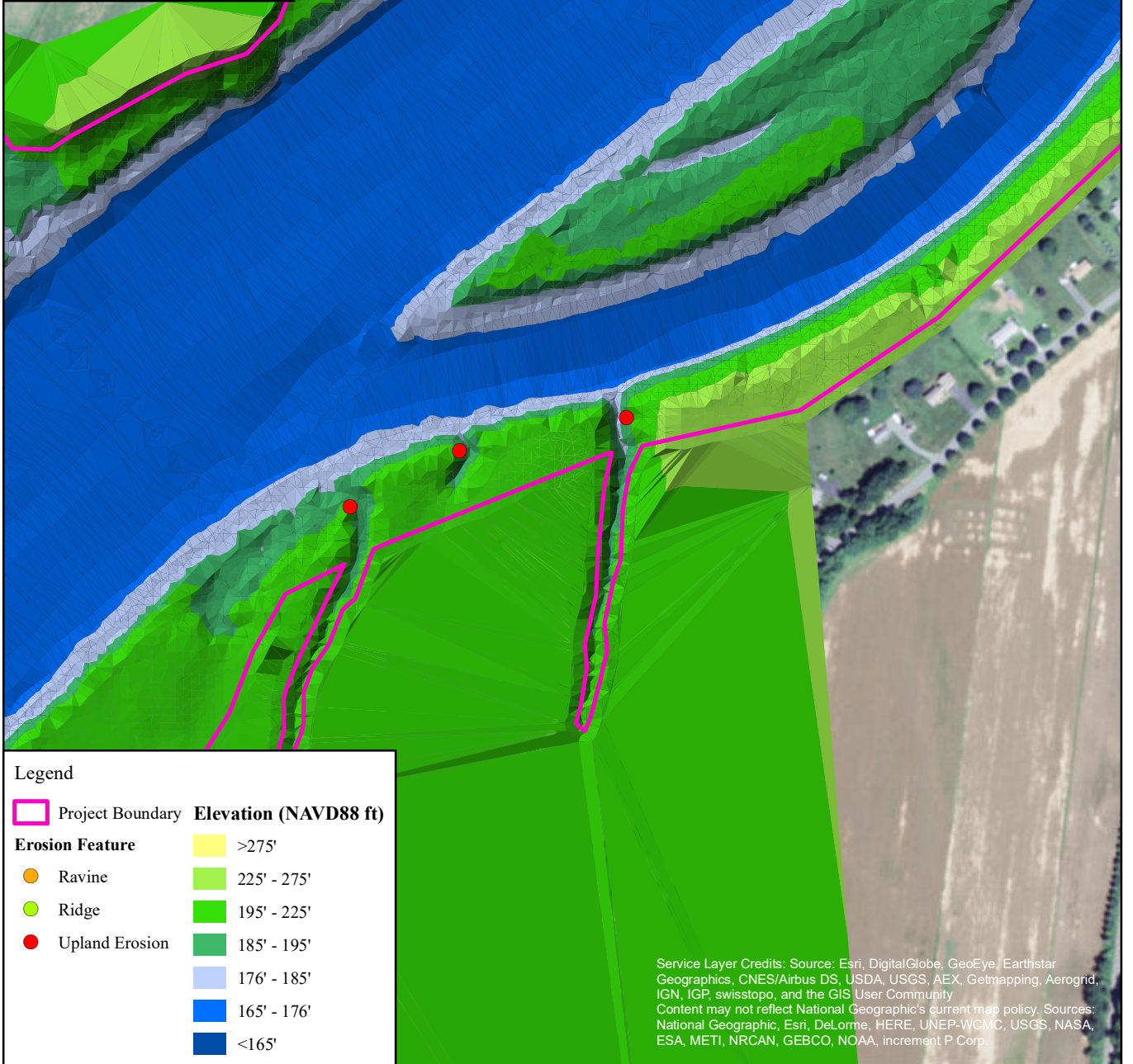
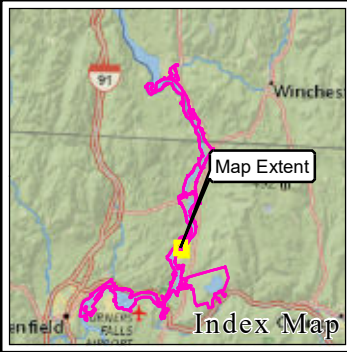


**Figure C-6 From second ravine looking uphill (Photo 316, 9/29/2015)**



**Figure C-7 Divide between two ravines (Photo 325, 9/29/2015)**





Legend	
	Project Boundary
<b>Erosion Feature</b>	<b>Elevation (NAVD88 ft)</b>
	Ravine
	Ridge
	Upland Erosion
	>275'
	225' - 275'
	195' - 225'
	185' - 195'
	176' - 185'
	165' - 176'
	<165'

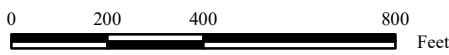
Service Layer Credits: Source: Esri, DigitalGlobe, GeoEye, Earthstar Geographics, CNES/Airbus DS, USDA, USGS, AEX, Getmapping, Aerogrid, IGN, IGP, swisstopo, and the GIS User Community  
 Content may not reflect National Geographic's current map policy. Sources: National Geographic, Esri, DeLorme, HERE, UNEP-WCMC, USGS, NASA, ESA, METI, NRCAN, GEBCO, NOAA, increment P Corp.



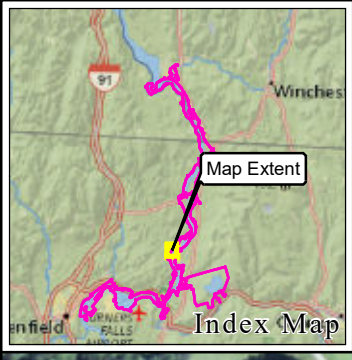
FIRSTLIGHT HYDRO GENERATING COMPANY  
 Northfield Mountain Pumped Storage Project No. 2485  
 Turners Falls Hydroelectric Project No. 1889

STUDY 3.1.2

C-8 Upland Erosion Near  
 Kidds Island (Left Bank)



Copyright © 2016 FirstLight Power Resources All rights reserved.



**Legend**

	Project Boundary	<b>Elevation (NAVD88 ft)</b>
	Ravine	>275'
	Ridge	225' - 275'
	Upland Erosion	195' - 225'
		185' - 195'
		176' - 185'
		165' - 176'
		<165'

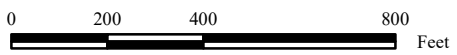
Service Layer Credits: Source: Esri, DigitalGlobe, GeoEye, Earthstar Geographics, CNES/Airbus DS, USDA, USGS, AEX, Getmapping, Aerogrid, IGN, IGP, swisstopo, and the GIS User Community  
 Content may not reflect National Geographic's current map policy. Sources: National Geographic, Esri, DeLorme, HERE, UNEP-WCMC, USGS, NASA, ESA, METI, NRCAN, GEBCO, NOAA, increment P Corp.



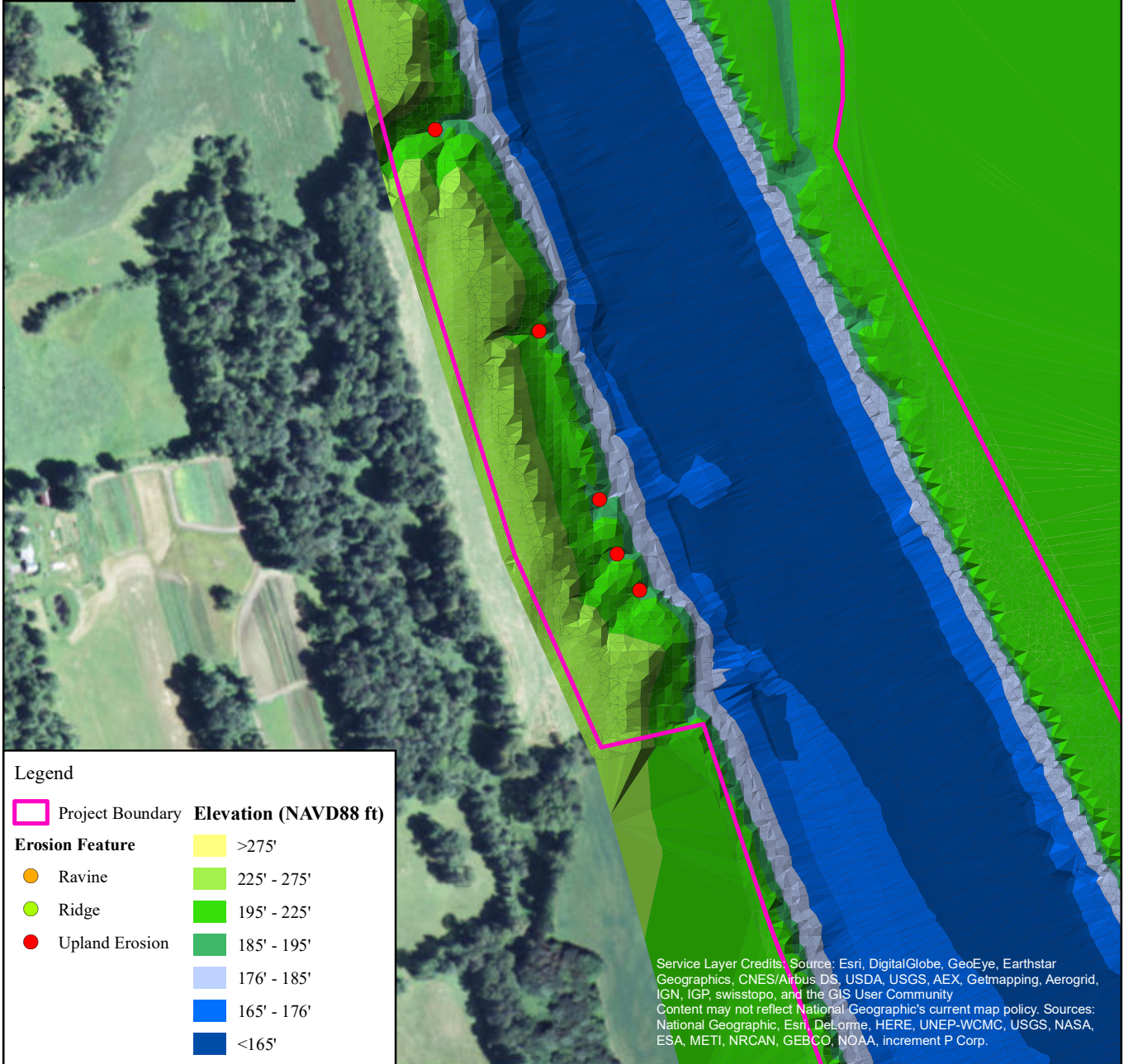
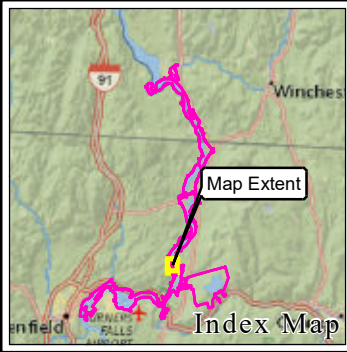
FIRSTLIGHT HYDRO GENERATING COMPANY  
 Northfield Mountain Pumped Storage Project No. 2485  
 Turners Falls Hydroelectric Project No. 1889

STUDY 3.1.2

C-9 Upland Erosion  
 Downstream of Kidds  
 Island (Right Bank)



Copyright © 2016 FirstLight Power Resources All rights reserved.



**Legend**

	Project Boundary	<b>Elevation (NAVD88 ft)</b>
	Ravine	>275'
	Ridge	225' - 275'
	Upland Erosion	195' - 225'
		185' - 195'
		176' - 185'
		165' - 176'
		<165'

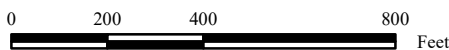
Service Layer Credits: Source: Esri, DigitalGlobe, GeoEye, Earthstar Geographics, CNES/Airbus DS, USDA, USGS, AEX, Getmapping, Aerogrid, IGN, IGP, swisstopo, and the GIS User Community  
 Content may not reflect National Geographic's current map policy. Sources: National Geographic, Esri, DeLorme, HERE, UNEP-WCMC, USGS, NASA, ESA, METI, NRCAN, GEBCO, NOAA, increment P Corp.



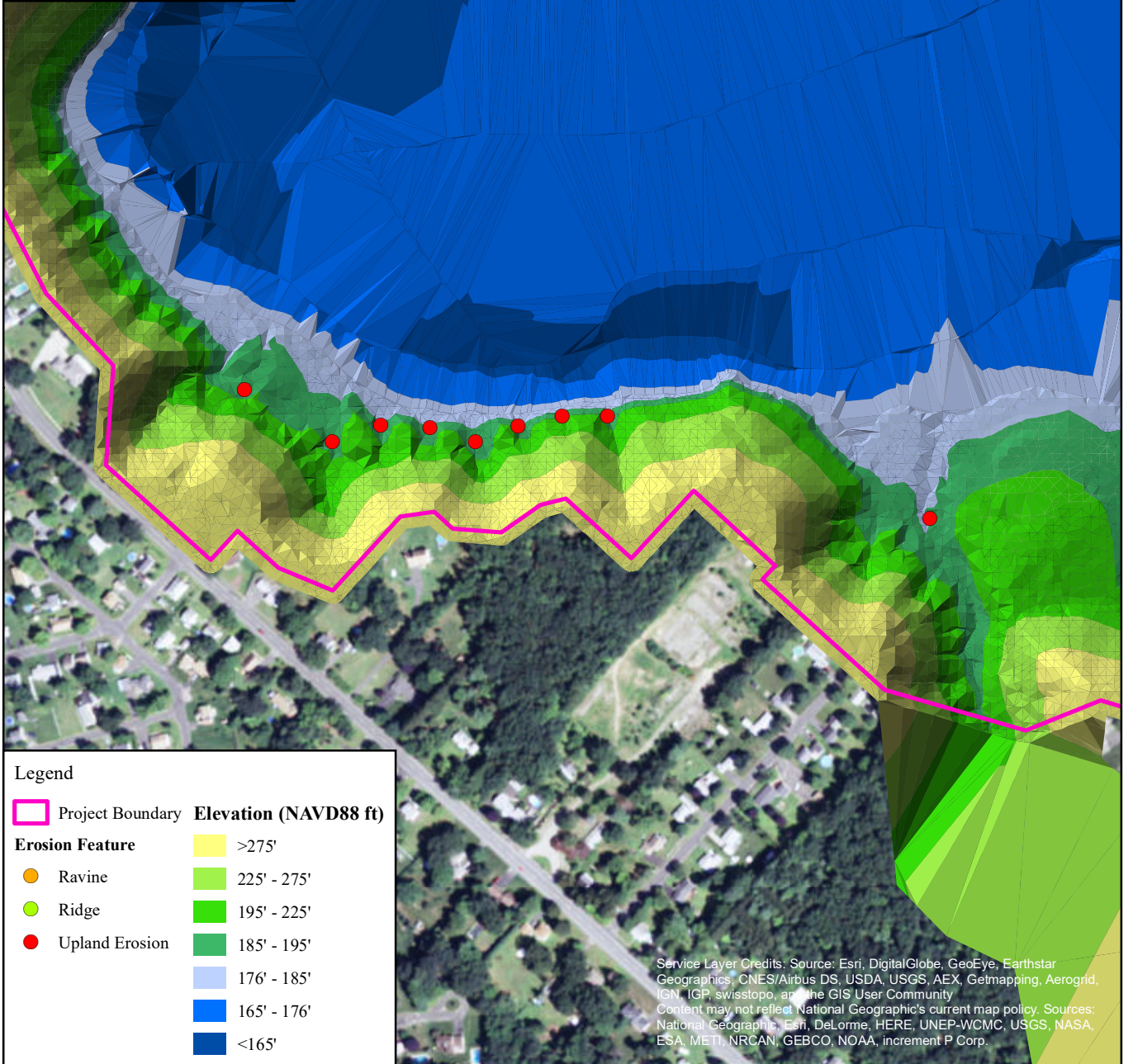
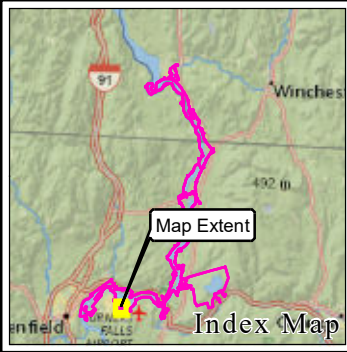
FIRSTLIGHT HYDRO GENERATING COMPANY  
 Northfield Mountain Pumped Storage Project No. 2485  
 Turners Falls Hydroelectric Project No. 1889

**STUDY 3.1.2**

**C-10 Upland Erosion**



Copyright © 2016 FirstLight Power Resources All rights reserved.



Legend

	Project Boundary	<b>Elevation (NAVD88 ft)</b>
	Ravine	>275'
	Ridge	225' - 275'
	Upland Erosion	195' - 225'
		185' - 195'
		176' - 185'
		165' - 176'
		<165'

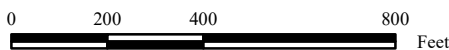
Service Layer Credits: Source: Esri, DigitalGlobe, GeoEye, Earthstar Geographics, CNES/Airbus DS, USDA, USGS, AEX, Getmapping, Aerogrid, IGN, IGP, swisstopo, and the GIS User Community  
 Content may not reflect National Geographic's current map policy. Sources: National Geographic, Esri, DeLorme, HERE, UNEP-WCMC, USGS, NASA, ESA, METI, NRCAN, GEBCO, NOAA, increment P Corp.



FIRSTLIGHT HYDRO GENERATING COMPANY  
 Northfield Mountain Pumped Storage Project No. 2485  
 Turners Falls Hydroelectric Project No. 1889

STUDY 3.1.2

C-11 Upland Erosion near  
 Montague Rod and Gun  
 Club



Copyright © 2016 FirstLight Power Resources All rights reserved.

**Figure C-12 Upland erosion feature (Photo 9517)**



# **APPENDIX D – DETAILED STUDY SITE ASSESSMENTS**

**Synopsis of Land-Based Surveys  
2014 Connecticut River Detailed Site Assessments**

Location ID	Date	Station (Note 1)	Coordinates		Left or Right Bank (Note 2)	Previously Stabilized?	Photo Reference No.
			Latitude	Longitude			
11L	9/23/14	10,000+00	42.77306	-72.50294	Left	No	802 - 807
2L	Not Surveyed (Note 3)	945+00	42.77062	-72.48576	Left	Yes (Bonnette Farm)	Not Surveyed (Note 3)
3L	9/23/14	795+00	42.73602	-72.45993	Left	No	808 - 814
3R	9/23/14	795+00	42.73457	-72.46257	Right	Yes (Kendall)	815 - 820
4L	9/23/14	737+00	42.71964	-72.45590	Left	No	821-824
4AL	9/23/14	738+00	42.71993	-72.45606	Left	No	825 - 830
5CR	9/23/14	572+50	42.68102	-72.47197	Right	No	831 - 835
10L	9/24/14	490+00	42.66099	-72.46698	Left	No	855 - 858
10R	9/24/14	490+00	42.65999	-72.46927	Right	Yes (Urgiel Upstream)	850 - 854
6AL	9/24/14	417+50	42.64249	-72.47578	Left	Yes (Skalaski)	859 - 864
6AR	Not Surveyed (Note 4)	417+50	42.64470	-72.48036	Right	Yes (Flagg)	Not Surveyed (Note 4)
7L	9/25/14	375+00	42.63684	-72.48664	Left	No	871 - 877
7R	9/25/14	375+00	42.63824	-72.49010	Right	No	879 - 884
8BL	9/25/14	327+50	42.62466	-72.48204	Left	No	885 - 891
8BR	Not Surveyed (Note 5)	327+50	42.62256	-72.48390	Right	No	Not Surveyed (Note 5)
9R	Not Surveyed (Note 6)	65+00	42.59856	-72.54261	Right	Yes (Campground Point)	Not Surveyed (Note 6)
BC-1R	9/24/14	47+50	42.59935	-72.54431	Right	No	836 - 843
303L	9/22/14	940+00	42.76950	-72.48410	Left	No	795 - 799
119BL	9/24/14	407+00	42.64167	-72.47889	Left	No	866, 867, 869, 870
87BL	9/25/14	307+50	42.61982	-72.47829	Left	No	892 - 897
75L	9/25/14	270+00	42.60946	-72.48226	Left	No	898 - 904
12BL	Not Surveyed (Note 7)	67+50	42.59425	-72.54115	Left	Yes (Montague)	Not Surveyed (Note 7)
18L	Not Surveyed (Note 8)	870+00	42.75252	-72.47180	Left	No	Not Surveyed (Note 8)
21R		792+50	42.73313	-72.46147	Right	No	
29R		660+00	42.70262	-72.46536	Right	No	
26R		500+00	42.66106	-72.47071	Right	No	

Notes: (1) Station is measured in feet, with Station 0+00 at Turners Fall Dam, increasing upstream.

- (2) Left and right bank is referenced facing downstream.
- (3) Transect 2L was surveyed as land-based observation point #19 (Sta. 947+50) in November 2013.
- (4) Transect 6AR was surveyed as land-based observation point #25 (Sta. 410+00) in November 2013.
- (5) Transect 8BR was surveyed as land-based observation point #23 (Sta. 321+00) in November 2013.
- (6) Transect 9R was surveyed as land-based observation point #27 (Sta. 62+00) in November 2013.
- (7) Boat-based point 12BL was surveyed as land-based observation point #28 (Sta. 65+00) in November 2013.
- (8) Land-based points #18L, 21R, 29R, and 26R were surveyed in November 2013.



# Connecticut River – Turners Falls Impoundment Riverbank Detailed Site Assessments

Location ID: 11L

Personnel: YKC, CM, RKS

Date: September 23, 2014

Time: 10:40 AM

Photo Reference Numbers: 802 - 807

Station Number: 1000+00

Latitude: 42.77306

Longitude: -72.50294

Left or Right Bank (Looking Downstream): Left

Previously Stabilized? No

## Geologic / Geotechnical Observations:

### Stratigraphy:

(Refer to Site Sketch below for locations of soil/rock layers)

Notations in parentheses are based on Unified Soil Classification System)

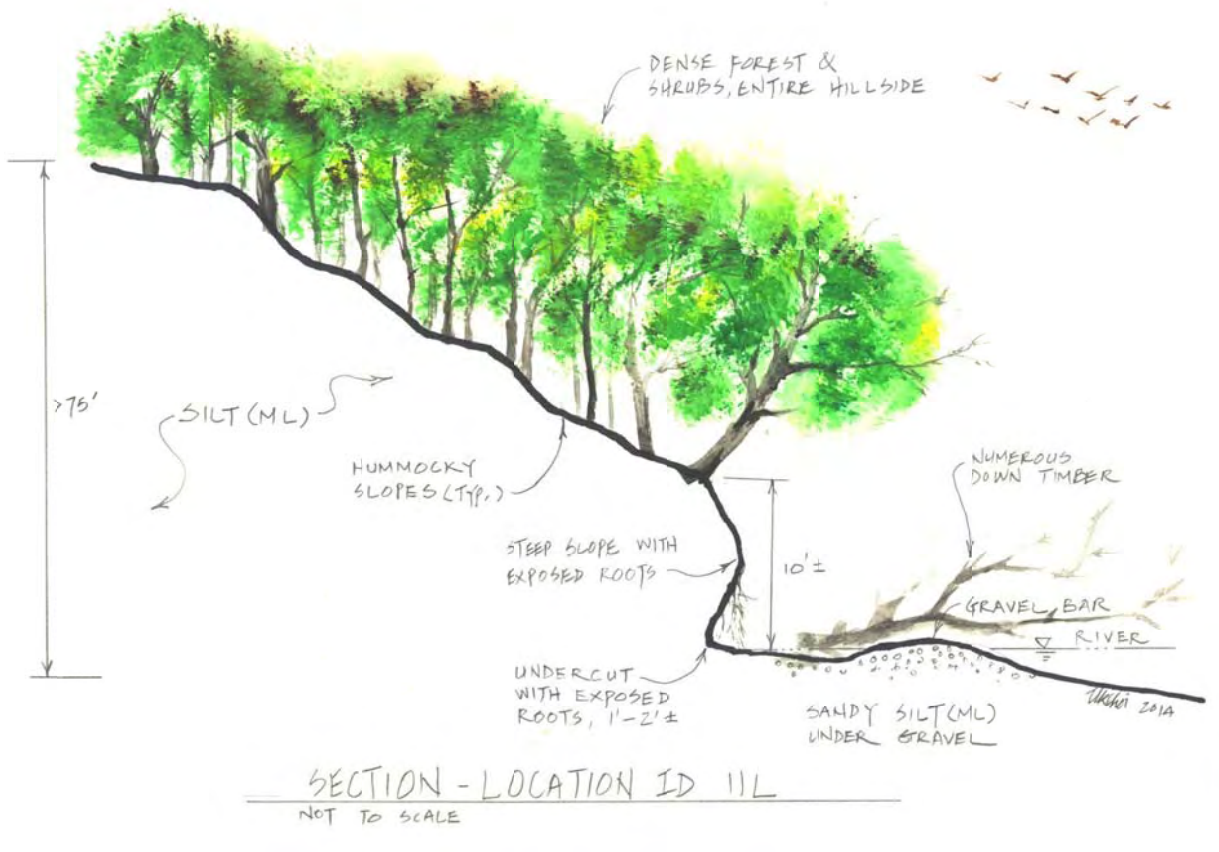
Upper Bank: SILT (ML) – Low plasticity, <10% fine sand, light brown.

Lower Bank below Gravel Bar: SANDY SILT (ML) – Low plasticity, approx. 20% - 30% fine sand, gray.

## Observed Erosion Features:

- Steep slope at river level (lower 10 feet of Upper Bank)
- Mass wasting with hummocky terrain in upland
- Undercuts with exposed roots
- Some leaning trees
- Numerous down timber

## Site Sketch:



# Connecticut River – Turners Falls Impoundment Riverbank Classification for Land Based Survey

Observation Point Number: 11L      Date: September 23, 2014

Station Number:      1000+00

## Bank Vegetation:

Top: Heavy (90%) cover – Broad leaved deciduous tree

Tree (90%): red oak\*, eastern white pine, red maple, silver maple, black birch, yellow birch

Shrub (80%): staghorn sumac, willow, birch, dead snags (>3), multiflora rose

Vine: bittersweet\*, Virginia creeper, grape

Face: Heavy (>50%) cover – Broad leaved deciduous tall shrub/sapling

Tree (25%): red maple\*, black birch, eastern white pine, red oak, basswood

Shrub (70%): sumac\*, red maple sapling, multiflora rose, Japanese barberry

Vine: oriental bittersweet\*, grape, Virginia creeper

Herbaceous (45%): river rye\*, woolgrass, boneset, beggartick (Bidens spp.), mixed goldenrods (Solidago spp.), cattails, Iris, mixed asters, purple loosestrife

Toe: Sparse (<5%) – mixed emergent (broad-leaved & narrow leaved, persistent & non-persistent)

Herbaceous: rushes (inc. Juncus, Eleocharis), Sagittaria spp., Phalaris, Iris, mixed grasses

\* Dominant species in each vegetative strata is marked with an \*

The dominant vegetative strata is the tallest strata with >30% cover

## Adjacent Land Use:

Forested further back from restoration site, & Agricultural (row crop – cow corn)

## Sensitive Receptor:

No

## Notes:

Bank is densely vegetated and very steep

Eroding bank with overhanging roots

Bald eagle nest nearby (upstream)

Transect continues through Stebbins Island and on to Right bank across River

Invasive vegetation including multiflora rose, creeper, bittersweet & loosestrife

2014 Connecticut River Detailed Site Assessments  
Land-Based Survey Photographs Reference No. 802 - 807  
Location ID 11L – September 23, 2014



Photo No. 802



Photo No. 803

**2014 Connecticut River Detailed Site Assessments  
Land-Based Survey Photographs Reference No. 802 - 807  
Location ID 11L – September 23, 2014**



Photo No. 804



Photo No. 805

**2014 Connecticut River Detailed Site Assessments  
Land-Based Survey Photographs Reference No. 802 - 807  
Location ID 11L – September 23, 2014**



Photo No. 806



Photo No. 807

# Connecticut River – Turners Falls Impoundment Riverbank Detailed Site Assessments

Location ID: 3L

Personnel: YKC, CM, RKS

Date: September 23, 2014

Time: 12:05 PM

Photo Reference Numbers: 808 - 814

Station Number: 795 + 00

Latitude: 42.73602

Longitude: -72.45993

Left or Right Bank (Looking Downstream): Left

Previously Stabilized? No

## Geologic / Geotechnical Observations:

### Stratigraphy:

(Refer to Site Sketch below for locations of soil/rock layers)

Notations in parentheses are based on Unified Soil Classification System)

Upper Bank Upper Layer: SILTY SAND (SM) – Fine to coarse sand, approx. 10% - 20% gravel, approx. 10% - 20% low-plasticity fines, brown.

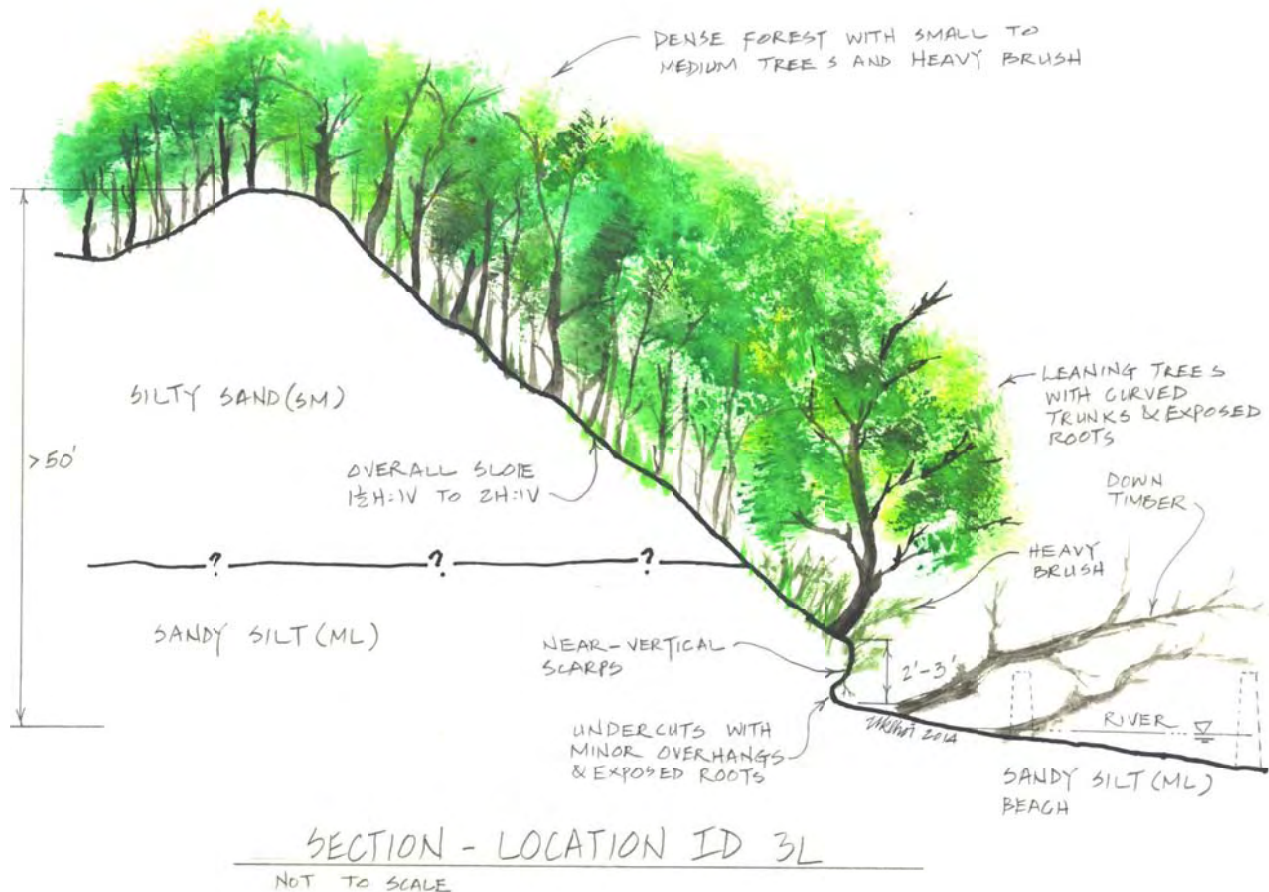
Upper Bank Lower Layer: SANDY SILT (ML) – Low plasticity, approx. 20% - 30% very fine sand, gray.

Lower Bank: SANDY SILT (ML) – same as Lower Layer of Upper Bank.

## Observed Erosion Features:

- Near vertical scarps with undercuts and exposed roots at river level
- Minor overhangs
- Leaning trees with curved trunks
- Some mass-wasting near river level

## Site Sketch:



# Connecticut River – Turners Falls Impoundment Riverbank Classification for Land Based Survey

Observation Point Number: 3L      Date: September 23, 2014

Station Number: 795+00

## Bank Vegetation:

### Top: Heavy (>50%) cover – Broad leaved deciduous tree

Tree (90%): red oak\*, silver maple, green ash, sycamore, elm, basswood, black birch, eastern white pine

Shrub (85%): barberry\*, multiflora rose, black birch saplings, eastern white pine saplings, red maple saplings

Vine (45%): oriental bittersweet\*

Herbaceous (30%): cinnamon fern, sensitive fern, lady fern, mixed asters, mixed goldenrods (Solidago spp.)

### Face: Heavy (>50%) cover – Broad leaved deciduous tree

Tree (80%): red oak\*, elm, black birch, ash, sycamore, basswood

Shrub/sapling (90%): basswood\*, black birch, elm, ash, autumn olive, Japanese barberry, willow, white oak, staghorn sumac, multiflora rose

Herbaceous (80%): Mixed grasses (Phalaris arundinacea\*, Calamagrostis canadensis), mixed goldenrods (Solidago spp.), mixed asters, cutgrass (Leersia oryzoides), beggartick (Bidens spp.), purple loosestrife, panic grass, clover

### Toe: None

\* Dominant species in each vegetative strata is marked with an \*

The dominant vegetative strata is the tallest strata with >30% cover

## Adjacent Land Use:

Forested & Agricultural

## Sensitive Receptor:

No

## Notes:

Near vertical erosion scarps with undercuts.

Leaning/downed trees at river level.

Narrow riparian forest with Japanese barberry dominating the understory, with agricultural fields (potato) at the top of the hill.

Invasive species present (bittersweet & barberry common, some loosestrife & autumn olive present)

2014 Connecticut River Detailed Site Assessments  
Land-Based Survey Photographs Reference No. 808 - 814  
Location ID 3L – September 23, 2014



Photo No. 808



Photo No. 809



**2014 Connecticut River Detailed Site Assessments  
Land-Based Survey Photographs Reference No. 808 - 814  
Location ID 3L – September 23, 2014**



Photo No. 810

**2014 Connecticut River Detailed Site Assessments  
Land-Based Survey Photographs Reference No. 808 - 814  
Location ID 3L – September 23, 2014**



Photo No. 811



Photo No. 812

**2014 Connecticut River Detailed Site Assessments  
Land-Based Survey Photographs Reference No. 808 - 814  
Location ID 3L – September 23, 2014**



Photo No. 813

**2014 Connecticut River Detailed Site Assessments  
Land-Based Survey Photographs Reference No. 808 - 814  
Location ID 3L – September 23, 2014**



Photo No. 814

# Connecticut River – Turners Falls Impoundment Riverbank Detailed Site Assessments

Location ID: 3R

Personnel: YKC, CM, RKS

Date: September 23, 2014

Time: 12:40 PM

Photo Reference Numbers: 815 - 820

Station Number: 795 + 00

Latitude: 42.73457

Longitude: -72.46257

Left or Right Bank (Looking Downstream): Right

Previously Stabilized? Yes (Kandall Site, 2008)

## Geologic / Geotechnical Observations:

### Stratigraphy:

(Refer to Site Sketch below for locations of soil/rock layers)

Notations in parentheses are based on Unified Soil Classification System)

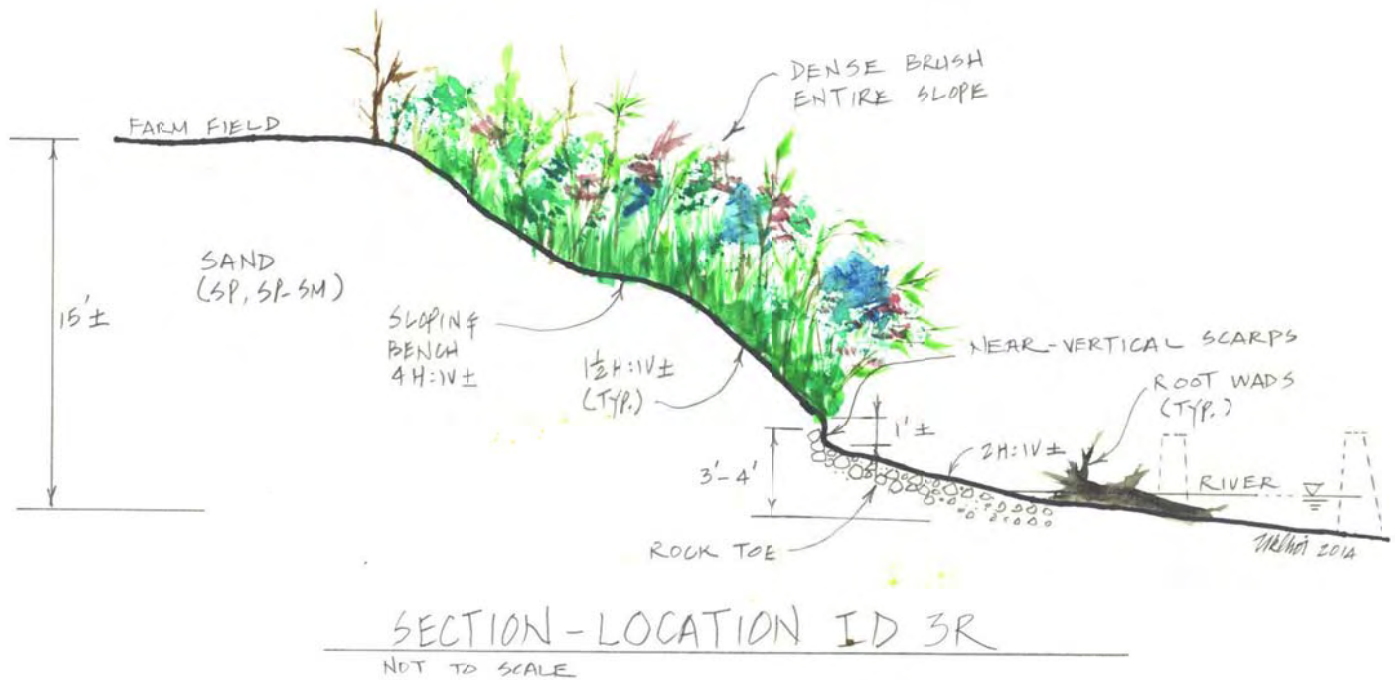
SAND (SP, SP-SM) – Fine sand, approx. 5% - 10% low-plasticity fines, brown.

ROCK TOE – 1" – 4" riprap rock, angular, hard, minor deterioration.

## Observed Erosion Features:

- Little erosion of stabilized slope.
- Minor near-vertical scarps near the top of rock toe

## Site Sketch:



# Connecticut River – Turners Falls Impoundment Riverbank Classification for Land Based Survey

Observation Point Number: 3R

Date: September 23, 2014

Station Number: 795+00

## Bank Vegetation:

Top: Heavy (>50%) cover – Broad leaved deciduous tall shrub/sapling

Tree (1%): pin oak (fringe)

Shrub (80%): staghorn sumac\*, willows, dogwoods, loosestrife, ash, red maple, Ilex glabra

Herbaceous: Aster\*, mixed grasses

Face: Heavy (>50%) cover – Broad leaved deciduous tall shrub/sapling

Tree (0%)

Shrub/sapling (60%): willow\*, sumac, loosestrife, dogwood, quaking aspen, Ilex glabra

Herbaceous (100%): mixed grasses (Phalaris arundinacea\*, panic grass, Leersia spp.), mixed asters, beggartick (Bidens spp.), cinnamon fern, Polygonum spp., mixed goldenrods (Solidago spp.), lupine, jewelweed, clover

Toe: None

rock toe

\* Dominant species in each vegetative strata is marked with an \*

The dominant vegetative strata is the tallest strata with >30% cover

## Adjacent Land Use:

Restored & Agricultural

## Sensitive Receptor:

No

## Notes:

Previously restored site (Kendall), with angular rip-rap stone exposed at toe.

Large patch of rooted submerged aquatic veg in LUW in front of study site

Very steep bank

Agricultural field (row crop – cow corn) at top of bank

Diverse vegetative community from restoration (includes I. glabra and lupine)

2014 Connecticut River Detailed Site Assessments  
Land-Based Survey Photographs Reference No. 815 - 820  
Location ID 3R – September 23, 2014



Photo No. 815



Photo 816

**2014 Connecticut River Detailed Site Assessments  
Land-Based Survey Photographs Reference No. 815 - 820  
Location ID 3R – September 23, 2014**



Photo No. 817



Photo No. 818



**2014 Connecticut River Detailed Site Assessments  
Land-Based Survey Photographs Reference No. 815 - 820  
Location ID 3R – September 23, 2014**



Photo No. 819



Photo No. 820

# Connecticut River – Turners Falls Impoundment Riverbank Detailed Site Assessments

Location ID: 4L

Personnel: YKC, CM, RKS

Date: September 23, 2014

Time: 2:45 PM

Photo Reference Numbers: 821 - 824

Station Number: 737 + 00

Latitude: 42.71964

Longitude: -72.45590

Left or Right Bank (Looking Downstream): Left

Previously Stabilized? No

## Geologic / Geotechnical Observations:

### Stratigraphy:

(Refer to Site Sketch below for locations of soil/rock layers)

Notations in parentheses are based on Unified Soil Classification System)

Upper Bank: SILT (ML) – Low plasticity, <10% fine sand, brown.

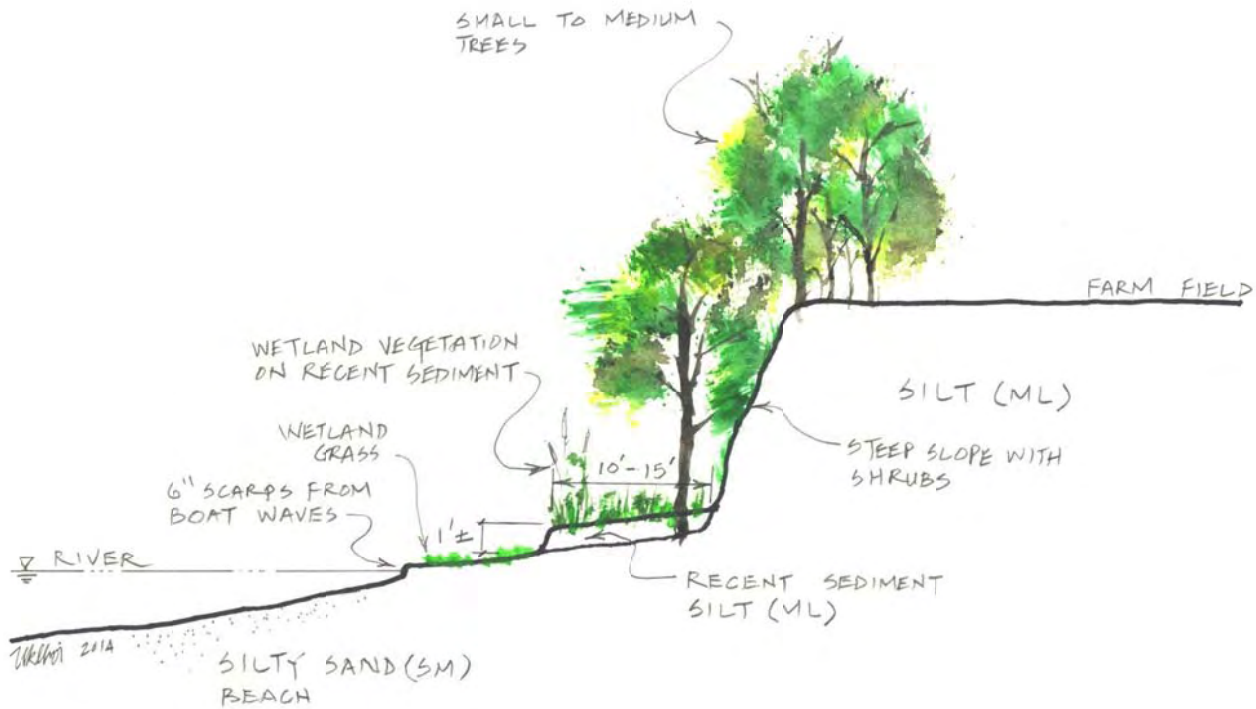
Lower Bank: SILTY SAND (SM) – Mostly fine sand, approx. 10% - 15% low-plasticity fines, gray.

Recent Sediment: SILT (ML) – Slightly plastic, <10% fine sand, mottled brown and orange, organic.

## Observed Erosion Features:

- Steep slope, entire Upper Bank.
- Minor erosion of recent sediment where there was no wetland vegetation.
- 6-inch deep erosion scarp at river level from boat waves.

## Site Sketch:



SECTION - LOCATION ID 4L  
NOT TO SCALE

# Connecticut River – Turners Falls Impoundment Riverbank Classification for Land Based Survey

Observation Point Number: 4L      Date: September 23, 2014

Station Number: 737+00

## Bank Vegetation:

### Top: Heavy (>50%) cover – Broad leaved deciduous tree

Tree (60%): silver maple\*, red maple, elm, ash, black locust, cottonwood, basswood

Shrub (60%): elm\*, multiflora rose, ash saplings, autumn olive, black birch, glossy buckthorn

Vine (65%): bittersweet

Herb (60%): mixed grasses, poison ivy, jewelweed, nightshade, mixed asters & Solidago spp.

### Face: Moderate (>50%) cover – Broad leaved deciduous shrub/vine

Tree (15%): silver maple\*, elm, red maple, cottonwood

Shrub (40%): elm\*, silver maple sapling, red maple sapling, cottonwood sapling, multiflora rose

Vine (65%): bittersweet, some Virginia creeper

Herbaceous (75%): mixed grasses (Phalaris arundinacea\*, Leersia spp.), poison ivy, woolgrass, boneset, Polygonum spp., sedges (inc. Carex spp.), rushes (inc. Eleocharis spp., Juncus effuses,) beggartick (Bidens spp.), purple loosestrife

### Toe: Heavy (>50%) cover – Narrow leaved persistent emergent

Tree (5%): silver maple\*, red maple, elm

Shrub/vine (10%): loosestrife, cottonwood seedlings, red maple seedlings

Herbaceous (85%): woolgrass\*, umbrella sedge, Eleocharis spp., cattails, Scirpus pungens, Phalaris arundinacea, Juncus spp., Leersia spp., loosestrife, Penthorum sedoides

\* Dominant species in each vegetative strata is marked with an \*

The dominant vegetative strata is the tallest strata with >30% cover

## Adjacent Land Use:

Very thin riparian buffer with Agricultural (row crop: corn & sunflower) at top of the bank

## Sensitive Receptor:

No

## Notes:

Very open & sunny

Persistent & Non-persistent Emergent vegetation growing on recently deposited sediment (silt)

Largest patch of Eleocharis we've documented

Invasives inc. bittersweet, buckthorn, autumn olive, loosestrife, and multiflora rose

2014 Connecticut River Detailed Site Assessments  
Land-Based Survey Photographs Reference No. 821 - 824  
Location ID 4L – September 23, 2014



Photo No. 821



Photo 822

2014 Connecticut River Detailed Site Assessments  
Land-Based Survey Photographs Reference No. 821 - 824  
Location ID 4L – September 23, 2014



Photo No. 823



Photo 824

# Connecticut River – Turners Falls Impoundment Riverbank Detailed Site Assessments

Location ID: 4AL

Personnel: YKC, CM, RKS

Date: September 23, 2014

Time: 3:10 PM

Photo Reference Numbers: 825 - 830

Station Number: 738 + 00

Latitude: 42.71993

Longitude: -72.45606

Left or Right Bank (Looking Downstream): Left

Previously Stabilized? No

## Geologic / Geotechnical Observations:

### Stratigraphy:

(Refer to Site Sketch below for locations of soil/rock layers)

Notations in parentheses are based on Unified Soil Classification System)

Upper Bank: SILT (ML) – Low plasticity, <10% fine sand, brown.

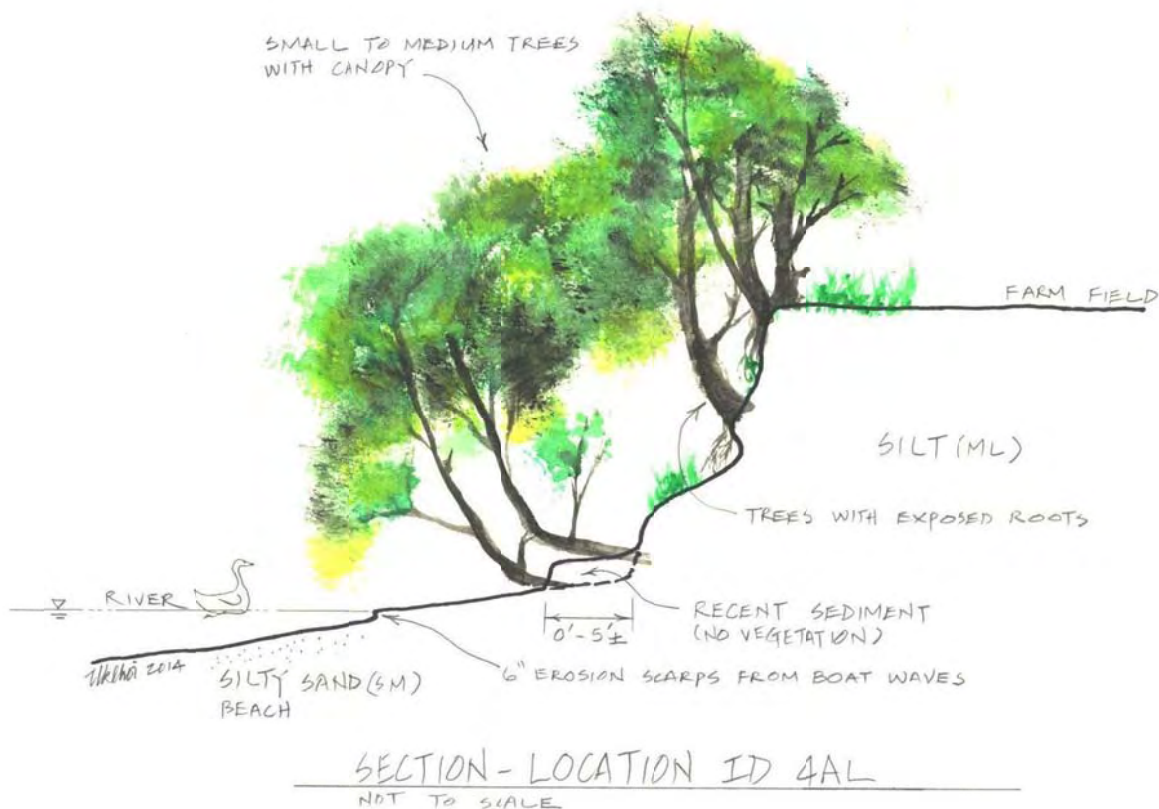
Lower Bank: SILTY SAND (SM) – Mostly fine sand, approx. 10% - 15% low-plasticity fines, gray.

Recent Sediment: SILT (ML) – Slightly plastic, <10% fine sand, mottled brown and orange, organic.

## Observed Erosion Features:

- Steep slope, entire Upper Bank.
- Leaning trees and undercuts at toe of Upper Bank, some with exposed roots
- Overhangs with exposed roots near top of Upper Bank
- Significantly less recent sediment compared with Site 4L which is just 100 feet away. Little to no wetland vegetation on recent sediment.
- 6-inch deep erosion scarp at river level from boat waves

## Site Sketch:



# Connecticut River – Turners Falls Impoundment Riverbank Classification for Land Based Survey

Observation Point Number: 4L      Date: September 23, 2014

Station Number: 738+00

## Bank Vegetation:

Top: Heavy (>50%) cover – Broad leaved deciduous tree

Tree (90%): silver maple\*, elm, green ash

Shrub (60%): silver maple\*, elm, sumac

Vine (70%): bittersweet

Herb (60%): mixed grasses, poison ivy

Face: Heavy (>50%) cover – Broad leaved deciduous tree

Tree (65%): silver maple\*, elm, green ash

Shrub: silver maple\*, elm, ash

Vine (65%): bittersweet, some Virginia creeper

Herbaceous (5%): mixed grasses, poison ivy

Toe: none

bare ground

\* Dominant species in each vegetative strata is marked with an \*

The dominant vegetative strata is the tallest strata with >30% cover

## Adjacent Land Use:

Very thin riparian buffer with Agricultural (row crop: corn & sunflower) at top of the bank

## Sensitive Receptor:

No

## Notes:

Heavily shaded site (with large mature silver maples), located approx. 100' upstream & 100' downstream from more open site, each with a non-persistent/persistent emergent shelf (one of these, the area ~100' downstream, is Site 4L)

Significant bittersweet invasion here

Exposed roots on bank face

**2014 Connecticut River Detailed Site Assessments  
Land-Based Survey Photographs Reference No. 825 - 830  
Location ID 4AL – September 23, 2014**



Photo No. 825



Photo 826



**2014 Connecticut River Detailed Site Assessments  
Land-Based Survey Photographs Reference No. 825 - 830  
Location ID 4AL – September 23, 2014**



Photo No. 827



Photo 828

**2014 Connecticut River Detailed Site Assessments  
Land-Based Survey Photographs Reference No. 825 - 830  
Location ID 4AL – September 23, 2014**



Photo 829

2014 Connecticut River Detailed Site Assessments  
Land-Based Survey Photographs Reference No. 825 - 830  
Location ID 4AL – September 23, 2014



Photo 830

# Connecticut River – Turners Falls Impoundment Riverbank Detailed Site Assessments

Location ID: 5CR

Personnel: YKC, CM, RKS

Date: September 23, 2014

Time: 4:10 PM

Photo Reference Numbers: 831 - 835

Station Number: 572+50

Latitude: 42.68102

Longitude: -72.47197

Left or Right Bank (Looking Downstream): Right

Previously Stabilized? No

## Geologic / Geotechnical Observations:

### Stratigraphy:

(Refer to Site Sketch below for locations of soil/rock layers)

Notations in parentheses are based on Unified Soil Classification System)

Upper Bank: SILT (ML) – Low plasticity, approx. 10% - 20% fine sand, gray.

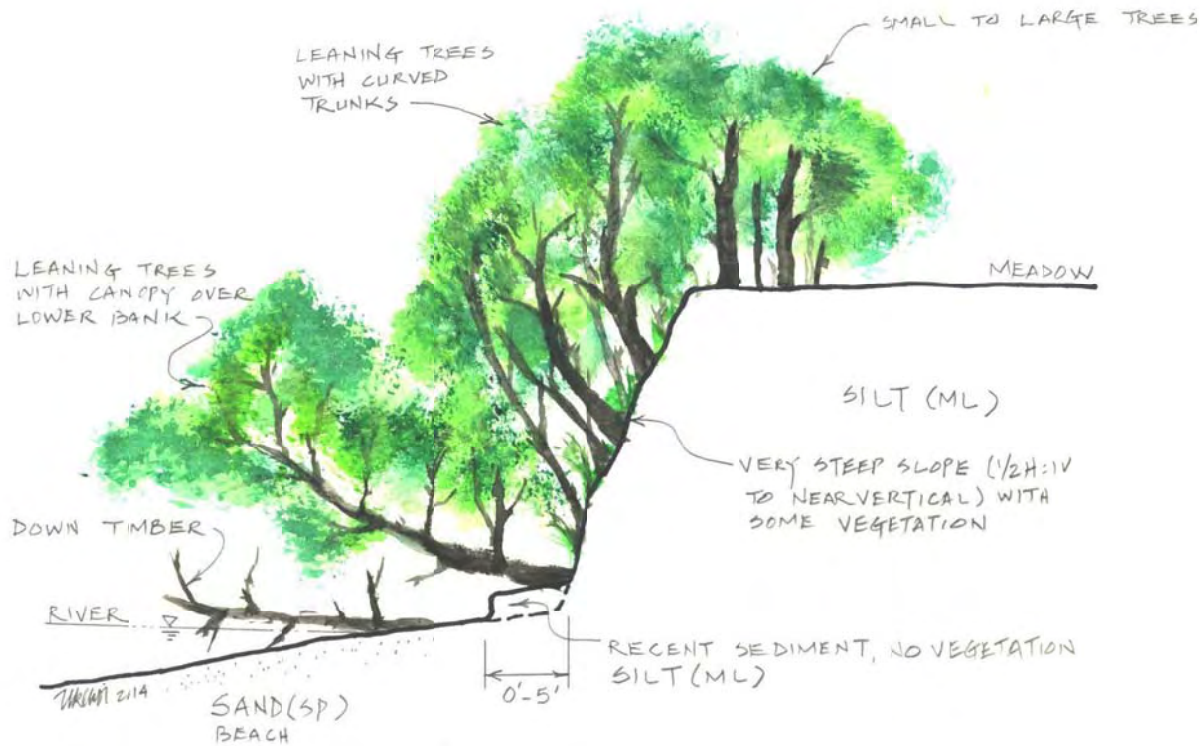
Lower Bank: SAND (SP) – Fine to medium sand, <5% low-plasticity fines, brown.

Recent Sediment: SILT (ML) – Slightly plastic, <10% fine sand, brown.

## Observed Erosion Features:

- Leaning trees, some with curved trunks, with exposed roots.
- Very steep slope, entire Upper Bank.
- Minor undercuts
- Recent sediment with no vegetation

## Site Sketch:



SECTION - LOCATION ID 5CR  
NOT TO SCALE

# Connecticut River – Turners Falls Impoundment Riverbank Classification for Land Based Survey

Observation Point Number: 5CR      Date: September 23, 2014

Station Number:      572+50

## Bank Vegetation:

Top: Heavy (>50%) cover – Broad leaved deciduous tree

Tree (60%): silver maple\*, elm, ash, black locust, basswood, cottonwood, red maple, sugar maple

Shrub: elm\*, alder, multiflora rose, ash saplings

Vine (50%): bittersweet, some grape

Herb (5%): mixed grasses, poison ivy

Face: Moderate (>50%) cover – Broad leaved deciduous tree

Tree (50%): black locust\*, ash, basswood

Shrub: black locust\*, alder, ash, basswood, elm, blueberry, sugar maple saplings

Vine: bittersweet, grape

Herbaceous (15%): mixed grasses (Calamagrostis canadensis\*), NY fern, rushes (inc. Juncus effusus), sedges (inc. Carex spp.), beggartick (Bidens spp.), meadow rue, mixed goldenrods (Solidago spp.)

Toe: Sparse (1%) cover – Narrow-leaved persistent emergent

Tree: cottonwood seedlings

Herbaceous: mixed grasses (Calamagrostis canadensis\*, Phalaris arundinacea, Leersia spp.)

\* Dominant species in each vegetative strata is marked with an \*

The dominant vegetative strata is the tallest strata with >30% cover

## Adjacent Land Use:

Very thin riparian buffer with Agricultural at top of the bank

## Sensitive Receptor:

No

## Notes:

Very steep, near vertical, bank with overhangs & exposed roots

Adjacent to Bennett Meadows agricultural & recreational area

Invasive species, particularly bittersweet

2014 Connecticut River Detailed Site Assessments  
Land-Based Survey Photographs Reference No. 831 - 835  
Location ID 5CR – September 23, 2014



Photo No. 831



Photo 832

2014 Connecticut River Detailed Site Assessments  
Land-Based Survey Photographs Reference No. 831 - 835  
Location ID 5CR – September 23, 2014



Photo No. 833



Photo 834

**2014 Connecticut River Detailed Site Assessments  
Land-Based Survey Photographs Reference No. 831 - 835  
Location ID 5CR – September 23, 2014**



Photo 835



# Connecticut River – Turners Falls Impoundment Riverbank Detailed Site Assessments

Location ID: 10L

Personnel: YKC, CM, RKS

Date: September 24, 2014

Time: 12:15 PM

Photo Reference Numbers: 855 - 858

Station Number: 490+00

Latitude: 42.66099

Longitude: -72.46698

Left or Right Bank (Looking Downstream): Left

Previously Stabilized? No

## Geologic / Geotechnical Observations:

### Stratigraphy:

(Refer to Site Sketch below for locations of soil/rock layers)

Notations in parentheses are based on Unified Soil Classification System)

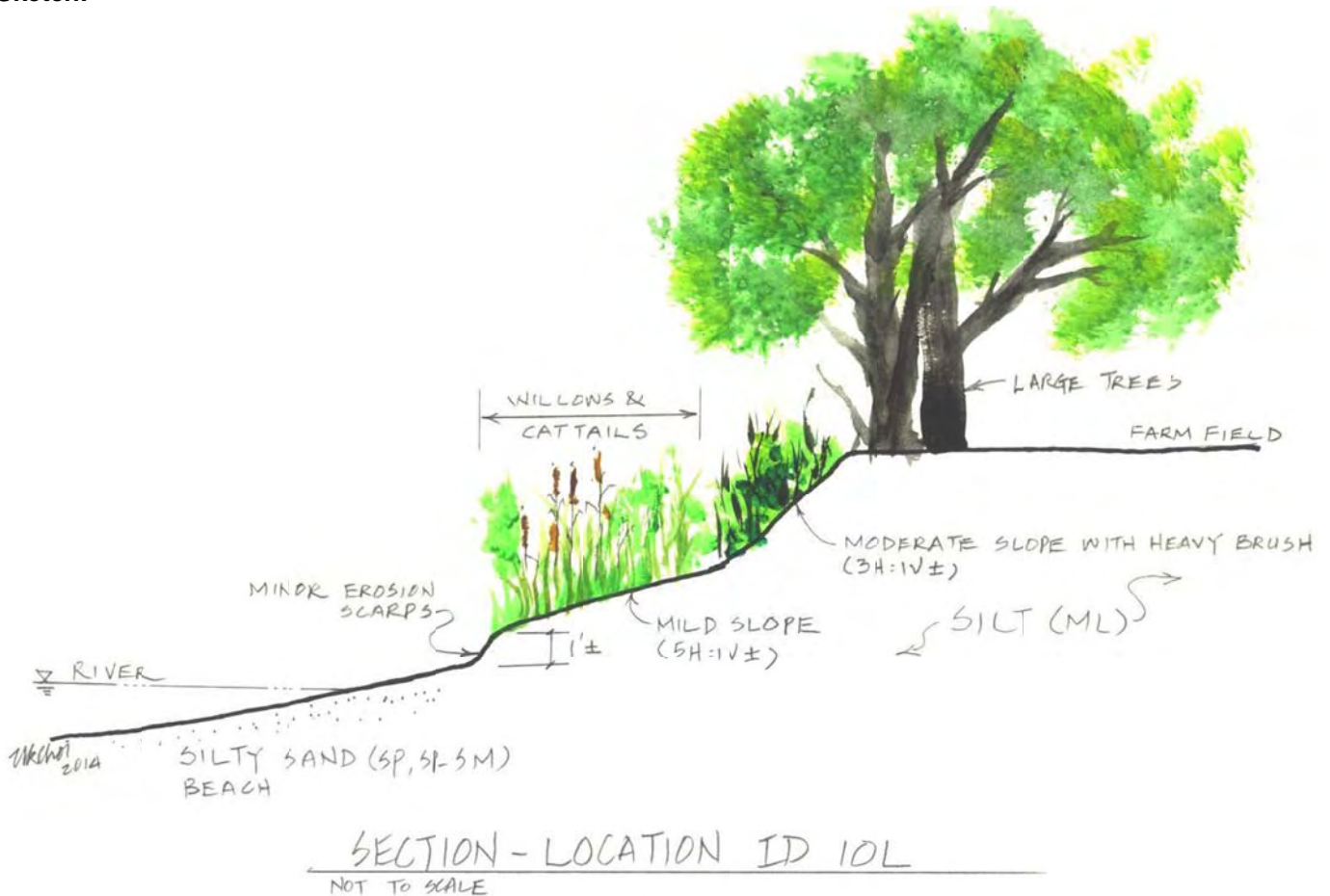
Upper Bank: SILT (ML) – Low plasticity, <10% fine sand, gray.

Lower Bank: SAND (SP, SP-SM) – Fine sand, approx. 5% - 10% low-plasticity fines, gray.

## Observed Erosion Features:

- Little to no erosion.
- Minor erosion scarps at the toe of Upper Bank where there was no wetland vegetation.

## Site Sketch:



# Connecticut River – Turners Falls Impoundment Riverbank Classification for Land Based Survey

Observation Point Number: 10L      Date: September 24, 2014

Station Number:      490+00

## Bank Vegetation:

Top: Moderate (25-50%) cover – Broad leaved deciduous tree

Tree (45%): silver maple\*, ash, weeping willow, red maple

Shrub (70%): red maple sapling\*, alder, elm

Vine: bittersweet

Herbaceous (15%): Jerusalem artichoke, jewelweed, poison ivy, mint, mixed upland grasses

Face: Moderate (25-50%) cover – Broad leaved deciduous tall shrub/sapling

Tree (15%): red maple\*, silver maple, weeping willow

Shrub (35%): willow\*, purple loosestrife, red maple sapling, elm

Herbaceous (15%): cattail\*, umbrella sedge, 3-way sedge, Phalaris arundinacea, woolgrass, jewelweed, Eleocharis spp., Bidens, mixed unidentified grasses, mixed Solidago spp.

Toe: sparse (<10%) cover – robust persistent emergent

Tree (0%):

Shrub (<1%): purple loosestrife\*, willow

Herbaceous (<10%): cattail\*, sedges and rushes (inc. umbrella sedge, 3-way sedge, Carex spp., Juncus effusus, Juncus canadensis, woolgrass, Eleocharis spp.)

\* Dominant species in each vegetative strata is marked with an \*

The dominant vegetative strata is the tallest strata with >30% cover

## Adjacent Land Use:

Agricultural (row crop – corn) with very thin riparian buffer ~1 tree width

## Sensitive Receptor:

No

## Notes:

There is a willow bench with some loosestrife mixed in

Very thin riparian buffer (~1 tree width) along row crop (corn) field edge

Invasive species present including purple loosestrife, multiflora rose, bittersweet, and garden escapees

**2014 Connecticut River Detailed Site Assessments  
Land-Based Survey Photographs Reference No. 855 - 858  
Location ID 10L – September 24, 2014**



Photo No. 855



Photo 856

**2014 Connecticut River Detailed Site Assessments  
Land-Based Survey Photographs Reference No. 855 - 858  
Location ID 10L – September 24, 2014**



Photo No. 857



Photo 858

# Connecticut River – Turners Falls Impoundment Riverbank Classification for Land Based Survey

**Observation Point Number:** 10R      **Date:** September 24, 2014

**Station Number:** 490+00

## Bank Vegetation:

Top: Heavy (>50%) cover – Broad leaved deciduous tall shrub/sapling

Tree (5%): pin oak\*, cottonwood, red oak, hickory, silver maple, red maple

Shrub (80%): staghorn sumac, winged euonymus, black locust sapling, quaking aspen, white oak sapling, raspberry, honeysuckle

Vine: creeper\*, bittersweet

Herbaceous (45%): mixed upland grasses, mixed Solidago spp., mixed asters

Face: Heavy (>50%) cover – Broad leaved deciduous tall shrub/sapling

Tree (1%): pin oak\*, cottonwood

Shrub (70%): sumac\*, alder, honeysuckle, multiflora rose, dogwoods, raspberry, red maple saplings, willow

Herbaceous (15%): mixed grasses (inc. Calamagrostis\*, Phalaris arundinacea), mixed asters, mixed goldenrods (Solidago spp.)

Toe: none

Bare rock

\* Dominant species in each vegetative strata is marked with an \*

The dominant vegetative strata is the tallest strata with >30% cover

## Adjacent Land Use:

Forested further back from restoration site, & Agricultural (row crop – cow corn)

## Sensitive Receptor:

No

## Notes:

Restoration Site (Urgiel Upstream), with 2-6" angular riprap rock at toe and no erosion at toe

Some slumping above rock toe, mid-slope and near the top of the slope of the upper bank

The "Fuzzy Tree" site – there is a single stand-out tree at the top of the bank engulfed in Virginia creeper, which makes this site distinguishable to many. The creeper is red in the fall.

Site is mostly vegetated with sumac at the top of the bank

Lots of invasives here, inc: bittersweet, creeper, honeysuckle, winged euonymus, and multiflora rose

# Connecticut River – Turners Falls Impoundment Riverbank Detailed Site Assessments

Location ID: 10R

Personnel: YKC, CM, RKS

Date: September 24, 2014

Time: 11:30 AM

Photo Reference Numbers: 850 - 854

Station Number: 490+00

Latitude: 42.65999

Longitude: -72.46927

Left or Right Bank (Looking Downstream): Right

Previously Stabilized? Yes (Urgiel Upstream, 2001)

## Geologic / Geotechnical Observations:

### Stratigraphy:

(Refer to Site Sketch below for locations of soil/rock layers)

Notations in parentheses are based on Unified Soil Classification System)

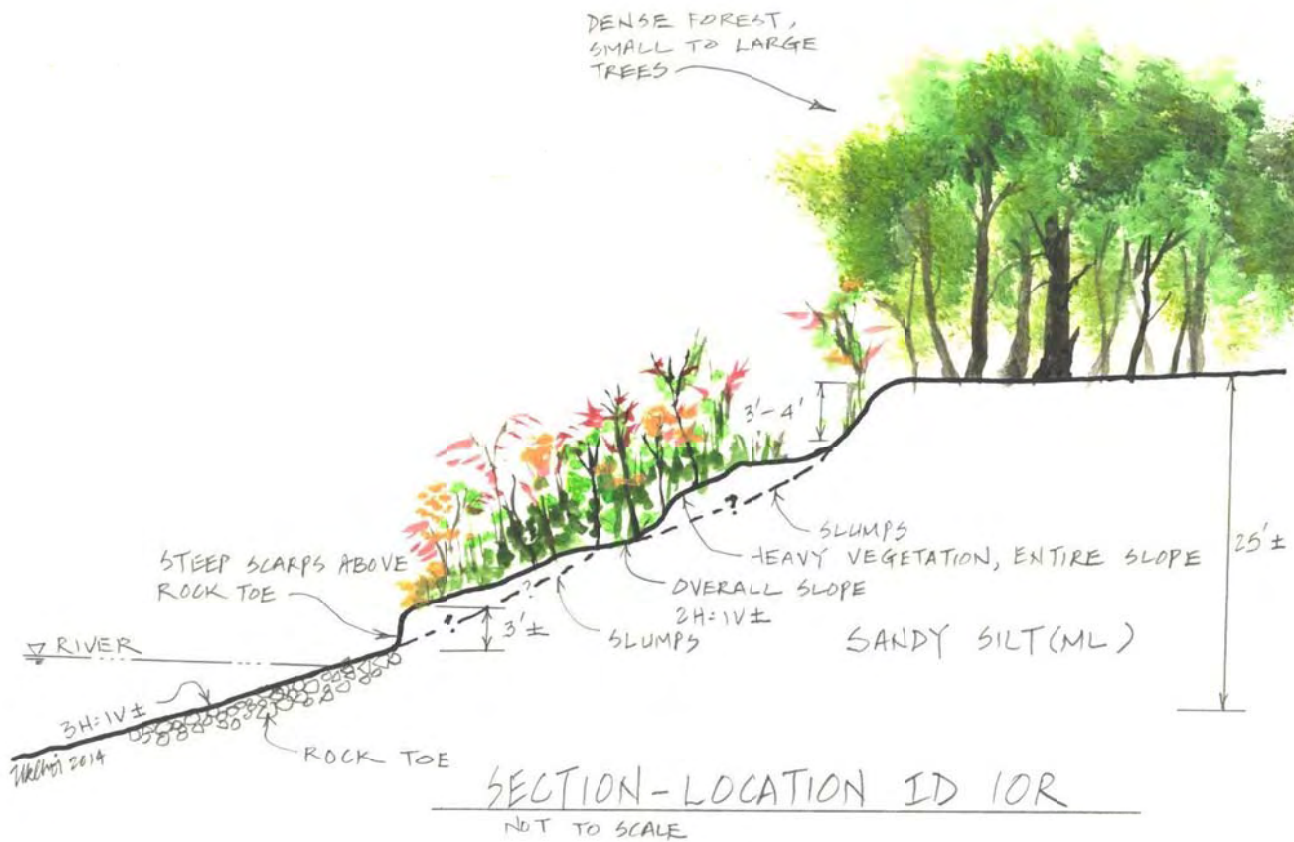
SANDY SILT (ML) – Low plasticity, approx. 30% - 40% fine sand, brown.

Rock Toe – 2" to 6" riprap rock, angular, hard, little deterioration.

## Observed Erosion Features:

- Little erosion at rock toe, with no depressions or movements observed.
- Some slumping above rock toe, mid-slope, and near the top of slope of Upper Bank.

## Site Sketch:



**2014 Connecticut River Detailed Site Assessments  
Land-Based Survey Photographs Reference No. 850 - 854  
Location ID 10R – September 24, 2014**



Photo No. 850



Photo No. 851

2014 Connecticut River Detailed Site Assessments  
Land-Based Survey Photographs Reference No. 850 - 854  
Location ID 10R – September 24, 2014



Photo No. 852



**2014 Connecticut River Detailed Site Assessments  
Land-Based Survey Photographs Reference No. 850 - 854  
Location ID 10R – September 24, 2014**



Photo No. 853

**2014 Connecticut River Detailed Site Assessments  
Land-Based Survey Photographs Reference No. 850 - 854  
Location ID 10R – September 24, 2014**



Photo No. 854

# Connecticut River – Turners Falls Impoundment Riverbank Detailed Site Assessments

Location ID: 6AL

Personnel: YKC, CM, RKS

Date: September 24, 2014

Time: 1:00 PM

Photo Reference Numbers: 859 - 864

Station Number: 417+50

Latitude: 42.64249

Longitude: -72.47578

Left or Right Bank (Looking Downstream): Left

Previously Stabilized? Yes (Skalaski, 2004)

## Geologic / Geotechnical Observations:

### Stratigraphy:

(Refer to Site Sketch below for locations of soil/rock layers)

Notations in parentheses are based on Unified Soil Classification System)

Upper Bank, Upper Layer: SILTY SAND (SM) – Fine to coarse sand, approx. 20% - 30% nonplastic fines, brown.

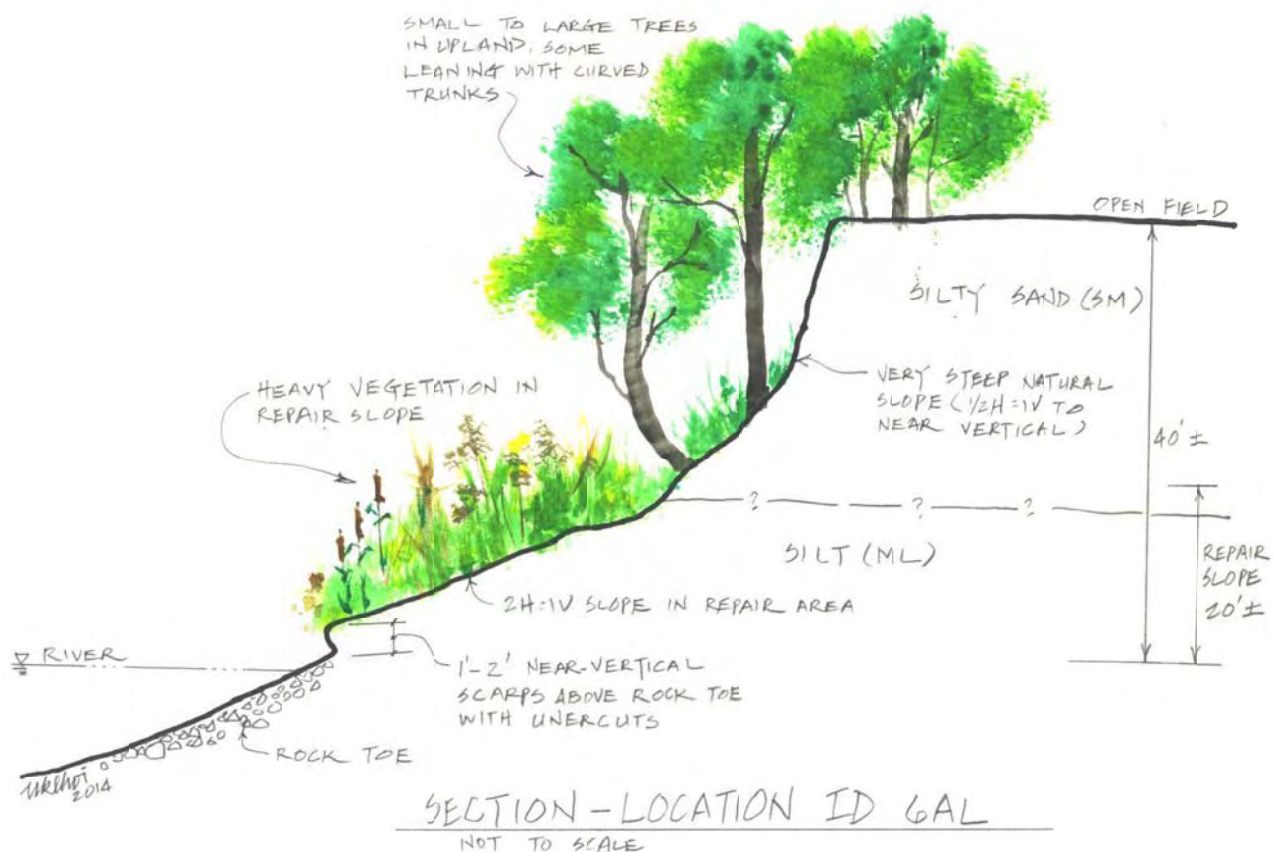
Upper Bank, Lower Layer: SILT (ML) – Slightly plastic, approx. 15% - 20% fine sand, gray.

Rock Toe – 1" to 4" riprap rock, angular, hard, minor deterioration.

## Observed Erosion Features:

- Little erosion at rock toe, with no depressions or movements observed.
- 1' – 2' high near-vertical scarps just above the rock toe, with minor undercuts.
- Very steep natural upland slope above repaired area.
- Some leaning trees in natural upland slope, some with curved trunks.

## Site Sketch:



# Connecticut River – Turners Falls Impoundment Riverbank Classification for Land Based Survey

Observation Point Number: 6AL      Date: September 24, 2014

Station Number: 417+50

## Bank Vegetation:

### Top: Heavy (>50%) cover – Broad leaved deciduous tree

Tree (60%): sugar maple\*, red oak, white oak, sycamore, eastern white pine, hemlock, black birch, white birch

Shrub: hemlock\*, red maple, sycamore, gray birch, sumac

Vine: bittersweet\*, some Virginia creeper

Herbaceous: Christmas fern, hay scented fern, jewelweed

### Face: Heavy (>50%) cover – Broad leaved deciduous shrub/sapling

Tree (15%): sycamore\*, sugar maple, red maple, hemlock, black birch, gray birch

Shrub (90%): sumac\*, hemlock, red maple, willow, sugar maple, sycamore, Viburnum, dogwoods

Vine: bittersweet\*, some creeper

Herbaceous (15%): cinnamon fern, Christmas fern, asters, jewelweed, ostrich fern, mixed goldenrods (Solidago spp.), Japanese knotweed (including within the restoration area), horsetail (Equisetum spp.), woolgrass

### Toe: Sparse (1%) cover – Robust persistent emergent

Mostly rock, with sparse cattails

\* Dominant species in each vegetative strata is marked with an \*

The dominant vegetative strata is the tallest strata with >30% cover

## Adjacent Land Use:

Agricultural (potato field) at top of the bank

## Sensitive Receptor:

Yes – Kingfisher nest cavity

## Notes:

Very steep

Skalaski restoration site with rock toe

Invasive species, particularly bittersweet but some Japanese knotweed, even within the restoration footprint (total knotweed aerial coverage <5%)

**2014 Connecticut River Detailed Site Assessments  
Land-Based Survey Photographs Reference No. 859 - 864  
Location ID 6AL – September 24, 2014**



Photo No. 859



Photo No. 860

**2014 Connecticut River Detailed Site Assessments  
Land-Based Survey Photographs Reference No. 859 - 864  
Location ID 6AL – September 24, 2014**



Photo No. 861

**2014 Connecticut River Detailed Site Assessments  
Land-Based Survey Photographs Reference No. 859 - 864  
Location ID 6AL – September 24, 2014**



Photo No. 862

**2014 Connecticut River Detailed Site Assessments  
Land-Based Survey Photographs Reference No. 859 - 864  
Location ID 6AL – September 24, 2014**



Photo No. 863



Photo No. 864



# Connecticut River – Turners Falls Impoundment Riverbank Detailed Site Assessments

Location ID: 7L

Personnel: YKC, CM, RKS

Date: September 25, 2014

Time: 8:00 AM

Photo Reference Numbers: 871 - 877

Station Number: 375+00

Latitude: 42.63684

Longitude: -72.48664

Left or Right Bank (Looking Downstream): Left

Previously Stabilized? No

## Geologic / Geotechnical Observations:

### Stratigraphy:

(Refer to Site Sketch below for locations of soil/rock layers)

Notations in parentheses are based on Unified Soil Classification System)

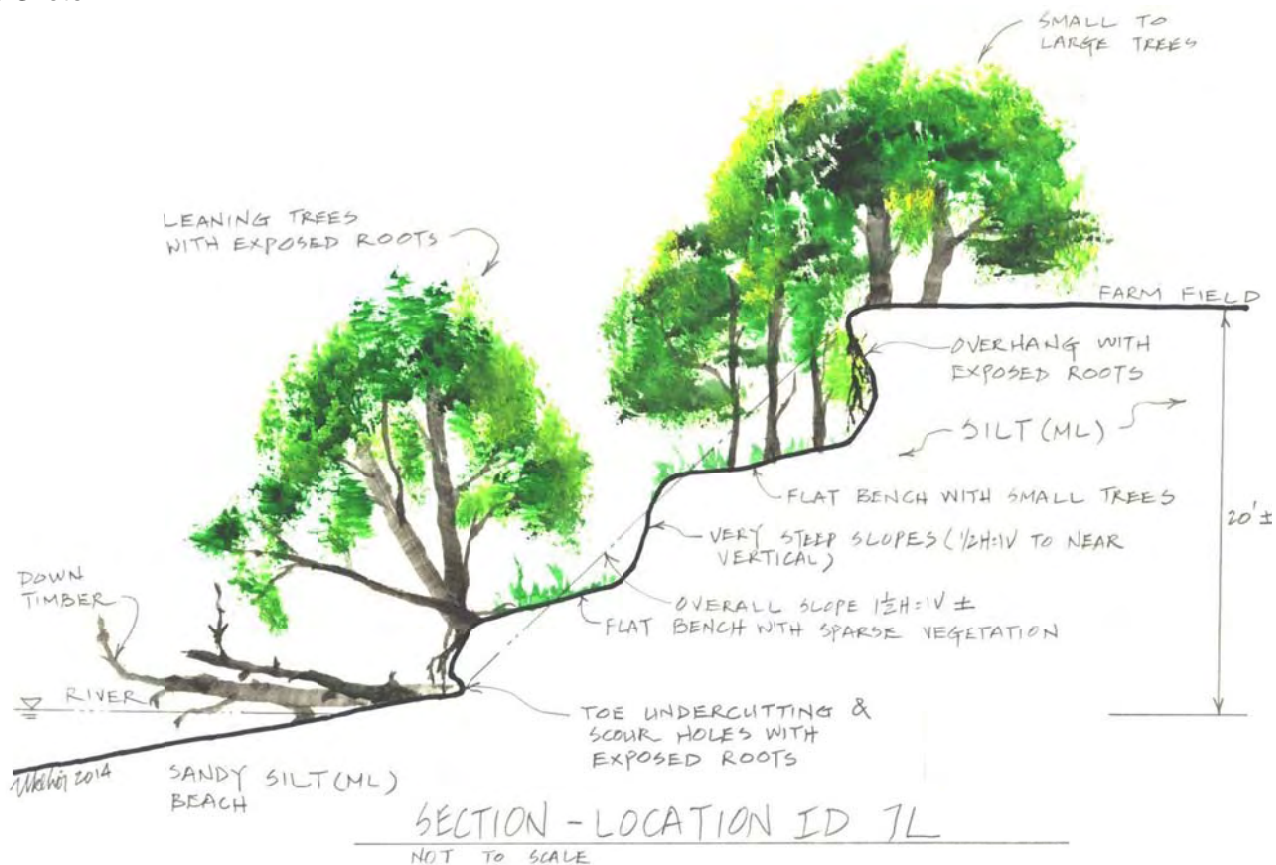
Upper Bank: SILT (ML) – Low plasticity, approx. 10% - 20% fine sand, gray.

Lower Bank: SANDY SILT (ML) – Low plasticity, approx. 40% to 50% fine sand, gray.

## Observed Erosion Features:

- Very steep slopes near top of Upper Bank, with little vegetation.
- Leaning trees with exposed roots at river level.
- Mass wasting with slumping and exposed roots.
- Toe undercutting and localized scour holes between trees at river level.
- Overhangs with exposed roots of large trees at top of Upper Bank.

## Site Sketch:



# Connecticut River – Turners Falls Impoundment Riverbank Classification for Land Based Survey

Observation Point Number: 7L      Date: September 25, 2014

Station Number: 375+00

## Bank Vegetation:

### Top: Heavy (>50%) cover – Broad leaved deciduous tree

Tree (60%): red oak\*, white oak, basswood, elm

Shrub (50%): morrow's honeysuckle\*, raspberry, sumac, elm, dogwoods

Vine (40%): bittersweet\*, grape, Virginia creeper

Herbaceous (15%): poison ivy, Solidago spp., mixed grasses & asters

### Face: Heavy (>50%) cover – Broad leaved deciduous tree

Tree (60%): basswood\*, elm, ash, red oak, white oak, cottonwood, ashleaf maple

Shrub (20%): elm\*, red oak sapling, white oak sapling, ash sapling, basswood sapling, barberry, honeysuckle,

Vine (35%): bittersweet\*, Virginia creeper, grape

Herbaceous (<10%): garlic mustard, cinnamon fern, mixed goldenrods (Solidago spp.), mixed asters & mixed grasses

### Toe: sparse (<5%) cover – Broad leaved deciduous (mixed)

Tree (<5%): basswood\*, elm, red oak, white oak (partly fallen, overhanging trees)

Shrub (<10%): honeysuckle\*, basswood sapling, elm

Vine (30%): bittersweet\* with some grape and creeper

Herbaceous: none

\* Dominant species in each vegetative strata is marked with an \*

The dominant vegetative strata is the tallest strata with >30% cover

## Adjacent Land Use:

Very thin riparian buffer (1 tree width) with agricultural land use at the top of the bank

## Sensitive Receptor:

No

## Notes:

Lots of invasive species here: barberry, morrow's honeysuckle, garlic mustard, Virginia creeper, and oriental bittersweet is very prevalent, covering everything

**2014 Connecticut River Detailed Site Assessments  
Land-Based Survey Photographs Reference No. 871 - 877  
Location ID 7L – September 25, 2014**



Photo No. 871



Photo No. 872

**2014 Connecticut River Detailed Site Assessments  
Land-Based Survey Photographs Reference No. 871 - 877  
Location ID 7L – September 25, 2014**



Photo No. 873

**2014 Connecticut River Detailed Site Assessments  
Land-Based Survey Photographs Reference No. 871 - 877  
Location ID 7L – September 25, 2014**



Photo No. 874

2014 Connecticut River Detailed Site Assessments  
Land-Based Survey Photographs Reference No. 871 - 877  
Location ID 7L – September 25, 2014



Photo No. 875

**2014 Connecticut River Detailed Site Assessments  
Land-Based Survey Photographs Reference No. 871 - 877  
Location ID 7L – September 25, 2014**



Photo No. 876



Photo No. 877

# Connecticut River – Turners Falls Impoundment Riverbank Detailed Site Assessments

Location ID: 7R

Personnel: YKC, CM, RKS

Date: September 25, 2014

Time: 9:00 AM

Photo Reference Numbers: 879 - 884

Station Number: 375+00

Latitude: 42.63824

Longitude: -72.49010

Left or Right Bank (Looking Downstream): Right

Previously Stabilized? No

## Geologic / Geotechnical Observations:

### Stratigraphy:

(Refer to Site Sketch below for locations of soil/rock layers)

Notations in parentheses are based on Unified Soil Classification System)

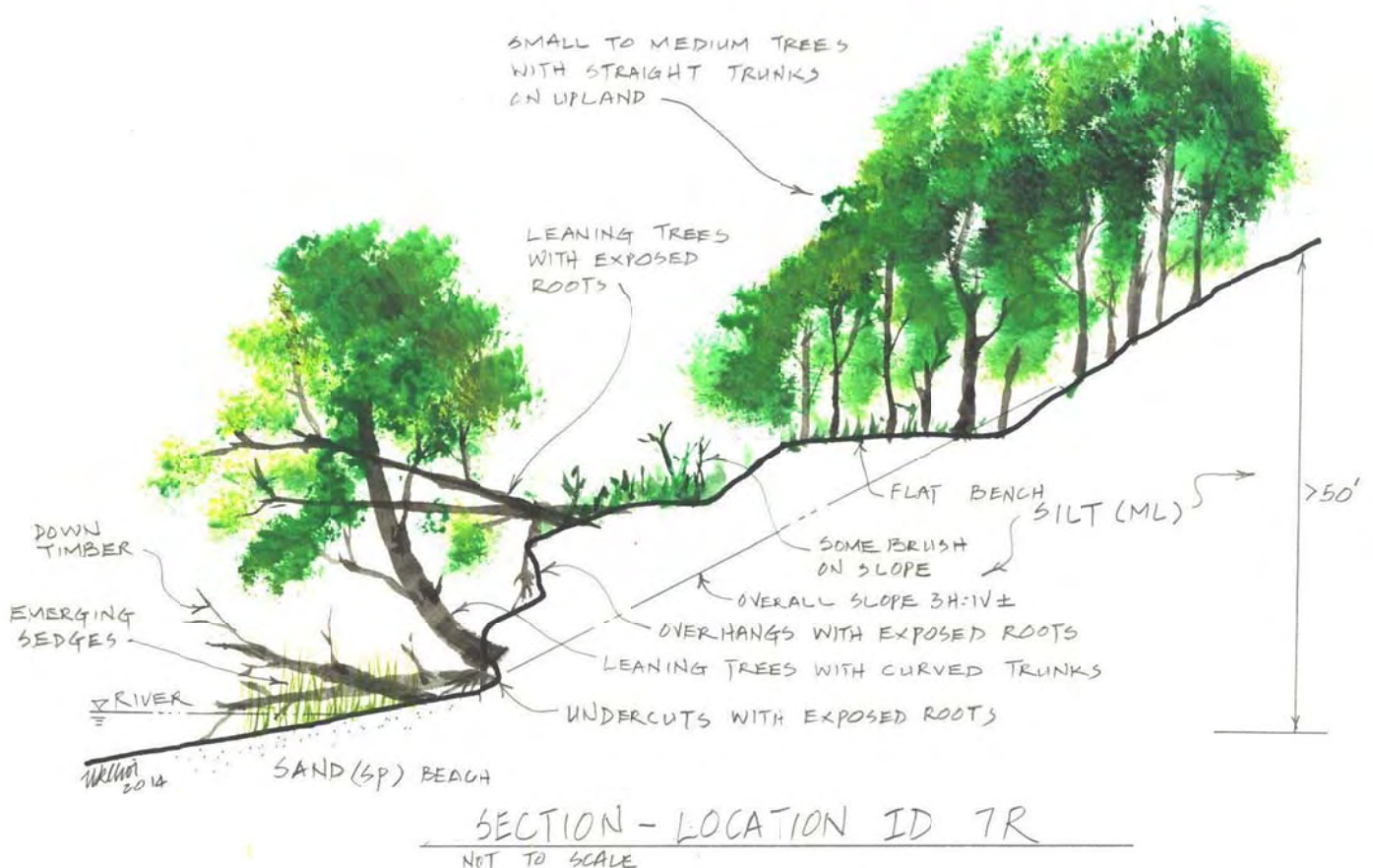
Upper Bank: SILT (ML) – Low plasticity, approx. 20% - 30% fine sand, gray.

Lower Bank: SAND (SP) – Fine to medium sand, <5% nonplastic fines, brown and gray.

## Observed Erosion Features:

- Undercuts with exposed roots at river level.
- Mass-wasting along entire slope.
- Trees on upland area have straight trunks, suggesting the trees post-date the mass-wasting movement.
- Leaning trees with exposed roots at river level and bottom of Upper Bank, some with curved trunks.
- Large scour hole (20' wide x 40' long x 15 feet deep) at mid-slope, with flowing groundwater at bottom of hole.

## Site Sketch:





# Connecticut River – Turners Falls Impoundment Riverbank Classification for Land Based Survey

Observation Point Number: 7R

Date: September 25, 2014

Station Number: 375+00

## Bank Vegetation:

### Top: Heavy (>50%) cover – Broad leaved deciduous tree

Tree (80%): sugar maple\*, eastern white pine, hemlock, black birch, ash, white oak

Shrub (2%): black birch sapling\*, barberry, honeysuckle, sugar maple sapling

Vine (2%): bittersweet\*, grape

Herbaceous (10%): mixed ferns (inc. Christmas fern, ostrich fern, Dryopteris spp., sensitive fern), poison ivy, asters

### Face: Heavy (>50%) cover – Broad leaved deciduous shrub

Tree (40%): black birch\*, sugar maple, eastern white pine, hemlock, ash

Shrub (60%): barberry, honeysuckle, hemlock, ash sapling, sugar maple sapling, poison ivy shrub, white oak sapling

Vine: bittersweet\*, Virginia creeper, grape

Herbaceous (<5%): poison ivy, Christmas fern, asters

### Toe: sparse (<5%) cover – narrow leaved persistent emergent

Tree (10%): ash\*, sugar maple, eastern white pine, red oak, black birch (partly fallen, overhanging trees)

Shrub (<10%): honeysuckle\*

Vine (5%): bittersweet\*, grape

Herbaceous (50%): three square sedge (Scirpus americanus)

\* Dominant species in each vegetative strata is marked with an \*

The dominant vegetative strata is the tallest strata with >30% cover

## Adjacent Land Use:

Forested

## Sensitive Receptor:

No

## Notes:

There is a section on the bench where rock has been placed (see photos)

Approx. 3 m upstream there is a small patch of three square, ~5m x 5m in size (CM photo 50)

There is a gully where a tree fell mid slope up the hill (CM photo 051)

Very high bank

Mid slope is very steep – too steep to support much vegetation

Invasive species are present here, including: Japanese barberry, oriental bittersweet, and honeysuckle. However, none are dominating. The bittersweet is covering everything mid-bank but is absent from the denser forested area at the top of the bank; the barberry is sparse at the top of the bank, ~1%. Honeysuckle is denser at the lower mid slope.

**2014 Connecticut River Detailed Site Assessments  
Land-Based Survey Photographs Reference No. 879 - 884  
Location ID 7R – September 25, 2014**



Photo No. 879



Photo No. 880

2014 Connecticut River Detailed Site Assessments  
Land-Based Survey Photographs Reference No. 879 - 884  
Location ID 7R – September 25, 2014



Photo No. 881



Photo No. 882

2014 Connecticut River Detailed Site Assessments  
Land-Based Survey Photographs Reference No. 879 - 884  
Location ID 7R – September 25, 2014



Photo No. 883



Photo No. 884

# Connecticut River – Turners Falls Impoundment Riverbank Detailed Site Assessments

Location ID: 8BL

Personnel: YKC, CM, RKS

Date: September 25, 2014

Time: 9:50 AM

Photo Reference Numbers: 885 - 891

Station Number: 327+50

Latitude: 42.62466

Longitude: -72.48204

Left or Right Bank (Looking Downstream): Left

Previously Stabilized? No

## Geologic / Geotechnical Observations:

### Stratigraphy:

(Refer to Site Sketch below for locations of soil/rock layers)

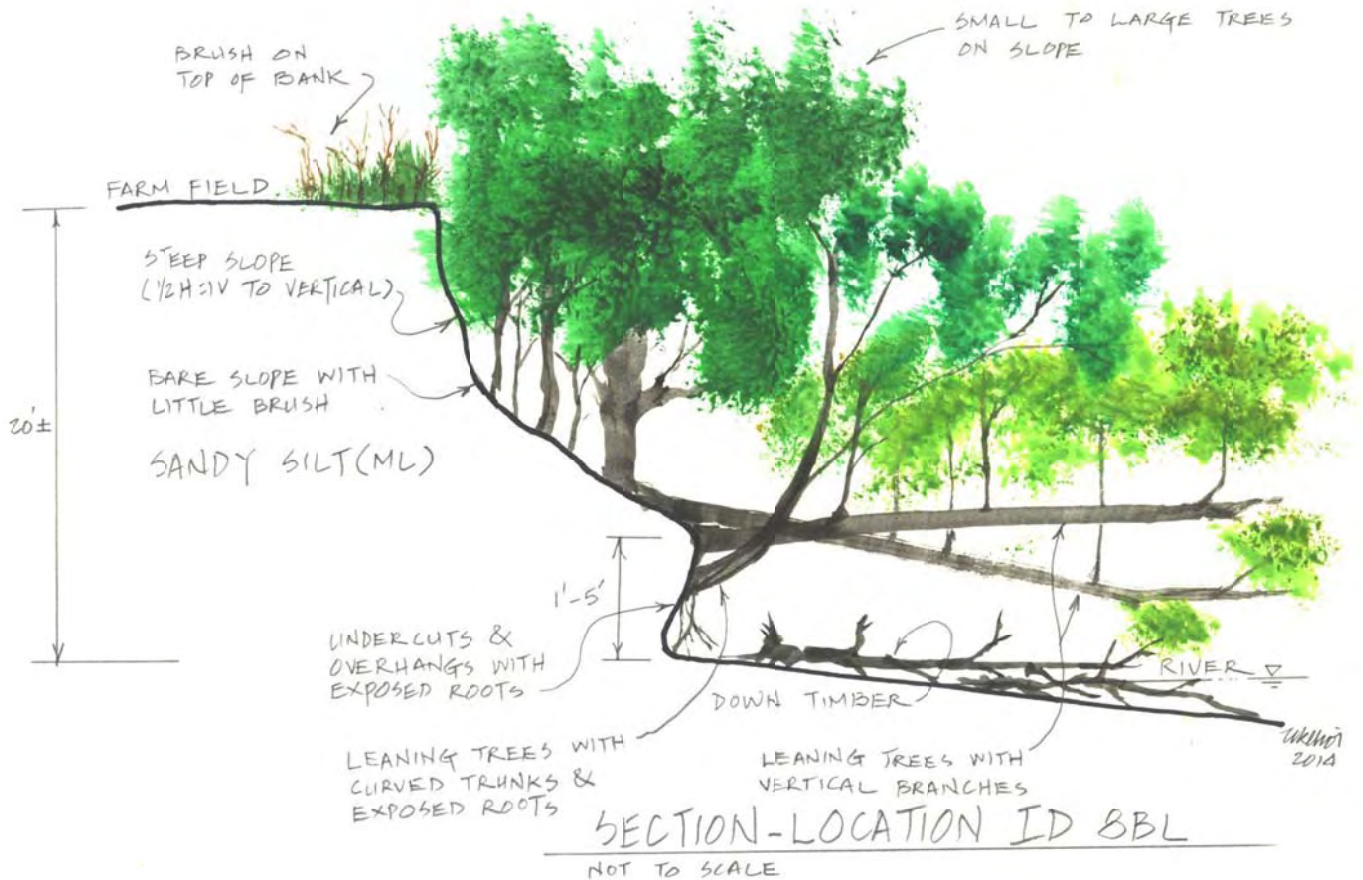
Notations in parentheses are based on Unified Soil Classification System)

SANDY SILT (ML) – Low plasticity, approx. 10% - 20% fine sand, brown.

## Observed Erosion Features:

- Mass-wasting entire slope on Upper Bank.
- Undercuts and overhangs with exposed roots near river level.
- Leaning trees with exposed roots near river level.
- Very steep slope along entire Upper Bank.

## Site Sketch:



# Connecticut River – Turners Falls Impoundment Riverbank Classification for Land Based Survey

Observation Point Number: 8BL      Date: September 25, 2014

Station Number:      327+50

## Bank Vegetation:

Top: Moderate (30%) cover – Broad leaved deciduous shrub/sapling

Tree (20%): red oak\*, basswood, pin oak, ashleaf maple

Shrub (30%): elm\*, black birch saplings, raspberry, Japanese barberry, alder, multiflora rose,

Vine (<5%): Virginia creeper\*, bittersweet

Herbaceous (60%): milkweed, ragweed, asters, clover, mixed grasses (much is mown and forms the edge of the agricultural field)

Face: Heavy (>50%) cover – Broad leaved deciduous tree

Tree (65%): basswood\*, elm, green ash, white oak, red oak

Shrub (5%): multiflora rose\*, barberry, honeysuckle, elm, dogwoods, willow

Vine: Virginia creeper\*, bittersweet

Herbaceous (75%): mixed asters, mixed goldenrods (*Solidago* spp.), garlic mustard, mixed upland grasses

Toe: sparse (1%) cover – narrow leaved persistent emergent

Tree (0%):

Shrub (<1%): sugar maple sapling, green ash sapling (shade from mid-slope)

Herbaceous (1%): *Scirpus* spp.

\* Dominant species in each vegetative strata is marked with an \*

The dominant vegetative strata is the tallest strata with >30% cover

## Adjacent Land Use:

Forested

## Sensitive Receptor:

No

## Notes:

Gravelly beach with some cobbles

Very thin riparian buffer at top where agricultural field edge meets top of bank

Bank is steep with near vertical slope at top, bare slopes where it is too steep to support vegetation, undercuts and overhangs with exposed roots, leaning trees with curved trunks and exposed roots, and downed trees.

**2014 Connecticut River Detailed Site Assessments  
Land-Based Survey Photographs Reference No. 885 - 891  
Location ID 8BL – September 25, 2014**



Photo No. 885



Photo No. 886

**2014 Connecticut River Detailed Site Assessments  
Land-Based Survey Photographs Reference No. 885 - 891  
Location ID 8BL – September 25, 2014**



Photo No. 887



2014 Connecticut River Detailed Site Assessments  
Land-Based Survey Photographs Reference No. 885 - 891  
Location ID 8BL – September 25, 2014



Photo No. 888

**2014 Connecticut River Detailed Site Assessments  
Land-Based Survey Photographs Reference No. 885 - 891  
Location ID 8BL – September 25, 2014**



Photo No. 889



Photo No. 890

**2014 Connecticut River Detailed Site Assessments  
Land-Based Survey Photographs Reference No. 885 - 891  
Location ID 8BL – September 25, 2014**



Photo No. 891

# Connecticut River – Turners Falls Impoundment Riverbank Detailed Site Assessments

Location ID: BC-1R

Personnel: YKC, CM, RKS

Date: September 24, 2014

Time: 7:55 AM

Photo Reference Numbers: 836 - 843

Station Number: 47+50

Latitude: 42.59935

Longitude: -72.54431

Left or Right Bank (Looking Downstream): Right

Previously Stabilized? No

## Geologic / Geotechnical Observations:

### Stratigraphy:

(Refer to Site Sketch below for locations of soil/rock layers)

Notations in parentheses are based on Unified Soil Classification System)

Upper Bank: SAND (SP, SP-SM) – Fine to medium sand, approx. 5% - 10% nonplastic fines, moist, brown.

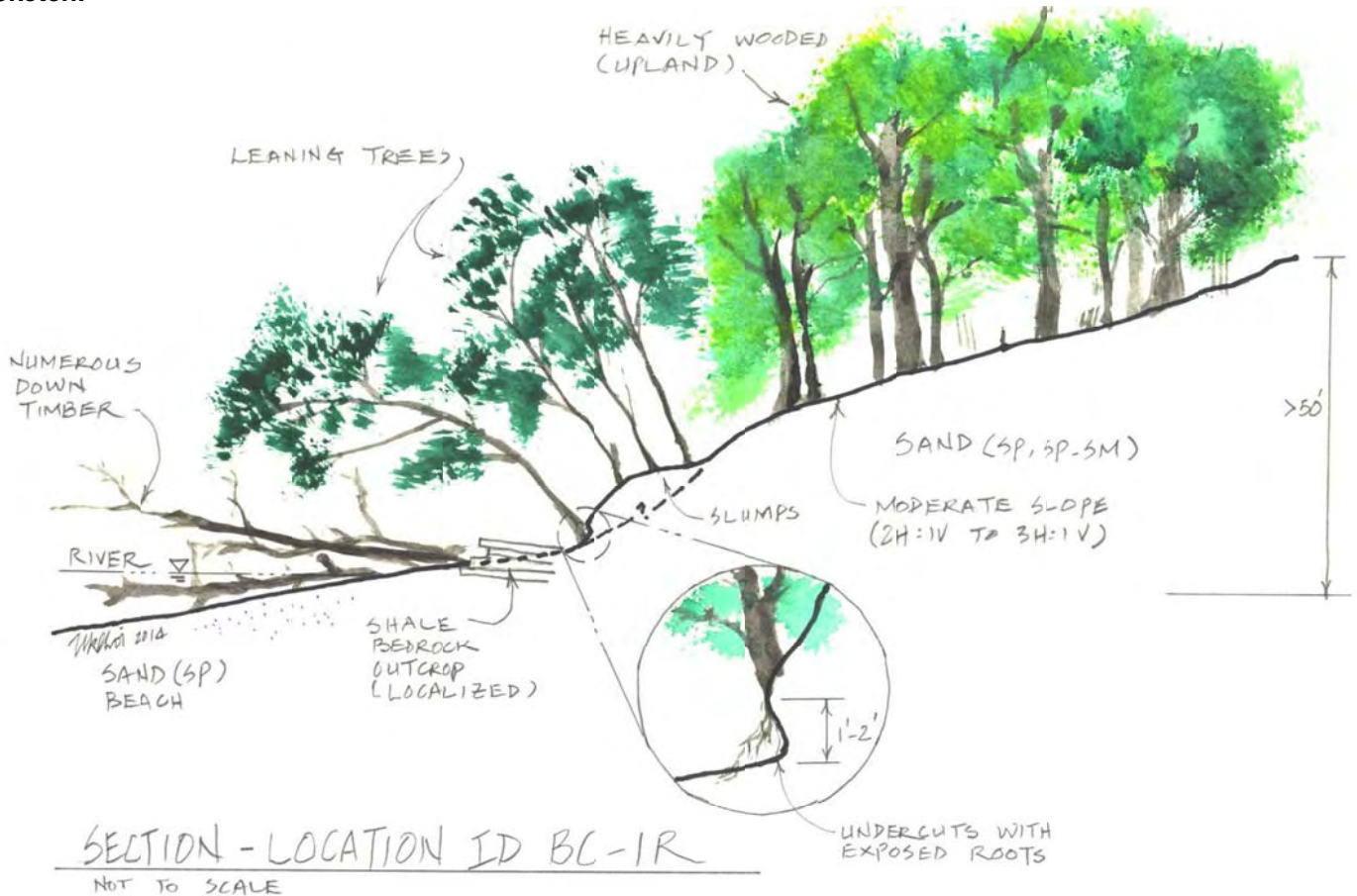
Lower Bank: SAND (SP) – Mostly medium sand, <5% nonplastic fines, some gravel, brown.

BEDROCK – Shale, hard, weathered.

## Observed Erosion Features:

- Undercuts with exposed roots
- Leaning trees, some with curved trunks, at bottom of Upper Bank
- Some slumping/mass-wasting near bottom of Upper Bank
- Down timber

## Site Sketch:



# Connecticut River – Turners Falls Impoundment Riverbank Classification for Land Based Survey

**Observation Point Number:** BC1R      **Date:** *September 24, 2014*

**Station Number:**      *47+50*

## **Bank Vegetation:**

Top: *Heavy (>50%) cover – Needle leaved coniferous tree*

*Tree (90%): eastern white pine\*, hemlock, beech, red oak, black birch*

*Shrub (70%): kalmia angustifolia\*, alder, black birch, white oak, red maple, shadbush, hemlock, blueberry*

*Herbaceous (5%): teaberry, gentian, club mosses, sparse mixed upland grasses*

Face: *Heavy (>50%) cover – Needle leaved coniferous tree*

*Tree (70%): eastern white pine\*, hemlock, beech, red oak, black birch*

*Shrub (50%): beech\*, Kalmia angustifolia, alder, black birch, white oak, red maple, shadbush, hemlock, blueberry*

*Herbaceous (5%): teaberry, gentian, club mosses, sparse mixed upland grasses*

Toe: *None*

*\* Dominant species in each vegetative strata is marked with an \**

*The dominant vegetative strata is the tallest strata with >30% cover*

## **Adjacent Land Use:**

*Forested & Recreational (camping, boating, fishing)*

## **Sensitive Receptor:**

*No*

## **Notes:**

*Peninsula in Barton Cove with shale at toe & a unique natural community, different than other data points*

*Camp Ground Area*

2014 Connecticut River Detailed Site Assessments  
Land-Based Survey Photographs Reference No. 836 - 843  
Location ID BC-1R – September 24, 2014



Photo No. 836



Photo No. 837

**2014 Connecticut River Detailed Site Assessments  
Land-Based Survey Photographs Reference No. 836 - 843  
Location ID BC-1R – September 24, 2014**



Photo No. 838



Photo No. 839

2014 Connecticut River Detailed Site Assessments  
Land-Based Survey Photographs Reference No. 836 - 843  
Location ID BC-1R – September 24, 2014



Photo No. 840



Photo No. 841



**2014 Connecticut River Detailed Site Assessments  
Land-Based Survey Photographs Reference No. 836 - 843  
Location ID BC-1R – September 24, 2014**



Photo No. 842

2014 Connecticut River Detailed Site Assessments  
Land-Based Survey Photographs Reference No. 836 - 843  
Location ID BC-1R – September 24, 2014



Photo No. 843

# Connecticut River – Turners Falls Impoundment Riverbank Detailed Site Assessments

Location ID: 303L

Personnel: YKC, CM, RKS

Date: September 22, 2014

Time: 2:30 PM

Photo Reference Numbers: 795 - 799

Station Number: 940+00

Latitude: 42.76950

Longitude: -72.48410

Left or Right Bank (Looking Downstream): Left

Previously Stabilized? No

## Geologic / Geotechnical Observations:

### Stratigraphy:

(Refer to Site Sketch below for locations of soil/rock layers)

Notations in parentheses are based on Unified Soil Classification System)

Upper Bank: SANDY SILT (ML) – Low plasticity, approx. 20% - 30% fine sand, gray.

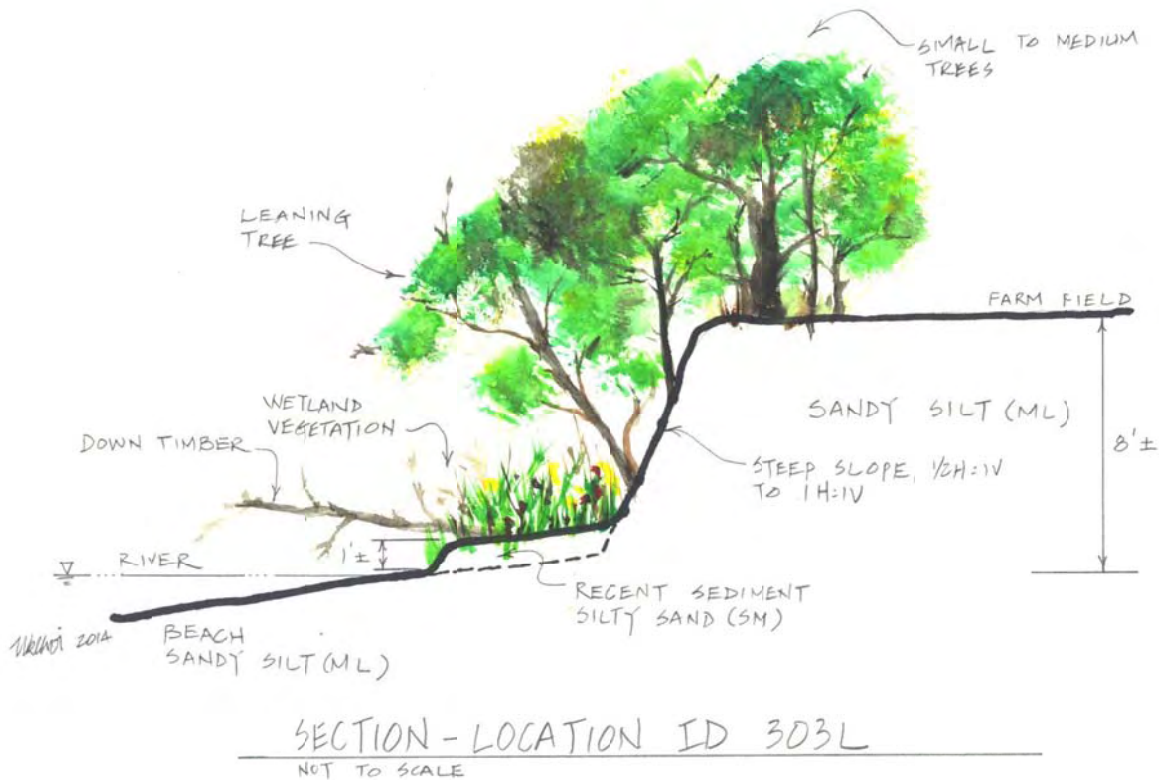
Lower Bank: SANDY SILT (ML) – Low plasticity, approx. 20% - 30% fine sand, dark gray.

Recent Sediment: SILTY SAND (SM) – Mostly fine sand, approx. 10% - 20% low-plasticity fines, mottled.

## Observed Erosion Features:

- No erosion observed on Lower Bank, the top of which was filled with recent sediments.
- Steep slopes, entire Upper Bank.
- Some undercuts with exposed roots.
- Leaning trees.
- Few down timber

## Site Sketch:



# Connecticut River – Turners Falls Impoundment Riverbank Classification for Land Based Survey

Observation Point Number: 303L      Date: September 22, 2014

Station Number:            940+00

## Bank Vegetation:

Top: Heavy (>50%) cover – Broad leaved deciduous tree

Tree (60%): silver maple\*, green ash, elm

Shrub (60%): staghorn sumac\*, ash, honeysuckle, elm

Vine (35%): bittersweet\*, grape

Herbaceous (5%): sparse mixed grasses, joe-pye weed

Face: Moderate (25-50%) cover – Broad leaved deciduous tree

Tree (35%): silver maple\*, hickory, ash, elm

Shrub (30%): multiflora rose\*, ash saplings, sumac, maple saplings, willow

Herbaceous (25%): Solidago spp., mixed asters, raspberry, Equisetum spp.

Toe: None to Very Sparse – mixed persistent & non-persistent emergent

Herbaceous (65%): woolgrass\*, reed (Phragmites australis), sedges and rushes (inc. Caladium mariscoides, Juncus canadensis, umbrella sedge, Eleocharis spp., Juncus effusus, Carex crinita), Polygonum spp., beggartick (Bidens spp.), panic grass, Sagittaria spp., purple loosestrife

\* Dominant species in each vegetative strata is marked with an \*

The dominant vegetative strata is the tallest strata with >30% cover

## Adjacent Land Use:

Agricultural

## Sensitive Receptor:

Yes – kingfisher nest cavity

## Notes:

Recent sediment deposit on bench supports diverse community of persistent & non-persistent emergent vegetation

Sensitive receptor site in eroding vertical sandy bank face (kingfisher nest cavity)

Bonnett Farm site

Little riparian forested buffer separating the bank from the field edge

Invasive species present including bittersweet, purple loosestrife & multiflora rose

**2014 Connecticut River Detailed Site Assessments  
Land-Based Survey Photographs Reference No. 795 - 799  
Location ID 303L – September 22, 2014**



Photo No. 795



Photo No. 796

2014 Connecticut River Detailed Site Assessments  
Land-Based Survey Photographs Reference No. 795 - 799  
Location ID 303L – September 22, 2014



Photo No. 797

2014 Connecticut River Detailed Site Assessments  
Land-Based Survey Photographs Reference No. 795 - 799  
Location ID 303L – September 22, 2014



Photo No. 798



Photo No. 799

# Connecticut River – Turners Falls Impoundment Riverbank Detailed Site Assessments

Location ID: 119BL

Personnel: YKC, CM, RKS

Date: September 24, 2014

Time: 2:15 PM

Photo Reference Numbers: 866, 867, 869, 870

Station Number: 407+00

Latitude: 42.64167

Longitude: -72.47889

Left or Right Bank (Looking Downstream): Left

Previously Stabilized? No

## Geologic / Geotechnical Observations:

### Stratigraphy:

(Refer to Site Sketch below for locations of soil/rock layers)

Notations in parentheses are based on Unified Soil Classification System)

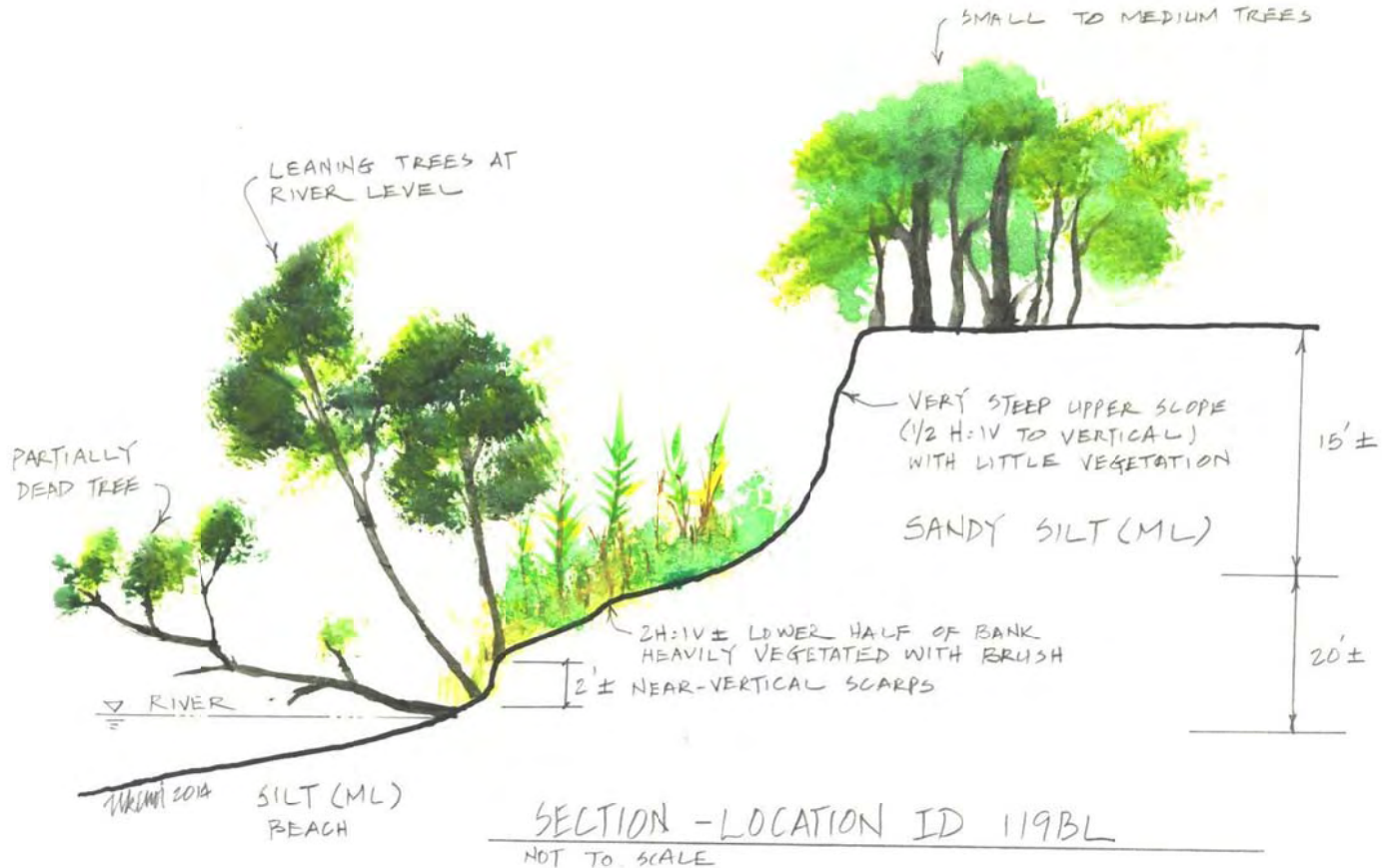
Upper Bank: SANDY SILT (ML) – Low plasticity, approx. 20% - 30% fine sand, brown. Pockets of clean sand with fine gravel.

Lower Bank: SILT (ML) – Low plasticity, <5% fine sand, tan.

## Observed Erosion Features:

- Leaning trees at river level.
- Numerous small slumps on lower half of Upper Bank slope
- Very steep slopes at upper half of Upper Bank
- Near-vertical scarps at river level

## Site Sketch:





# Connecticut River – Turners Falls Impoundment Riverbank Classification for Land Based Survey

Observation Point Number: 119(B)L Date: September 24, 2014

Station Number: 407+00

## Bank Vegetation:

Top: Moderate (25-50%) cover – Broad leaved deciduous tall shrub/sapling

Tree (10%): ash\*, red oak, basswood, elm, ashleaf maple

Shrub (50%): staghorn sumac\*, basswood, elm

Vine (5%): bittersweet\*

Face: Moderate (25-50%) cover – Broad leaved deciduous tall shrub/sapling

Tree (5%): basswood\*, elm

Shrub (30%): staghorn sumac\*, multiflora rose, elm, quaking aspen, sycamore sapling, purple loosestrife

Herbaceous (75%): mixed grasses (inc. Phalaris arundinacea\*, Calamagrostis canadensis), cattails, pokeweed, mixed goldenrods (Solidago spp.), mixed asters, common reed (Phragmites australis), raspberry, horsetail (Equisetum spp.)

Toe: None to Very Sparse – Robust persistent emergent

Herbaceous (<5%): reed (Phragmites australis)

\* Dominant species in each vegetative strata is marked with an \*

The dominant vegetative strata is the tallest strata with >30% cover

## Adjacent Land Use:

Agricultural

## Sensitive Receptor:

Yes

## Notes:

Very steep and actively eroding with areas of vertical sandy bank suitable for Sensitive Receptor sites

Phragmites patch present at toe

Invasive species present including multiflora rose, bittersweet, purple loosestrife, and Phragmites

**2014 Connecticut River Detailed Site Assessments**  
**Land-Based Survey Photographs Reference No. 866, 867, 869, 870**  
**Location ID 119BL – September 24, 2014**



Photo No. 866



Photo No. 867

2014 Connecticut River Detailed Site Assessments  
Land-Based Survey Photographs Reference No. 866, 867, 869, 870  
Location ID 119BL – September 24, 2014



Photo No. 869



Photo No. 870

# Connecticut River – Turners Falls Impoundment Riverbank Detailed Site Assessments

Location ID: 87BL

Personnel: YKC, CM, RKS

Date: September 25, 2014

Time: 10:40 AM

Photo Reference Numbers: 892 - 897

Station Number: 307+50

Latitude: 42.61982

Longitude: -72.47829

Left or Right Bank (Looking Downstream): Left

Previously Stabilized? No

## Geologic / Geotechnical Observations:

### Stratigraphy:

(Refer to Site Sketch below for locations of soil/rock layers)

Notations in parentheses are based on Unified Soil Classification System)

Upper Bank: SANDY SILT (ML) – Low plasticity, approx. 10% - 20% fine sand, brown.

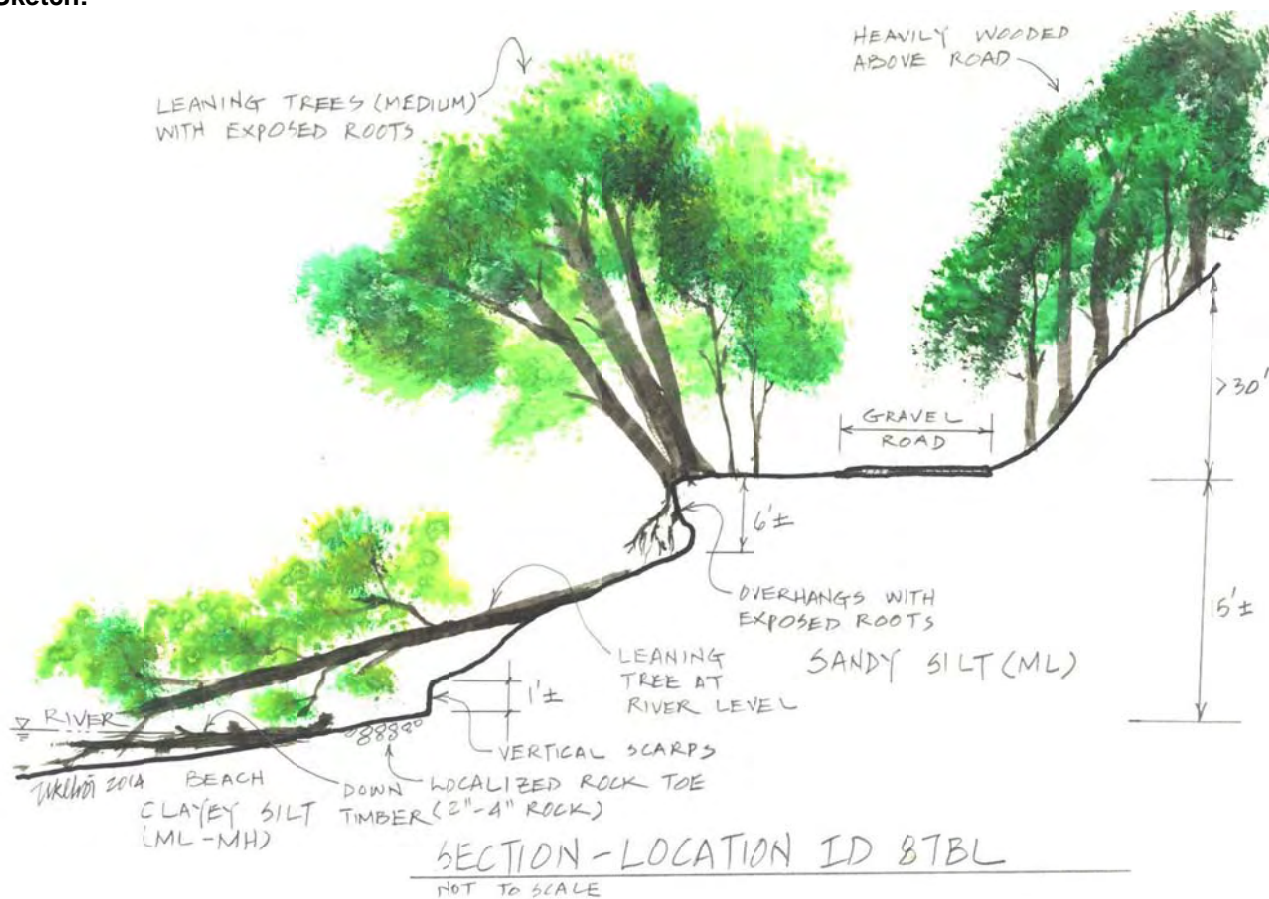
Lower Bank: CLAYEY SILT (ML, MH) – Medium plasticity, <10% fine sand, very soft, gray.

Lower Bank: Rock Toe – 2" – 4" riprap rock, localized.

## Observed Erosion Features:

- Overhangs with leaning trees and exposed roots on slopes just below gravel road
- Fallen live trees at river level
- Vertical scarps just above rock toe.

## Site Sketch:



# Connecticut River – Turners Falls Impoundment Riverbank Classification for Land Based Survey

Observation Point Number: 87(B)L Date: September 25, 2014

Station Number: 307+50

## Bank Vegetation:

Top: Heavy (>50%) cover – Broad leaved deciduous tree

Tree (85%): ash\*, gray birch, elm, black birch, hickory

Shrub (5%): Japanese barberry\*, multiflora rose

Herbaceous (40%): ostrich fern, sensitive fern, garlic mustard, mixed Solidago spp., mixed asters, Jerusalem artichoke

Face: Moderate (25-50%) cover – Broad leaved deciduous tree

Tree (40%): ash\*, elm, gray birch

Shrub (30%): multiflora rose\*, elm, Japanese barberry, staghorn sumac, black birch sapling, alder, purple loosestrife, highbush blueberry, Spiraea angustifolia

Herbaceous (70%): mixed grasses (inc. Phalaris arundinacea\*, river rye), ostrich fern, milkweed, mixed goldenrods (Solidago spp.), mixed asters, swamp hempweed, mixed sedges (inc. Carex stricta), garlic mustard, Juncus effusus

Toe: Sparse – Broad leaved deciduous tree

Tree (<5%): basswood (overhanging/fallen tree)

\* Dominant species in each vegetative strata is marked with an \*

The dominant vegetative strata is the tallest strata with >30% cover

## Adjacent Land Use:

Forested & light transportation (Pine Meadow Road)

## Sensitive Receptor:

No

## Notes:

Just downstream from Shearer restoration site

Bank is very high and steep here with active erosion

Very little bittersweet here (~1%), but other invasives present, such as Japanese barberry, purple loosestrife, and multiflora rose

**2014 Connecticut River Detailed Site Assessments  
Land-Based Survey Photographs Reference No. 892 - 897  
Location ID 87BL – September 25, 2014**



Photo No. 892



Photo No. 893

2014 Connecticut River Detailed Site Assessments  
Land-Based Survey Photographs Reference No. 892 - 897  
Location ID 87BL – September 25, 2014



Photo No. 894



Photo No. 895

**2014 Connecticut River Detailed Site Assessments  
Land-Based Survey Photographs Reference No. 892 - 897  
Location ID 87BL – September 25, 2014**



Photo No. 896



**2014 Connecticut River Detailed Site Assessments  
Land-Based Survey Photographs Reference No. 892 - 897  
Location ID 87BL – September 25, 2014**



Photo No. 897

# Connecticut River – Turners Falls Impoundment Riverbank Detailed Site Assessments

Location ID: 75L

Personnel: YKC, CM, RKS

Date: September 25, 2014

Time: 11:05 AM

Photo Reference Numbers: 898 - 904

Station Number: 270+00

Latitude: 42.60946

Longitude: -72.48226

Left or Right Bank (Looking Downstream): Left

Previously Stabilized? No

## Geologic / Geotechnical Observations:

### Stratigraphy:

(Refer to Site Sketch below for locations of soil/rock layers)

Notations in parentheses are based on Unified Soil Classification System)

Upper Bank, Lower slope: SAND (SP, SP-SM) – Fine sand, approx. 5% - 10% nonplastic fines, brown.

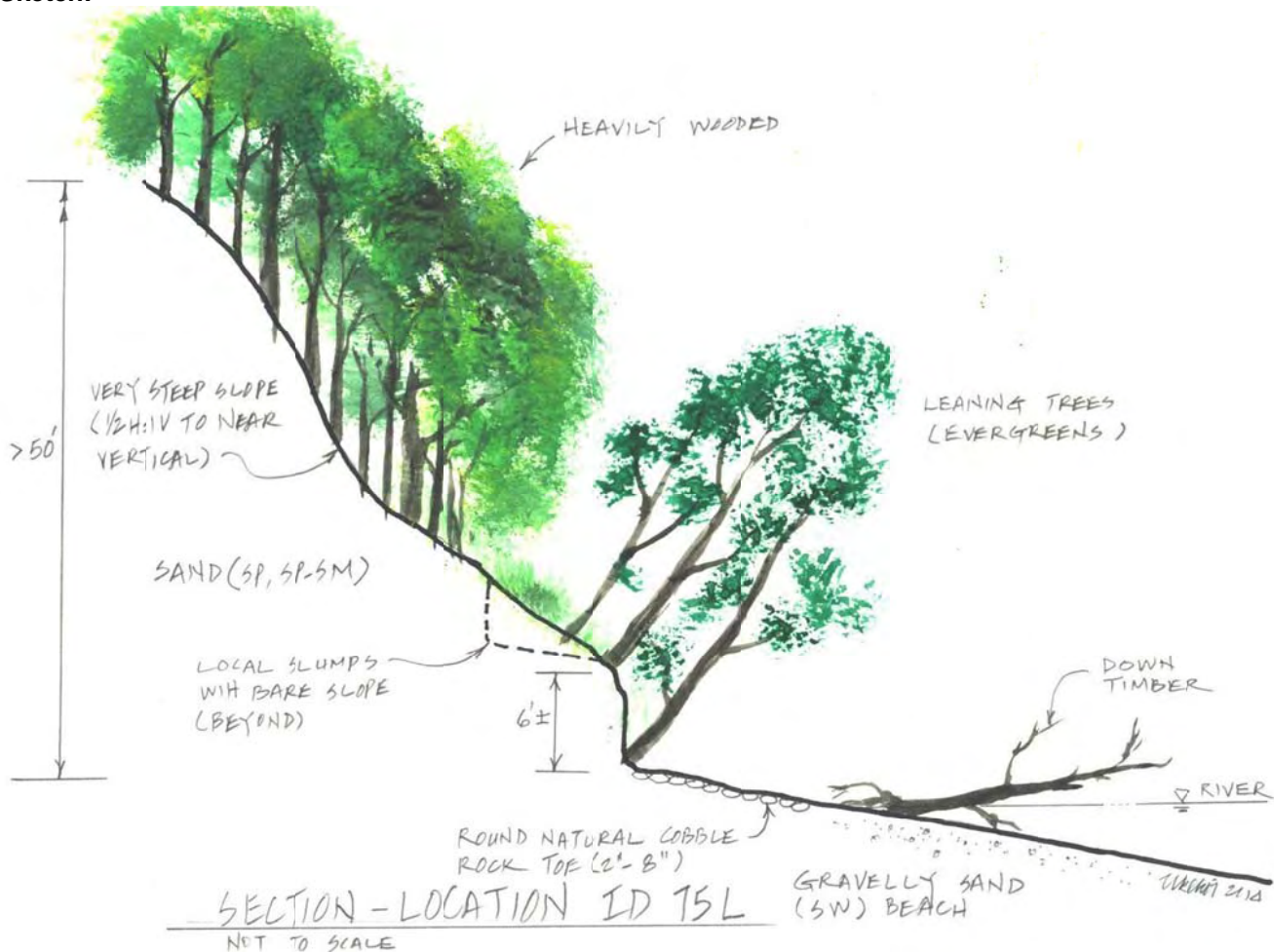
Lower Bank: GRAVELLY SAND (SW) – Fine to coarse sand, approx. 40% - 50% rounded gravel, <5% nonplastic fines

Lower Bank: Rock Toe – 2" – 8" rounded natural cobbles, hard, durable.

## Observed Erosion Features:

- Very steep slope, entire Upper Bank.
- Near-vertical slope at river level, with some undercuts, leaning trees and exposed roots
- Local slumps and mass-wasting with bare slope, lower half of Upper Bank

## Site Sketch:



# Connecticut River – Turners Falls Impoundment Riverbank Classification for Land Based Survey

Observation Point Number: 75L      Date: September 25, 2014

Station Number: 270+00

## Bank Vegetation:

Top: Heavy (90%) cover – Needle leaved coniferous tree

Tree (90%): hemlock\*, eastern white pine, red oak, white birch, black birch, black cherry

Shrub (5%): hemlock saplings, black birch saplings, alder, ash

Herbaceous (2%): Christmas fern, mosses

Face: Moderate (25-50%) cover – Needle leaved coniferous tall shrub/sapling

Tree (<5%): hemlock\*, eastern white pine, birch

Shrub (35%): hemlock\*, sumac, eastern white pine, birches, barberry, box elder, multiflora rose, honeysuckle

Herbaceous (1%): Christmas fern, mixed grasses

Toe: none

Natural round cobble/gravel at toe

\* Dominant species in each vegetative strata is marked with an \*

The dominant vegetative strata is the tallest strata with >30% cover

## Adjacent Land Use:

Forested further back from restoration site, & Agricultural (row crop – cow corn)

## Sensitive Receptor:

No

## Notes:

Data point ID 35 (12/12/2013) in same location (see that data in 2013 FRR Land Based Evaluation, data point #35)

Very little bittersweet here (1%)

Japanese barberry, multiflora rose & honeysuckle are present

**2014 Connecticut River Detailed Site Assessments  
Land-Based Survey Photographs Reference No. 898 - 904  
Location ID 75L – September 25, 2014**



Photo No. 898



Photo No. 899

**2014 Connecticut River Detailed Site Assessments  
Land-Based Survey Photographs Reference No. 898 - 904  
Location ID 75L – September 25, 2014**



Photo No. 900

2014 Connecticut River Detailed Site Assessments  
Land-Based Survey Photographs Reference No. 898 - 904  
Location ID 75L – September 25, 2014



Photo No. 901

**2014 Connecticut River Detailed Site Assessments  
Land-Based Survey Photographs Reference No. 898 - 904  
Location ID 75L – September 25, 2014**



Photo No. 902

**2014 Connecticut River Detailed Site Assessments  
Land-Based Survey Photographs Reference No. 898 - 904  
Location ID 75L – September 25, 2014**



Photo No. 903



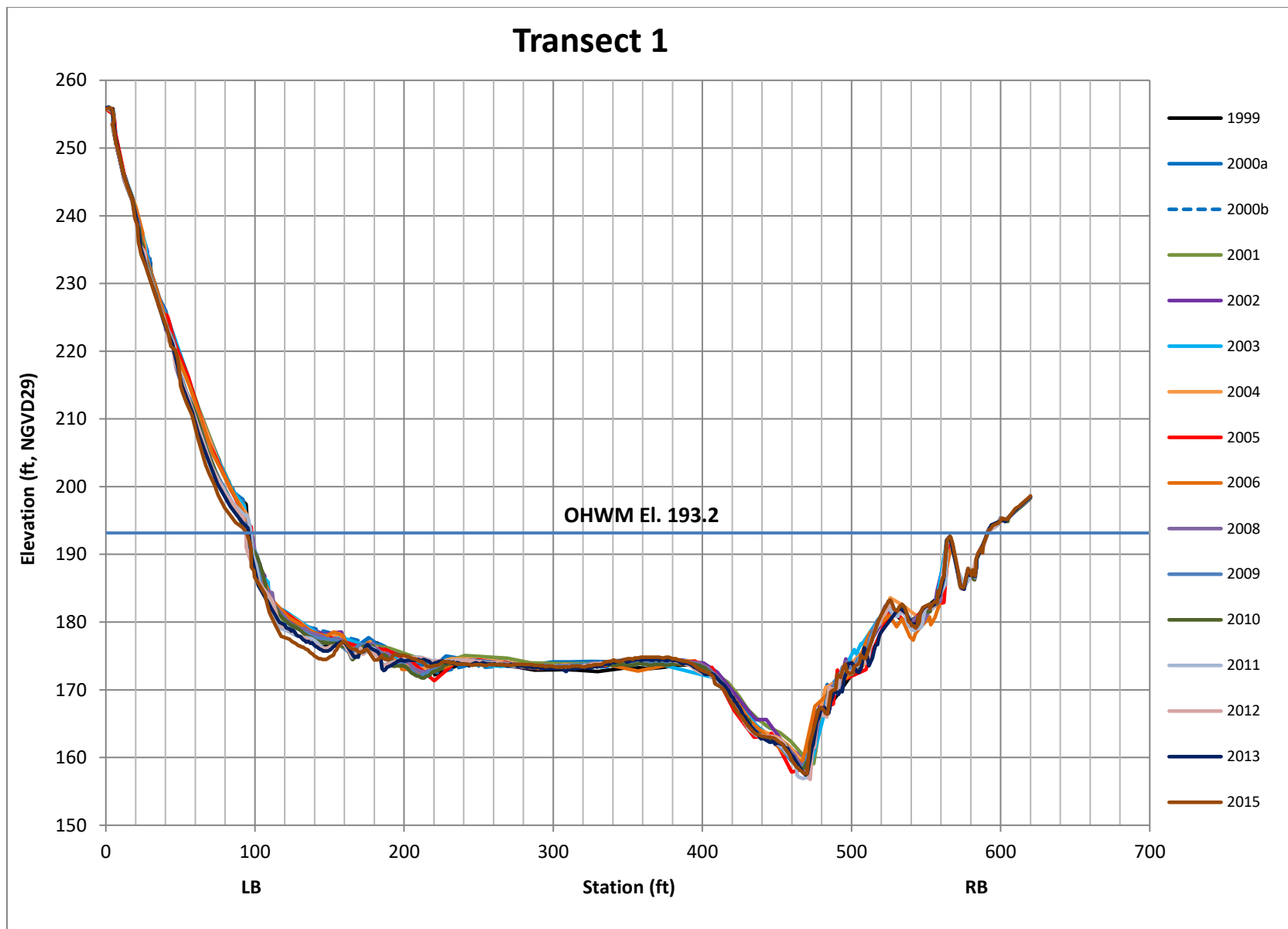
2014 Connecticut River Detailed Site Assessments  
Land-Based Survey Photographs Reference No. 898 - 904  
Location ID 75L – September 25, 2014

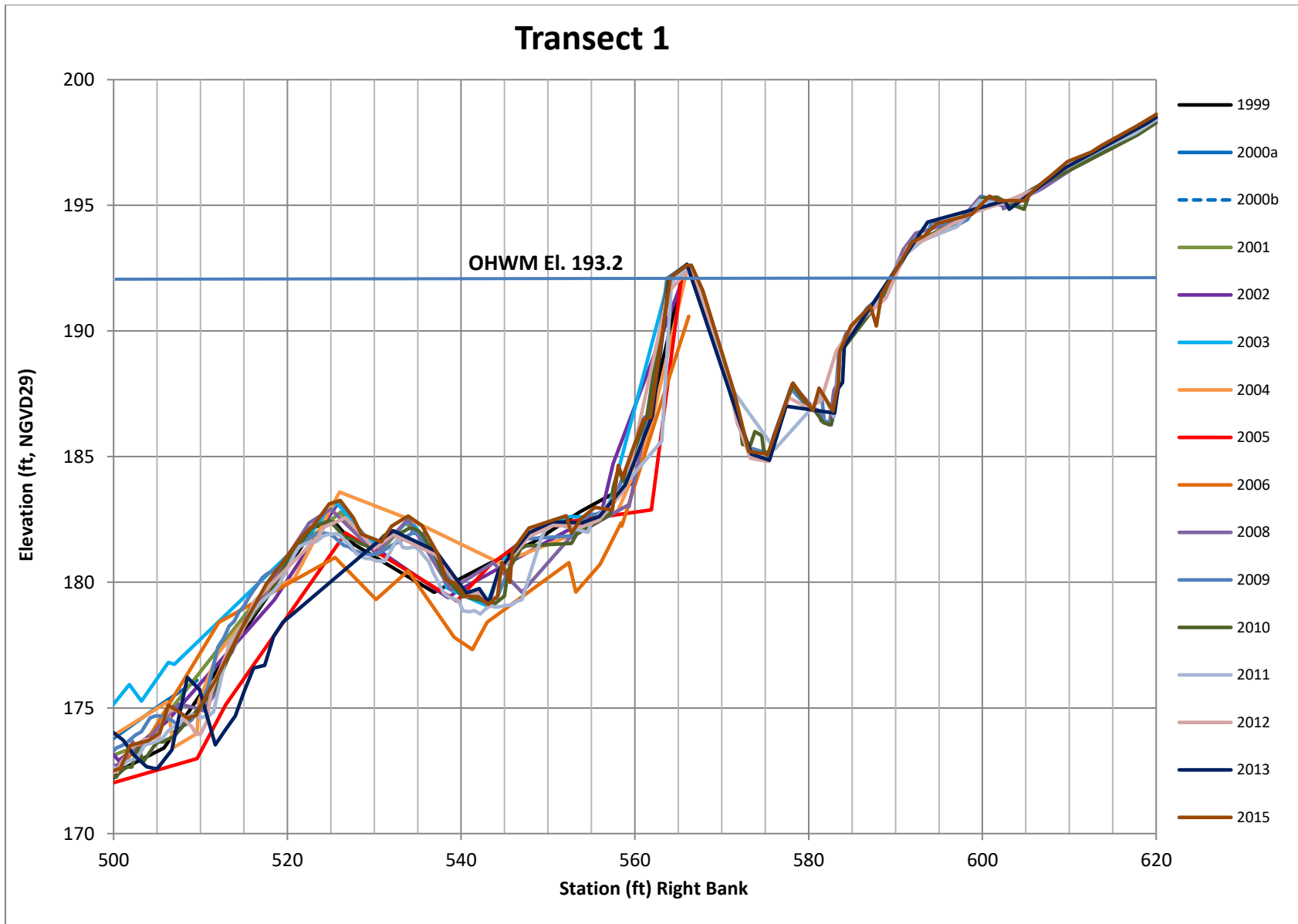


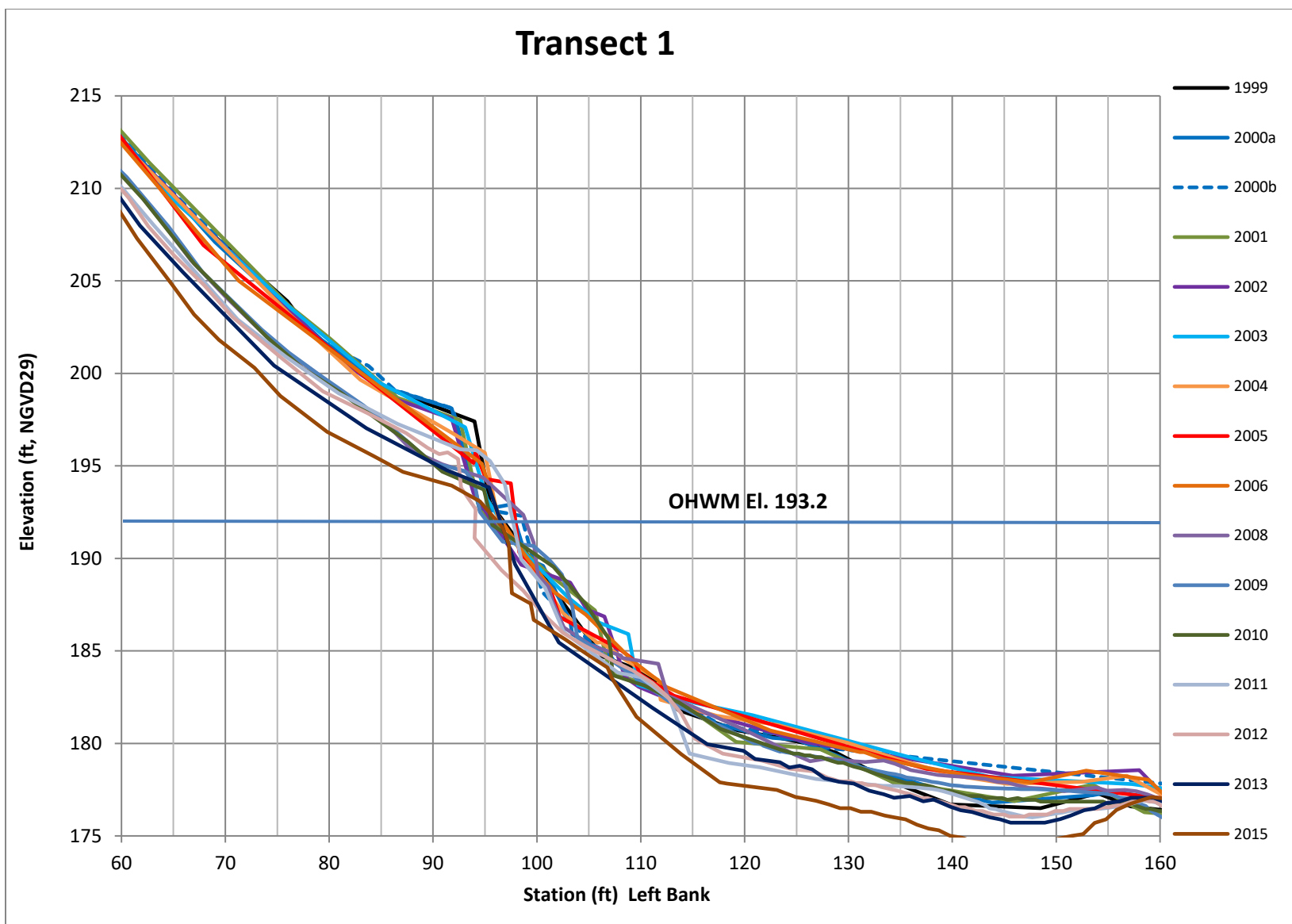
Photo No. 904

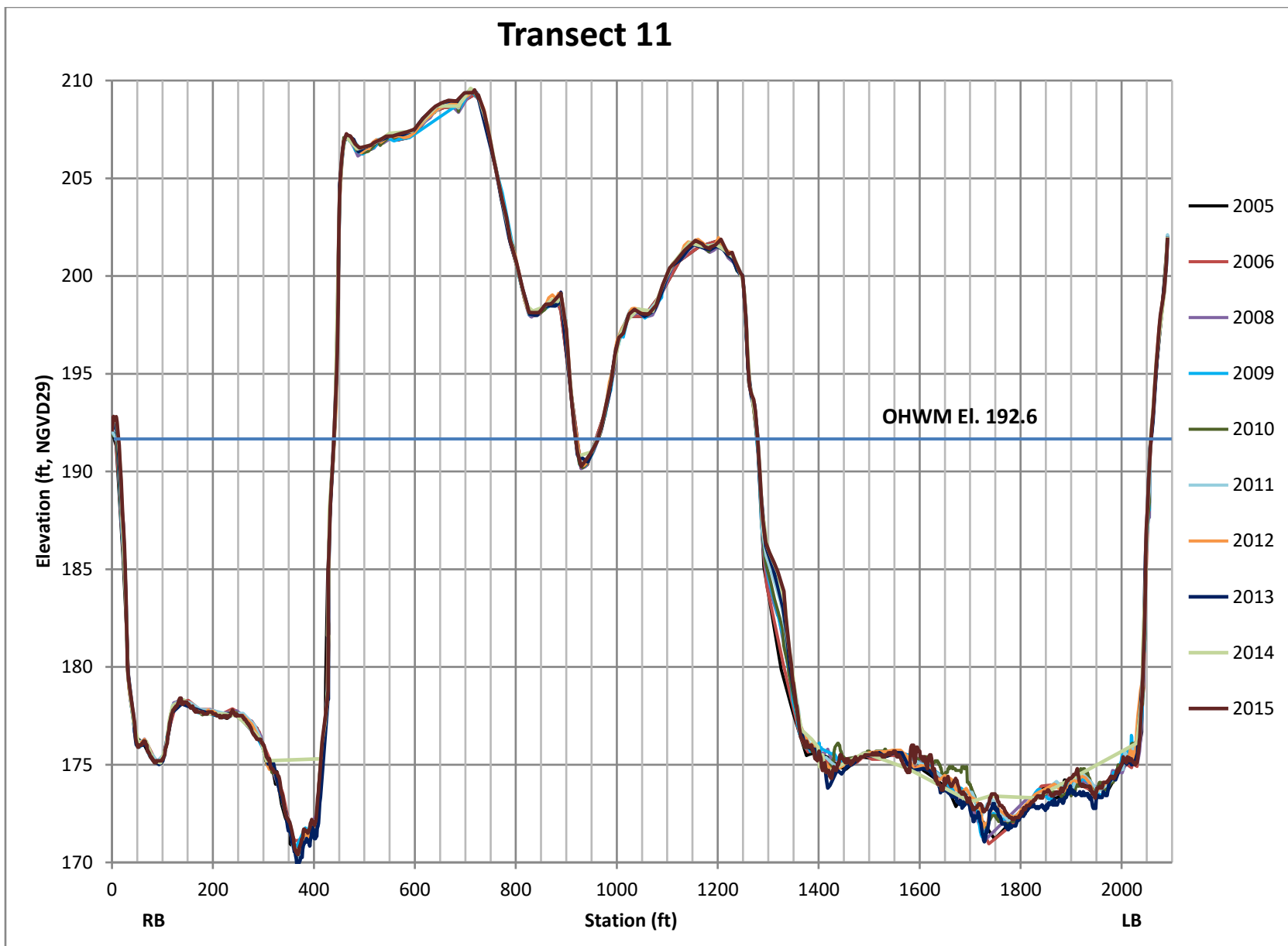
## **APPENDIX E – TURNERS FALLS IMPOUNDMENT SURVEYED CROSS- SECTIONS 1999-2015**

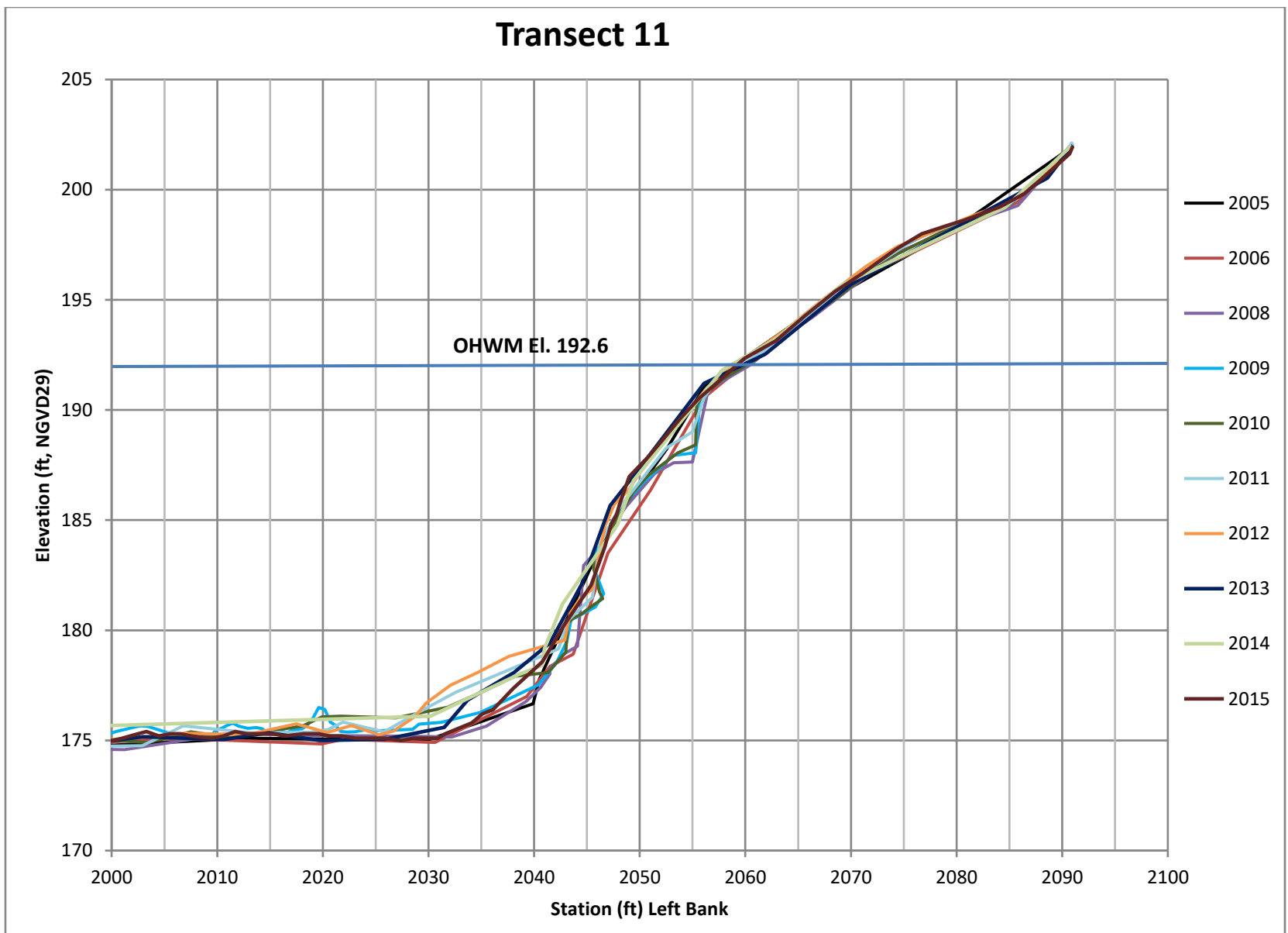
Note: cross-sections are labeled with left and right banks as if looking in the downstream direction. Cross-section graphs themselves may either be plotted looking upstream or downstream depending on stationing provided in the cross-section data files. Those graphs plotted such that the left bank is on the right side of the graph means that the cross-section was plotted looking upstream rather than downstream meaning that the stationing started on the right bank.

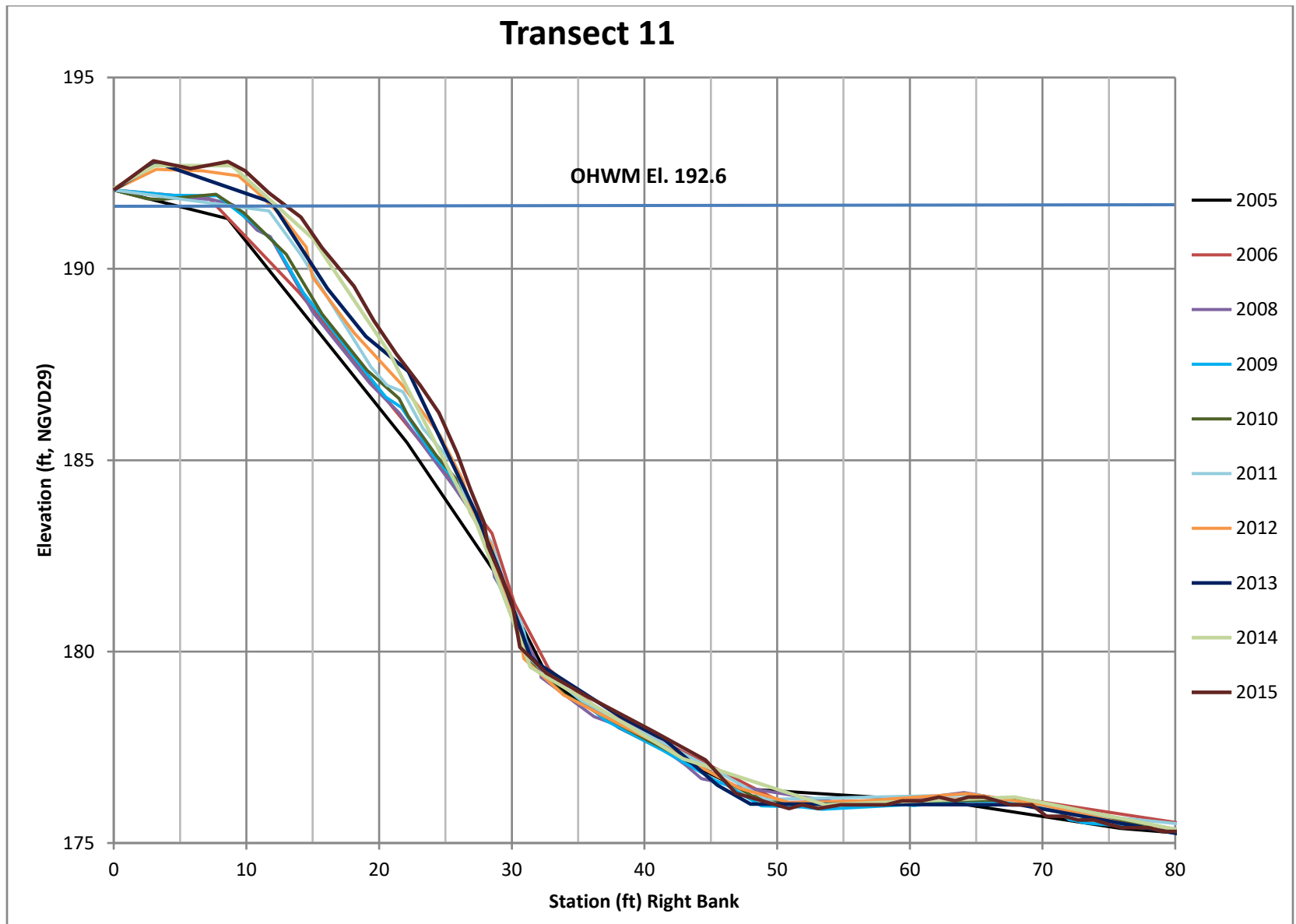




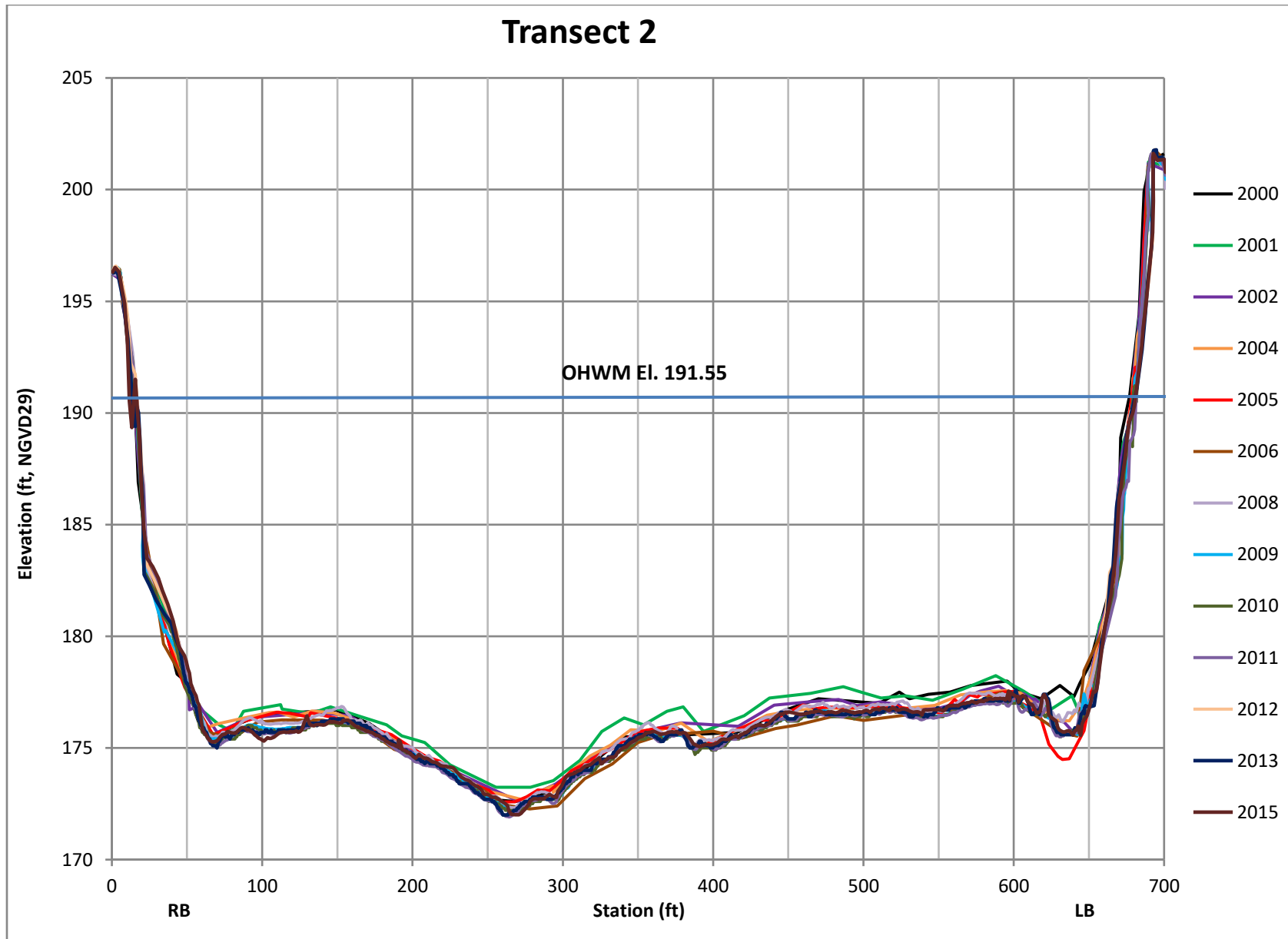


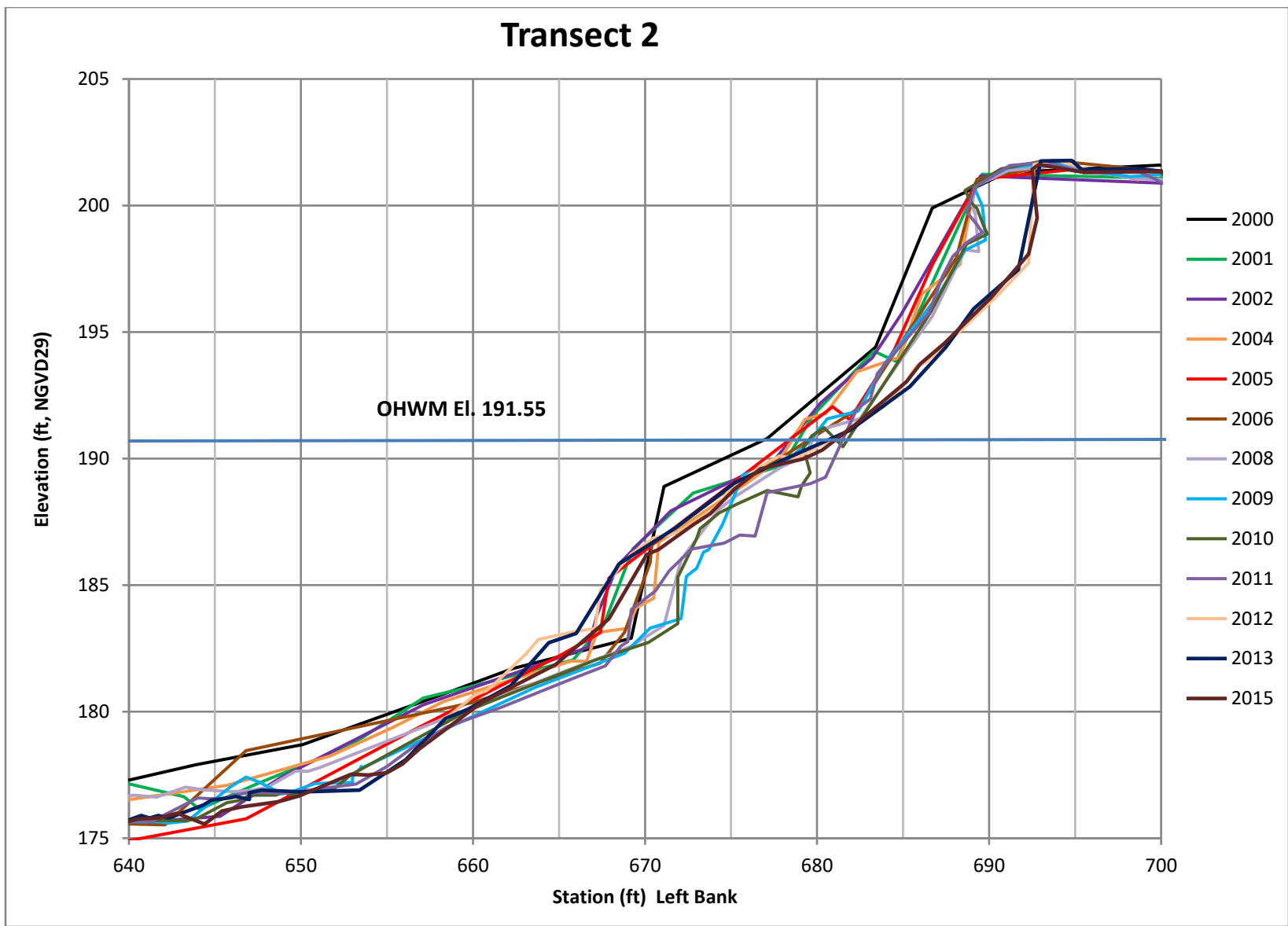


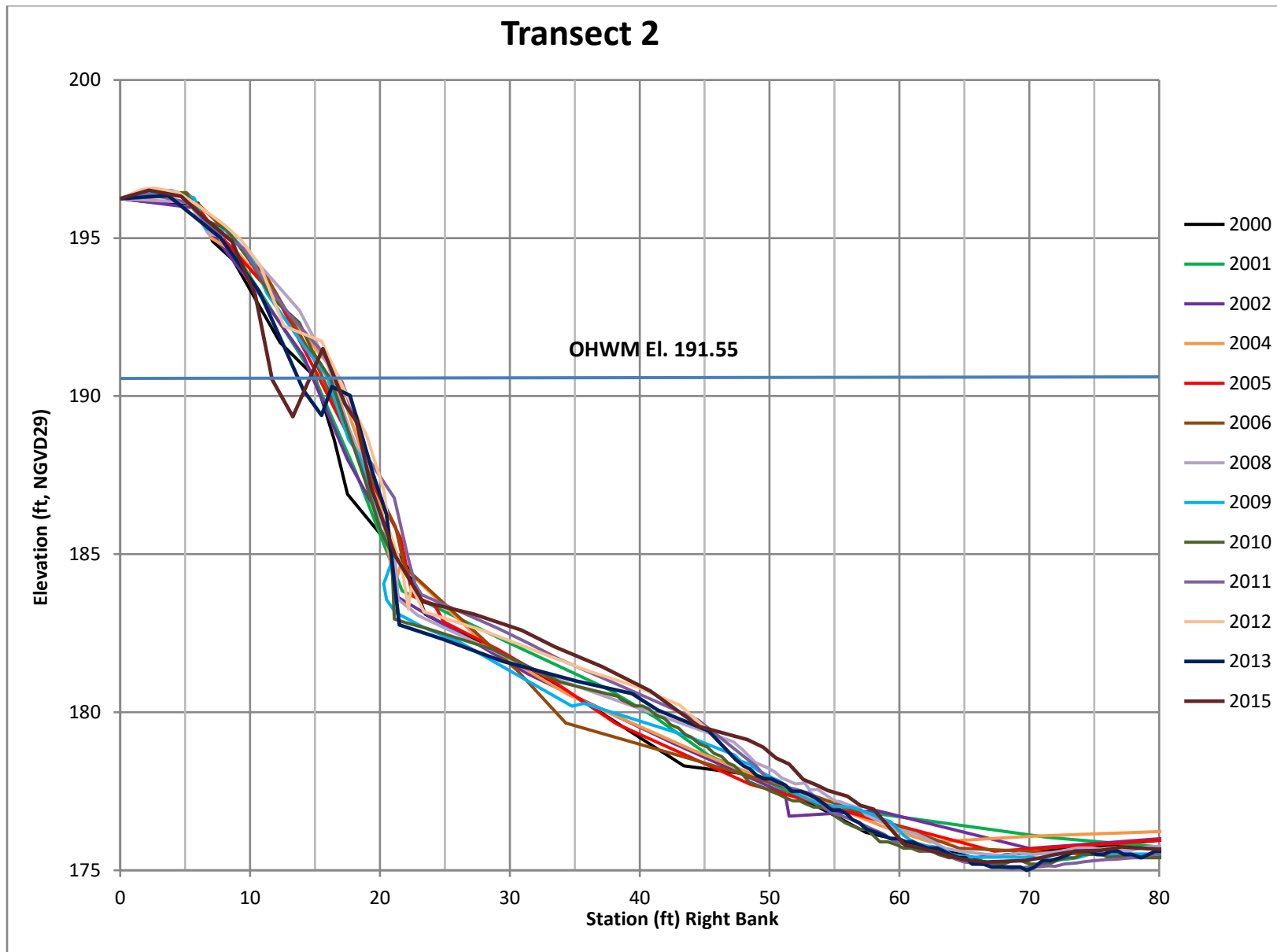




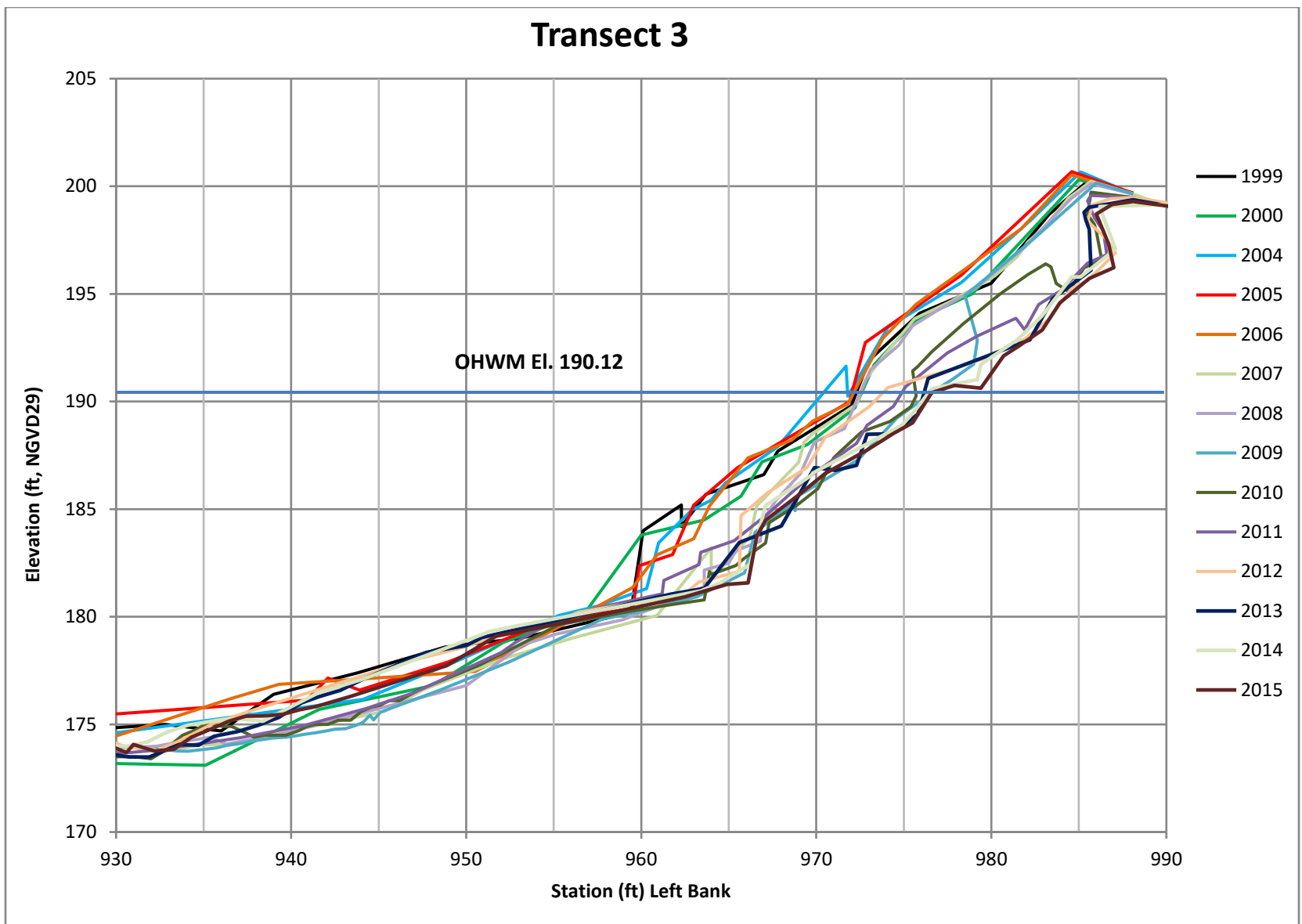


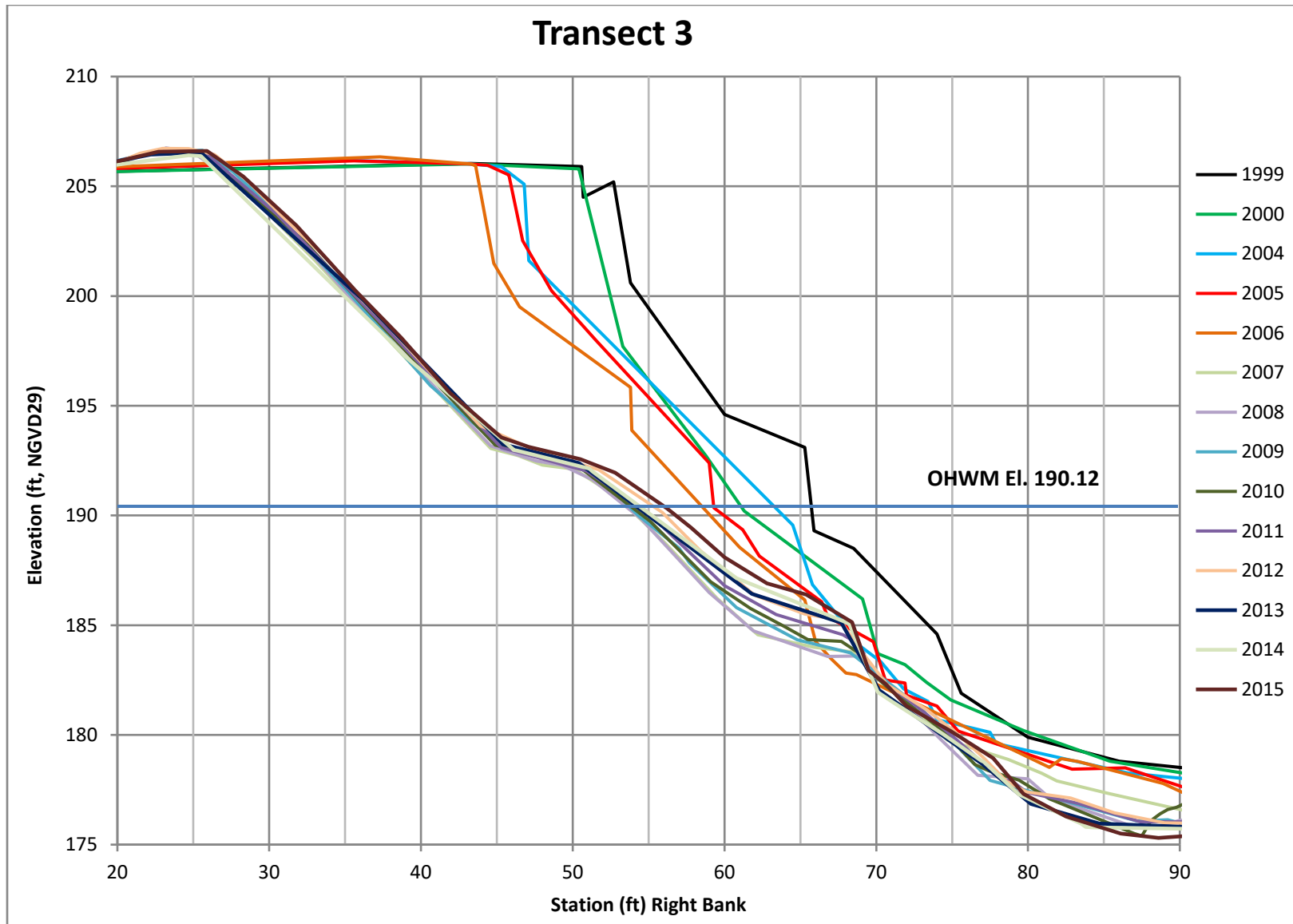


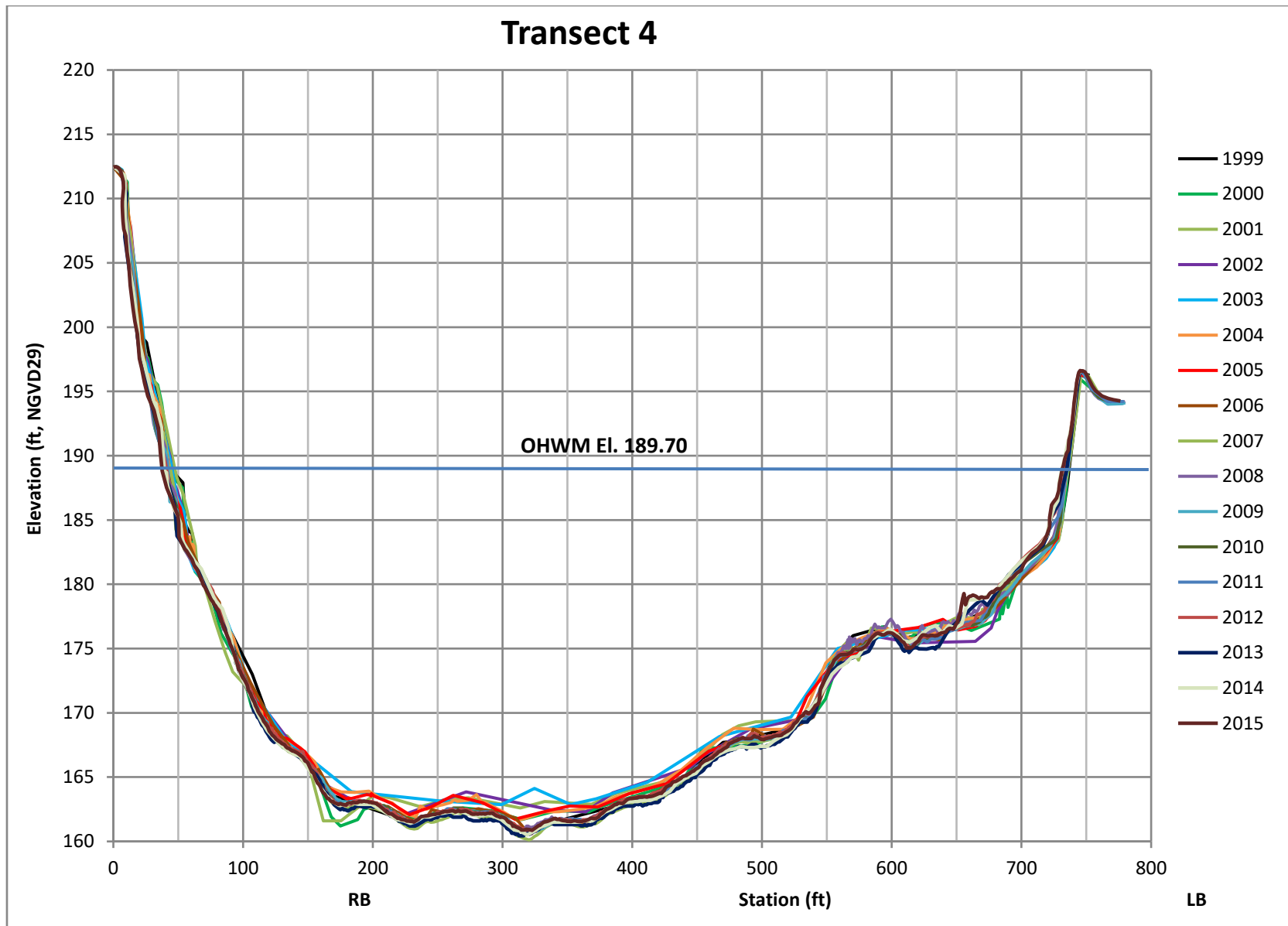


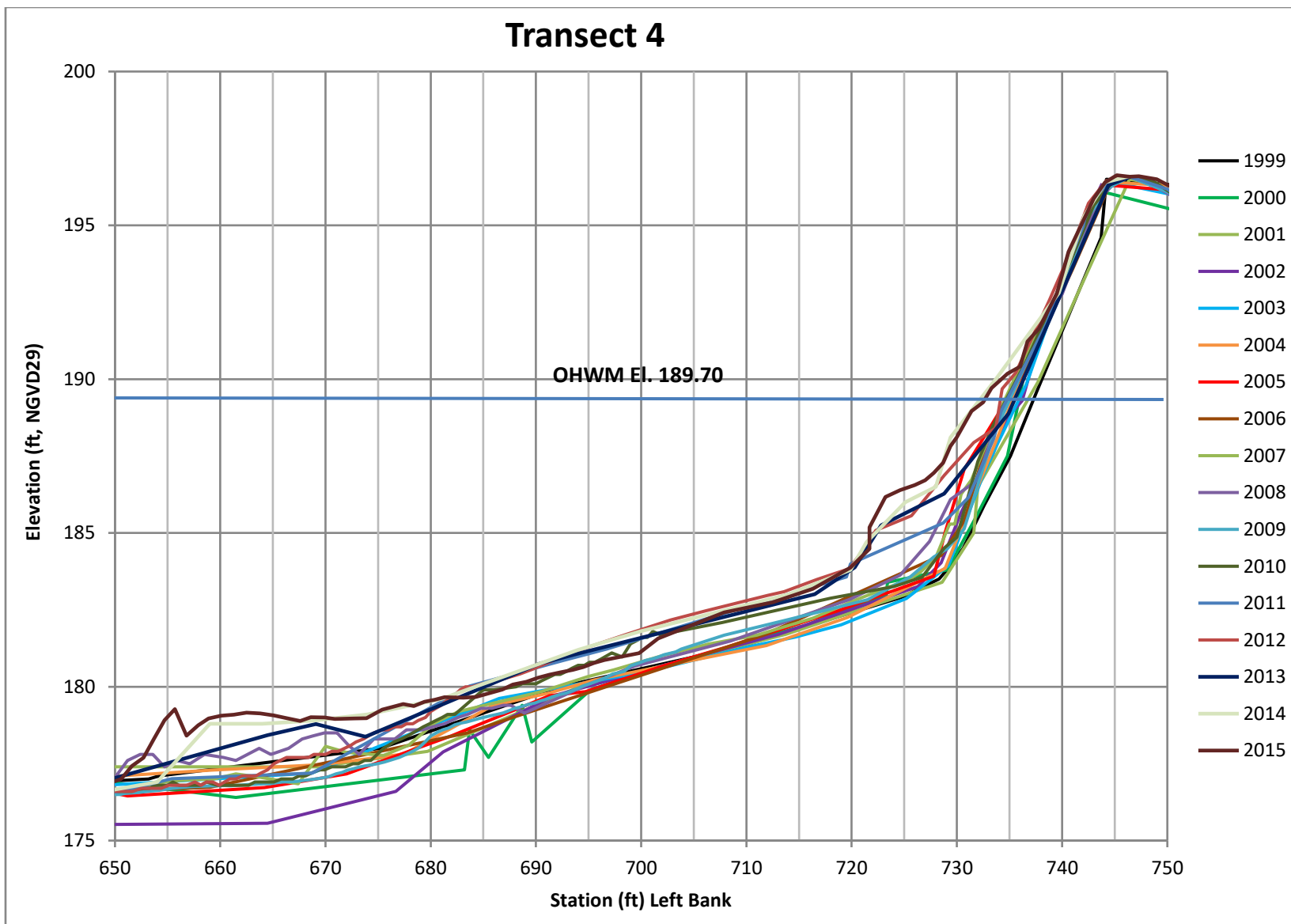




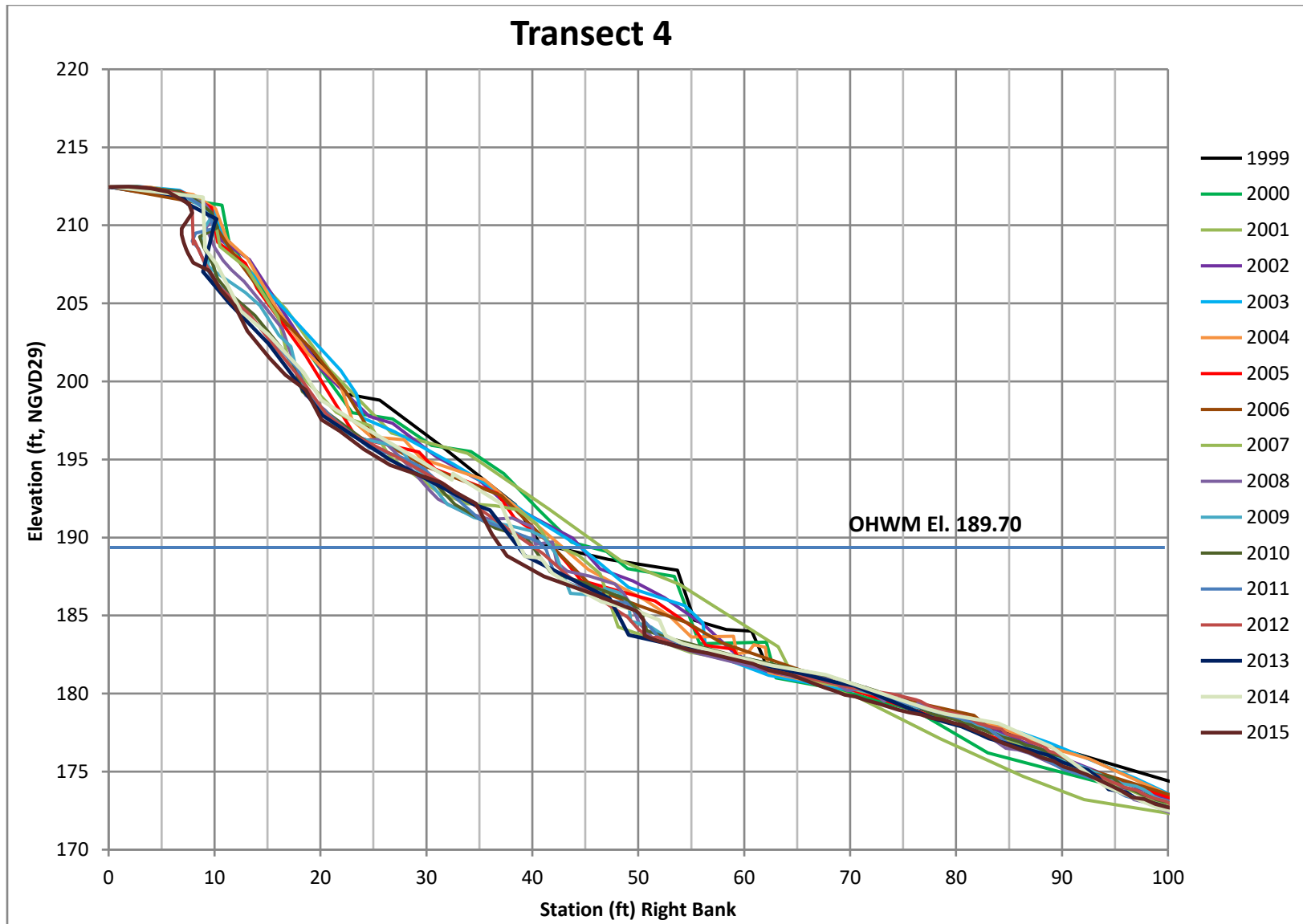


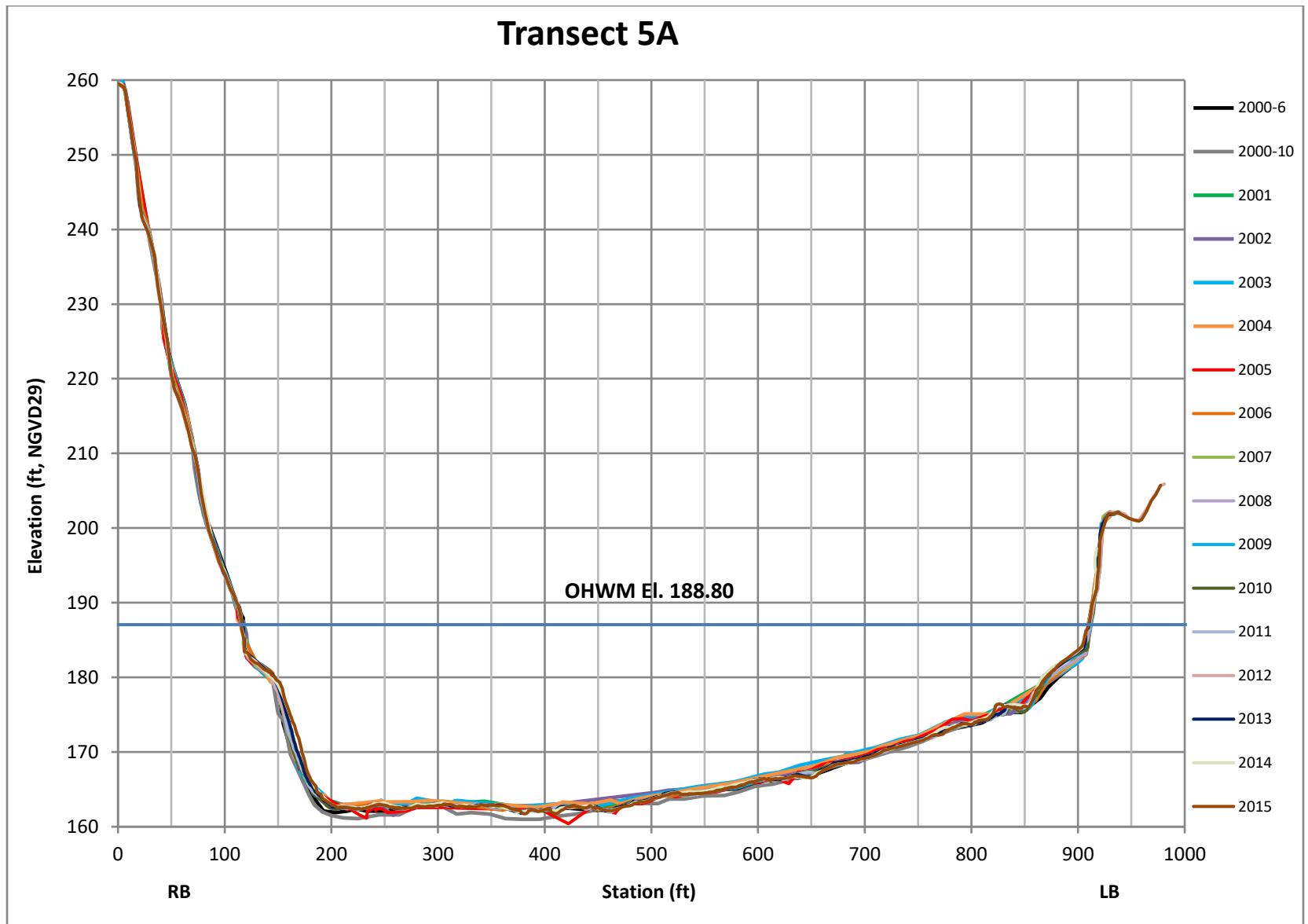


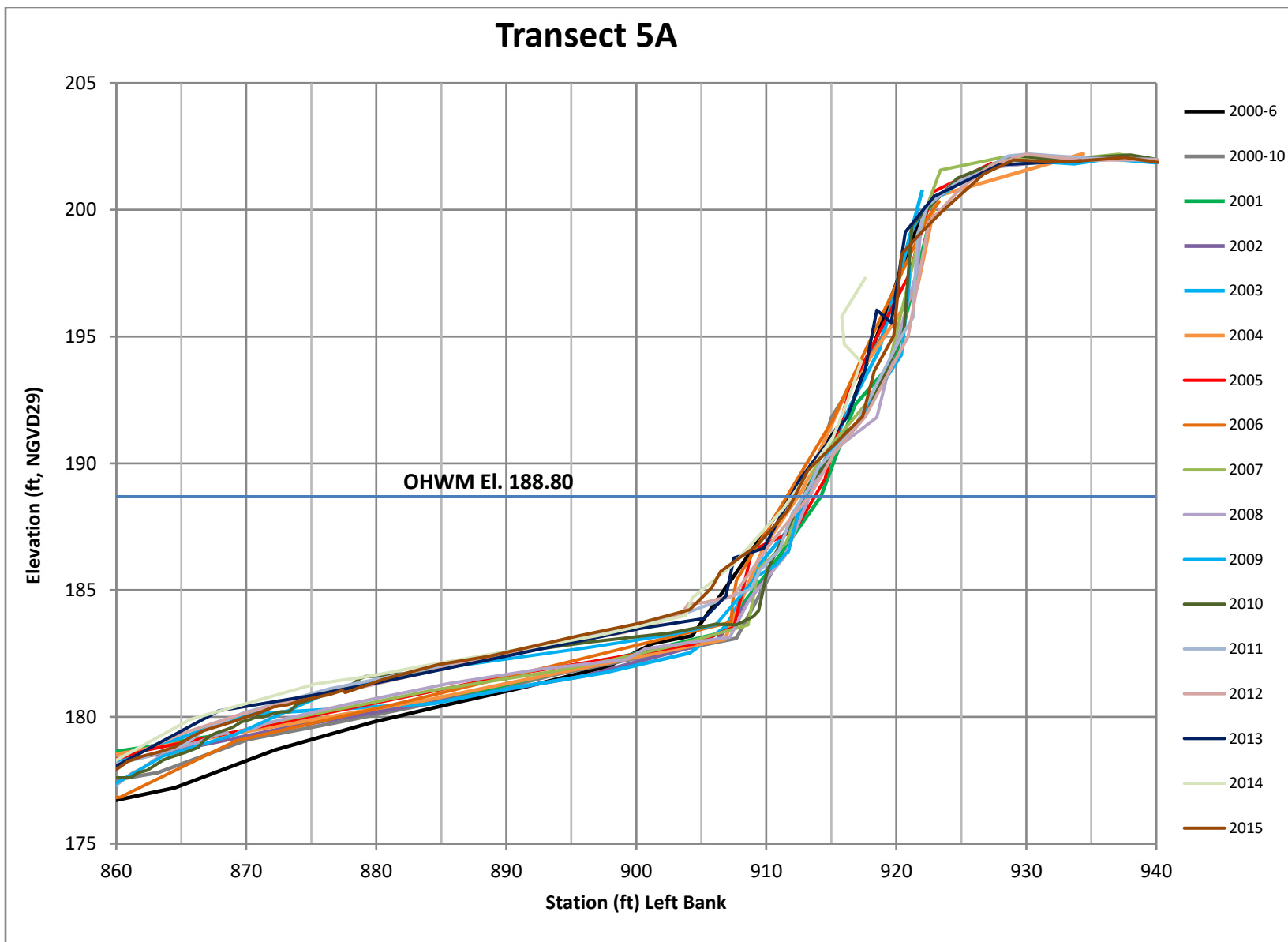


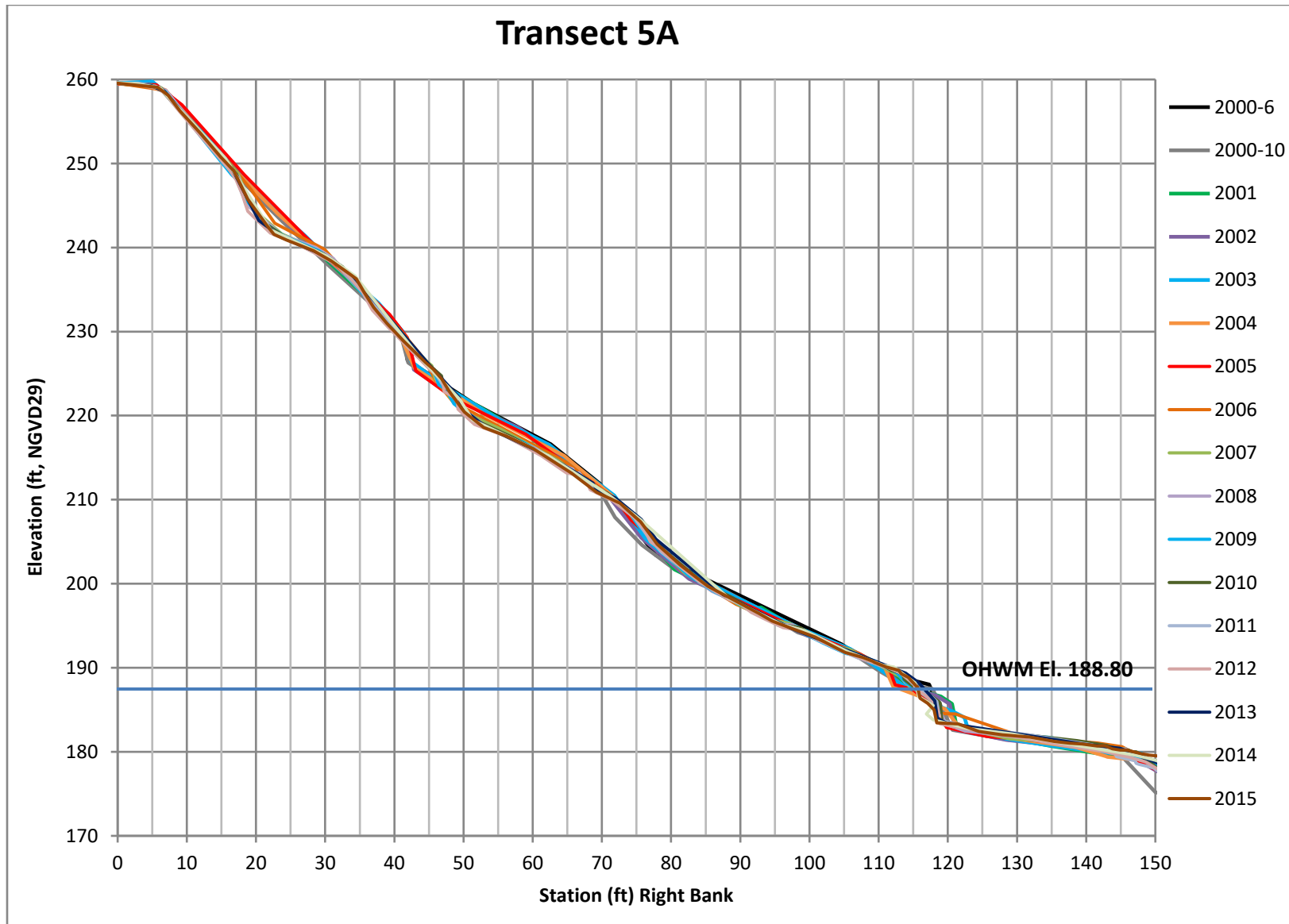


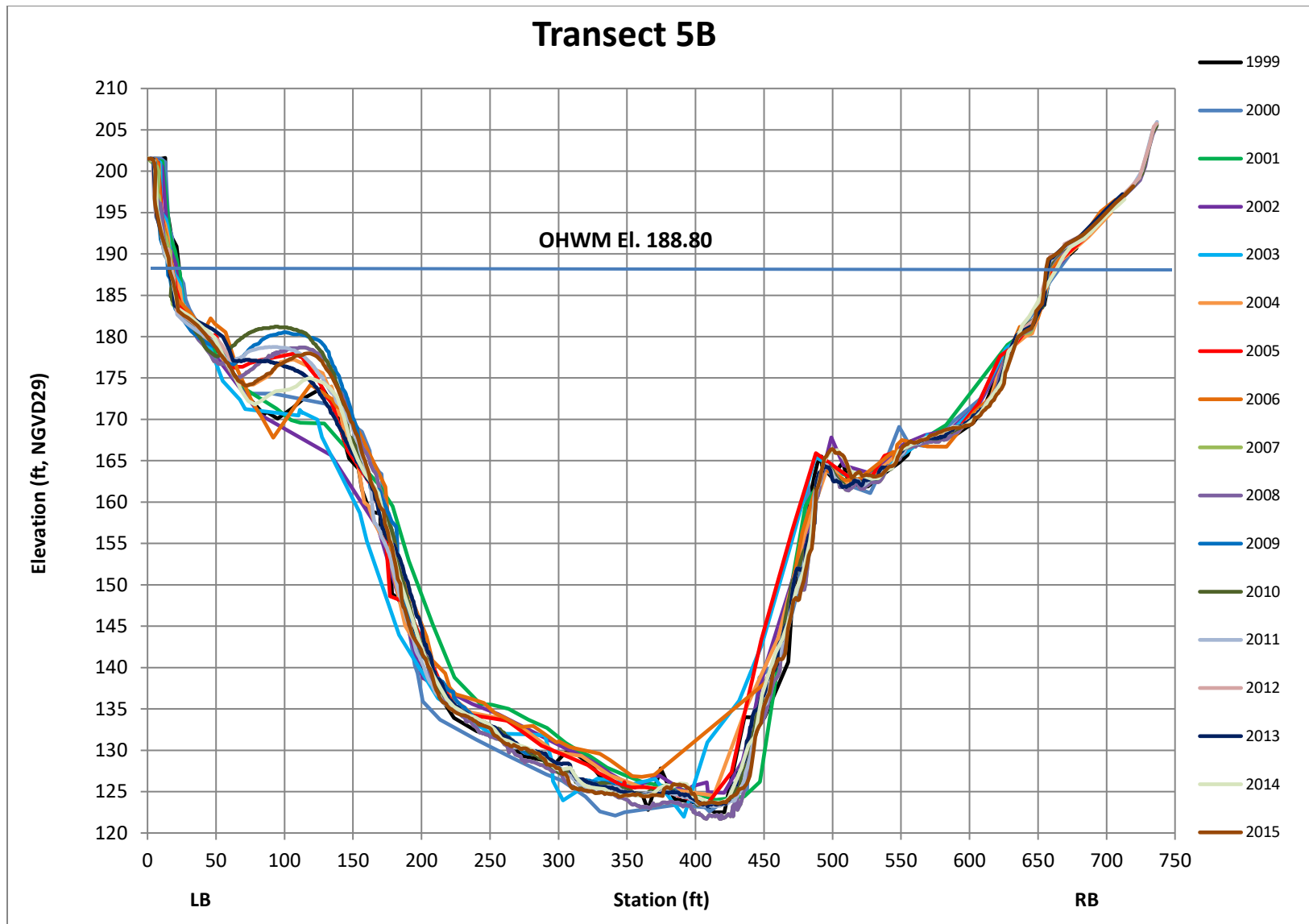


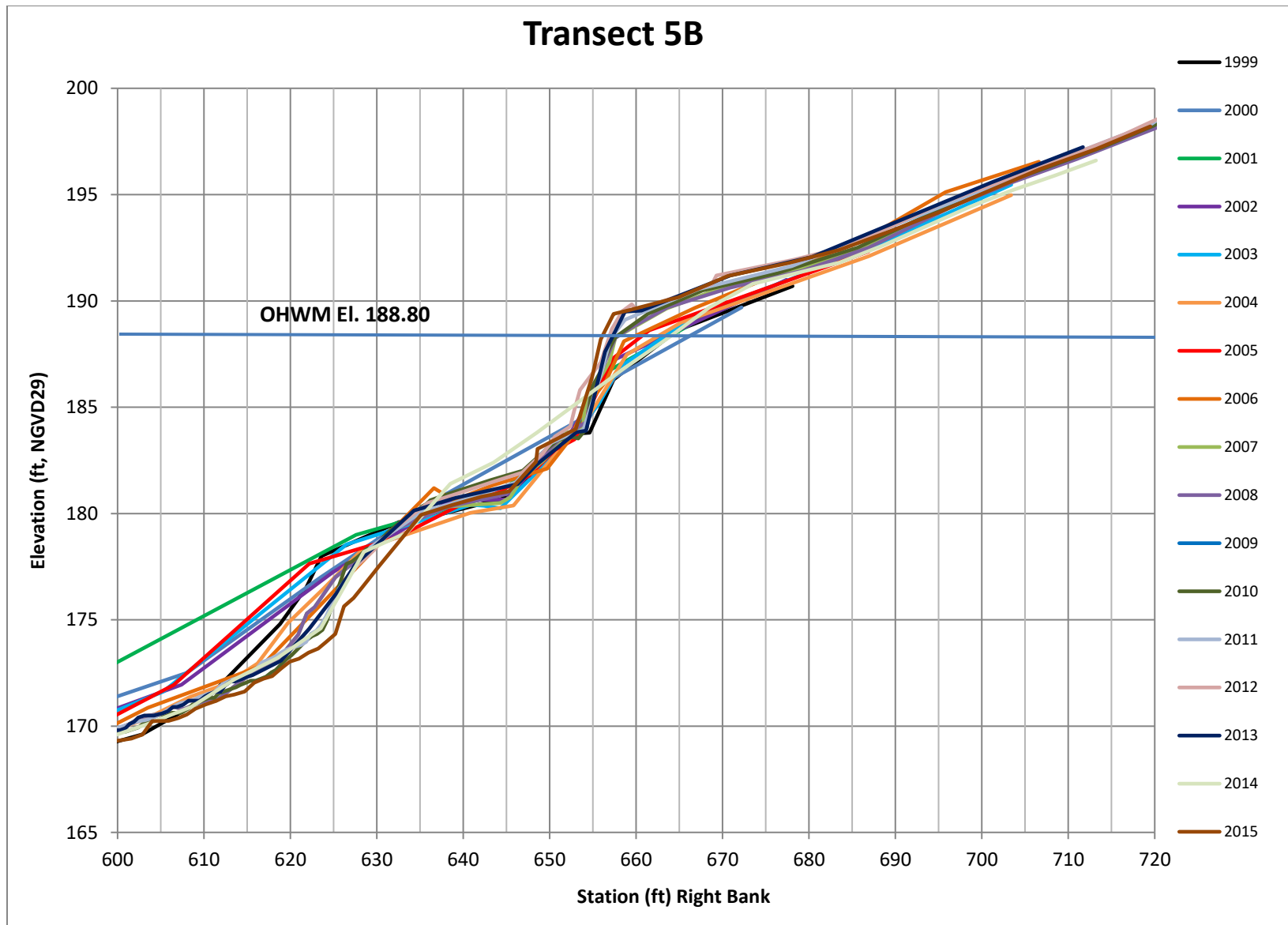


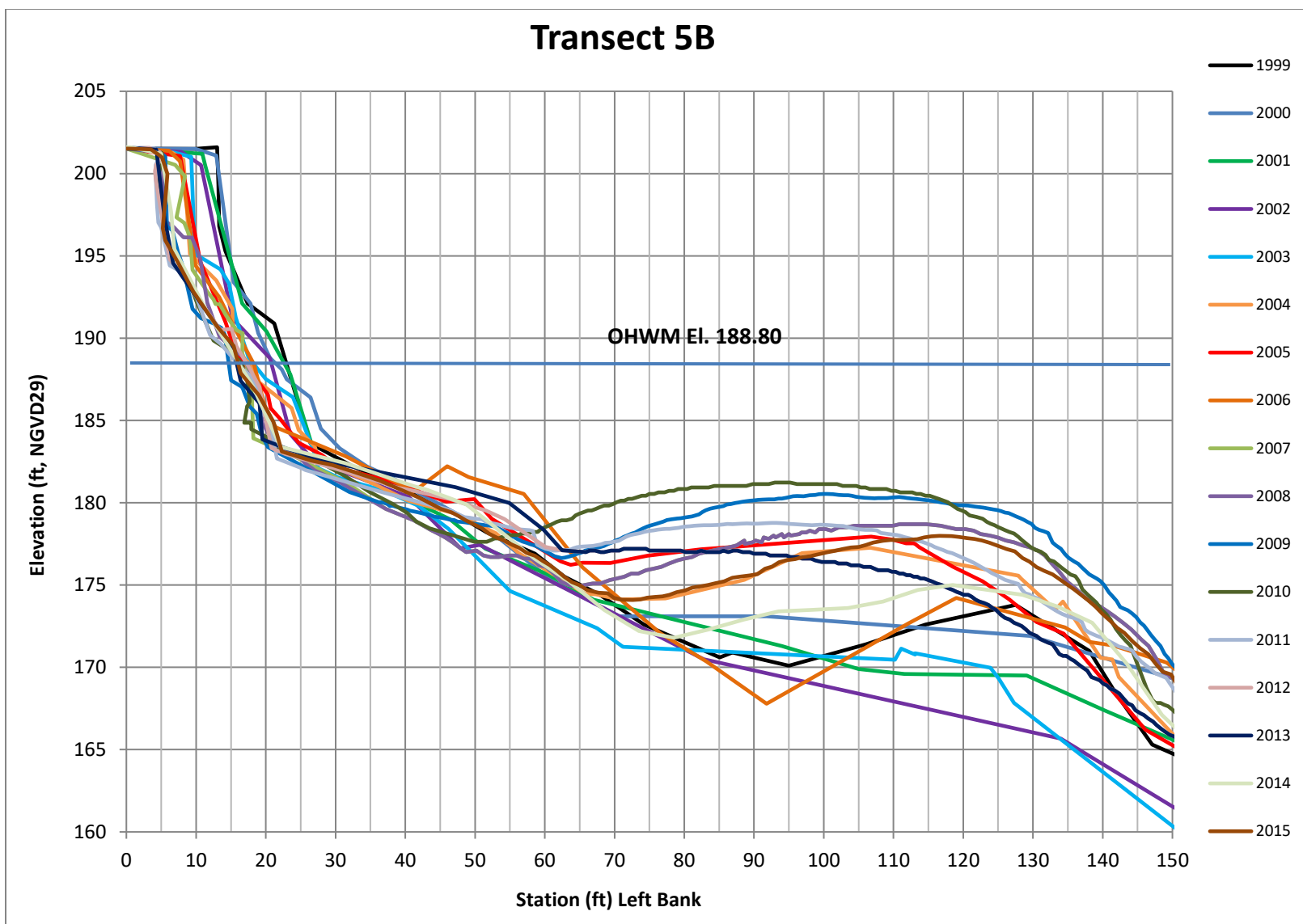




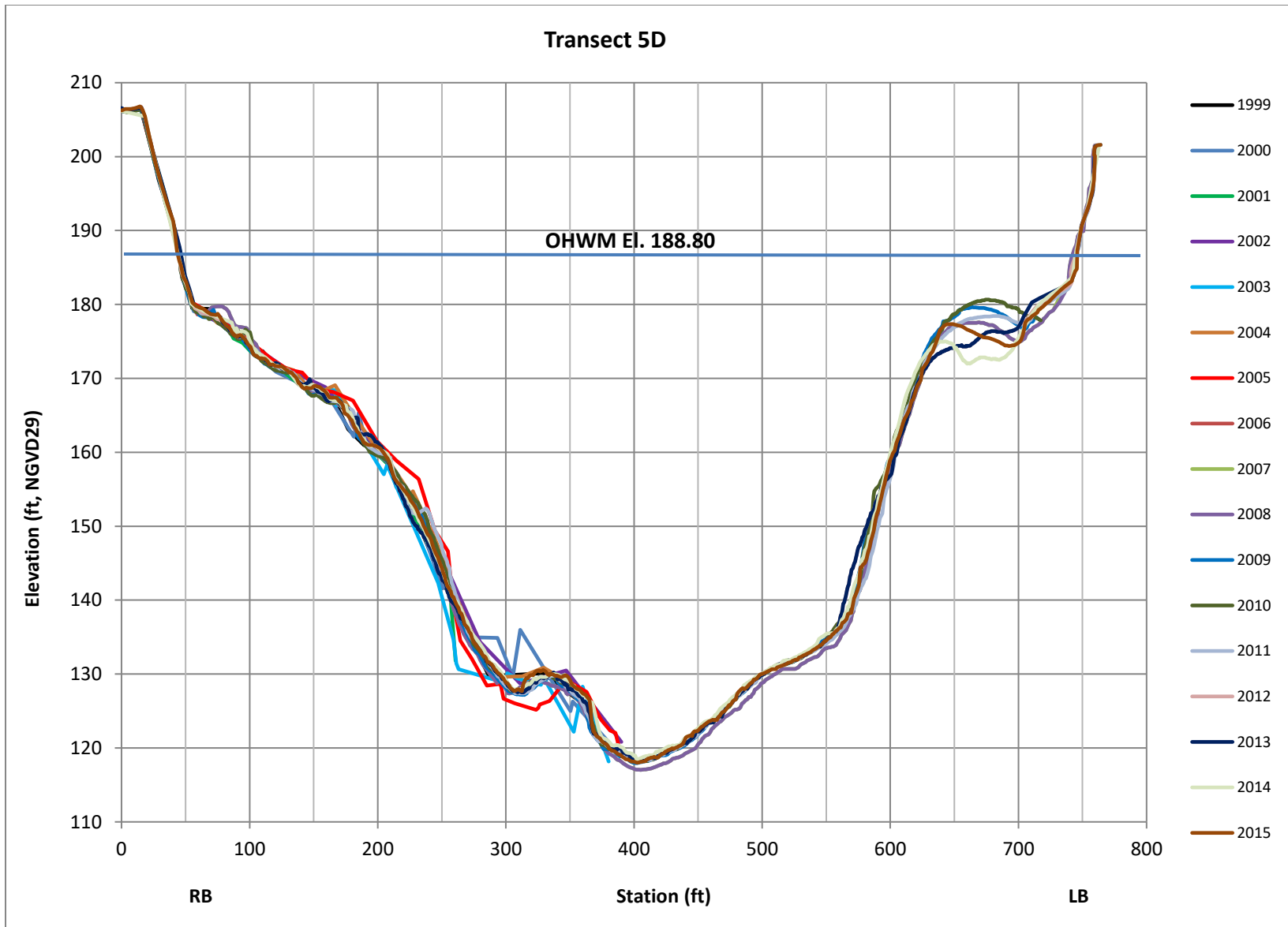




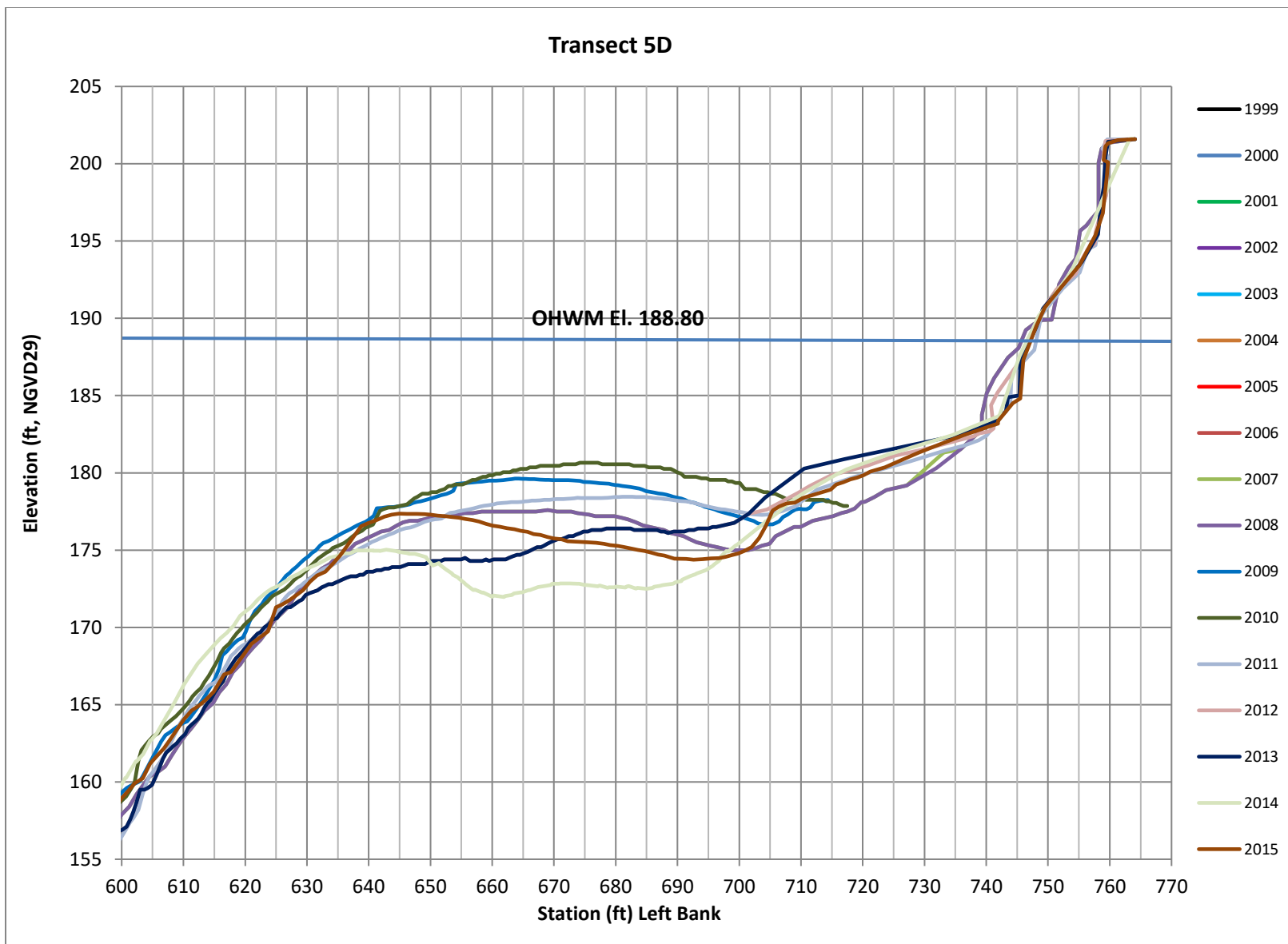




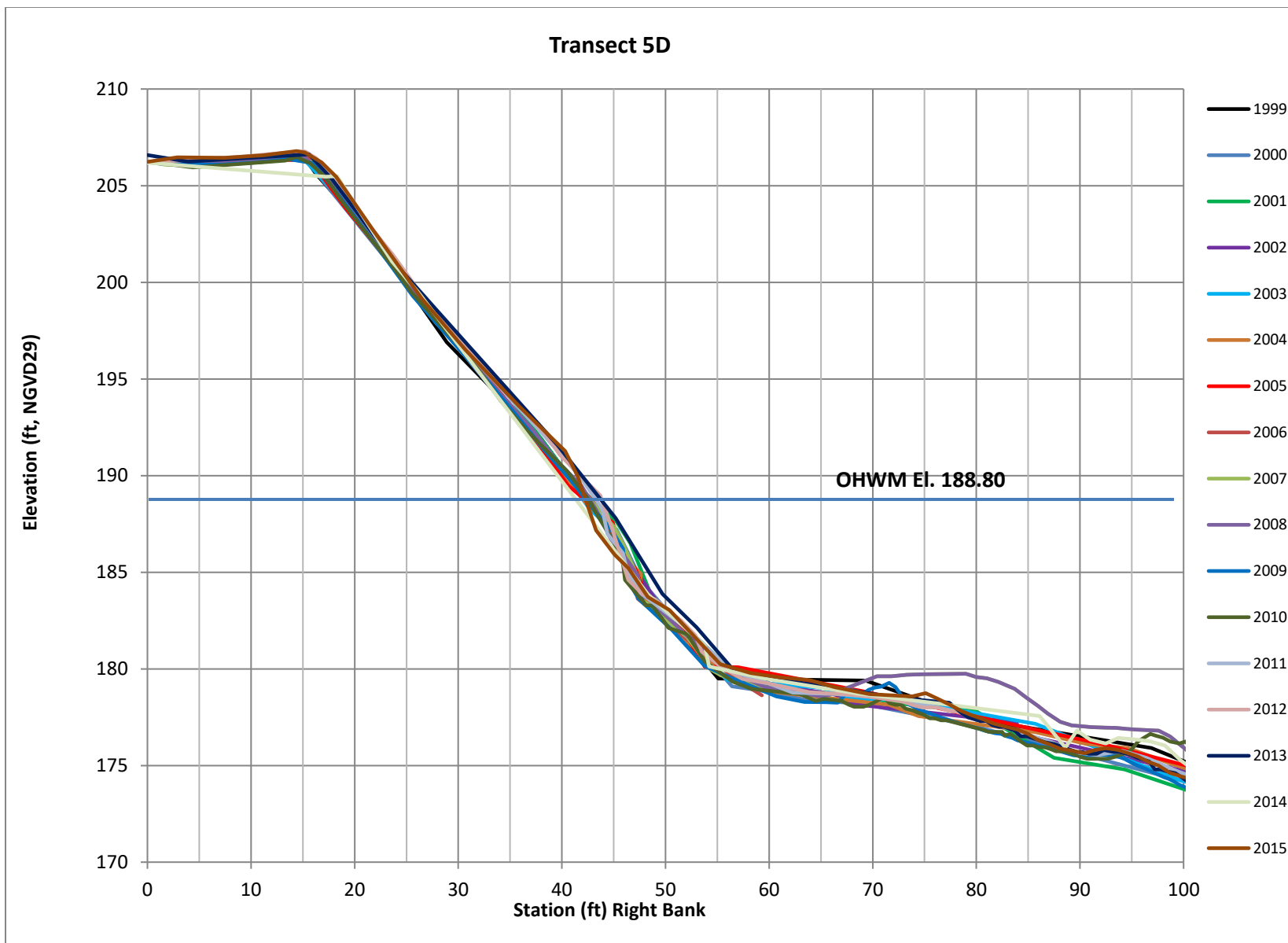
STUDY 3.1.2 NORTHFIELD MOUNTAIN / TURNERS FALLS OPERATIONS IMPACTS ON EXISTING EROSION AND POTENTIAL BANK INSTABILITY



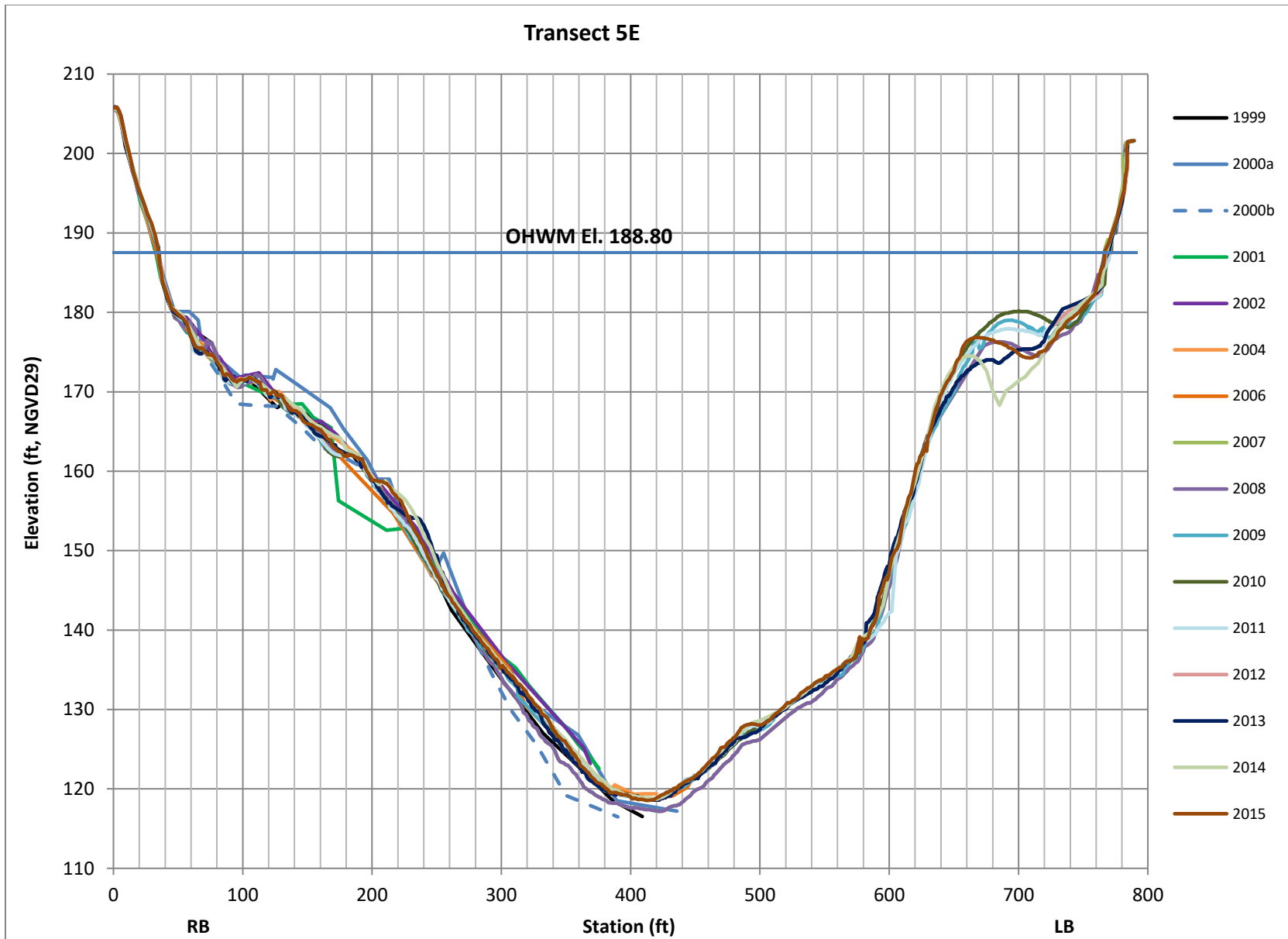


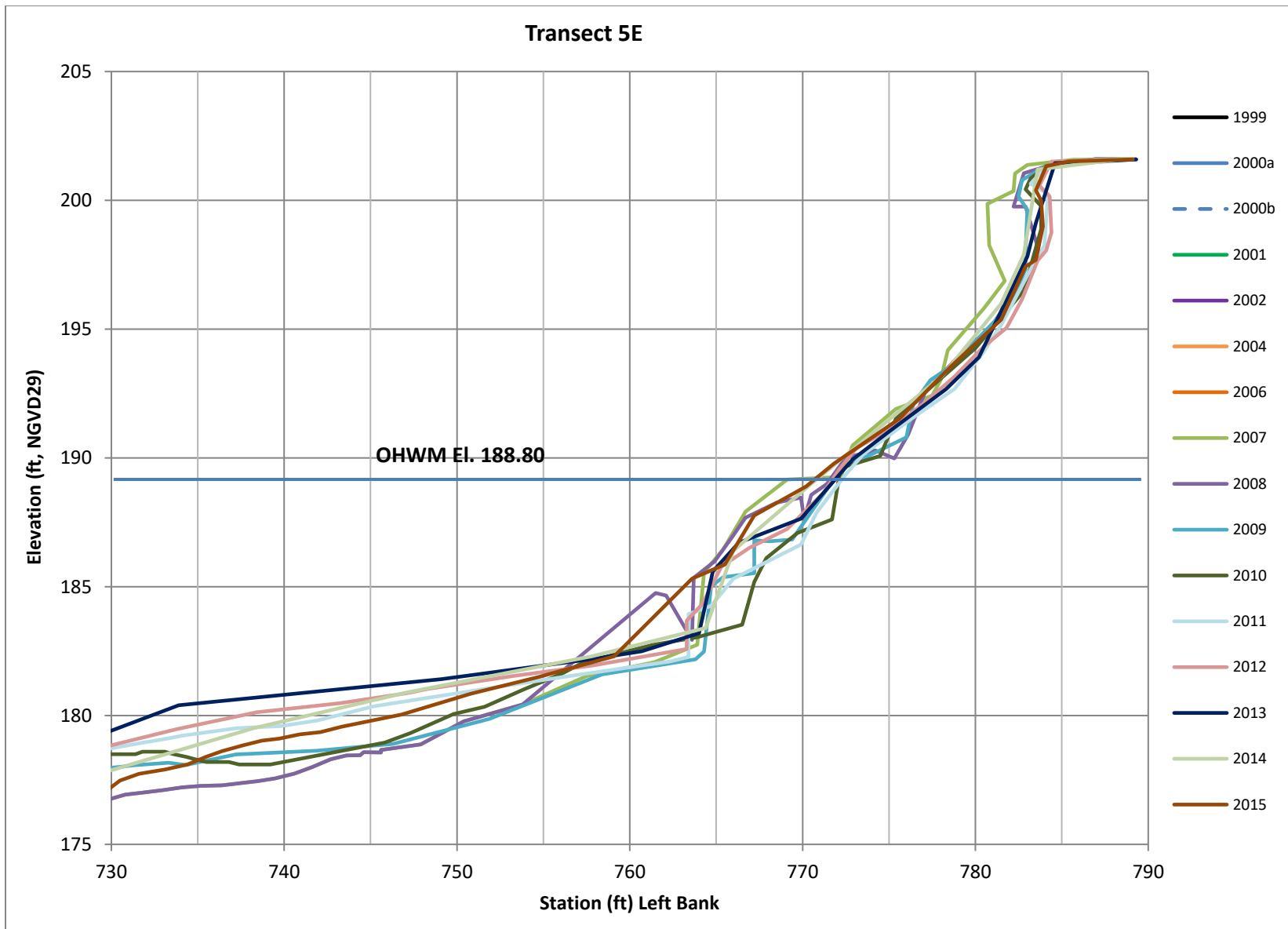


STUDY 3.1.2 NORTHFIELD MOUNTAIN / TURNERS FALLS OPERATIONS IMPACTS ON EXISTING EROSION AND POTENTIAL BANK INSTABILITY

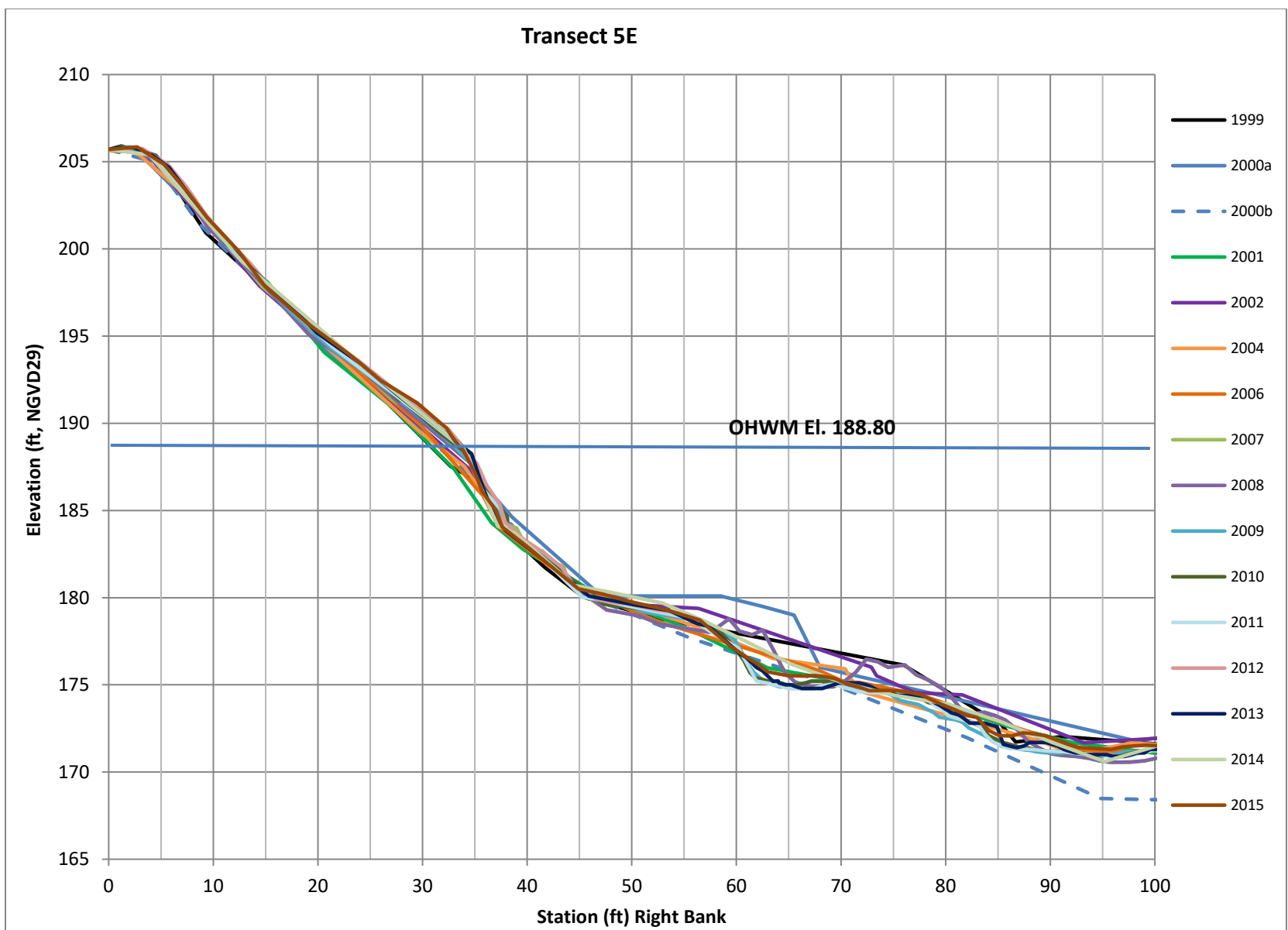


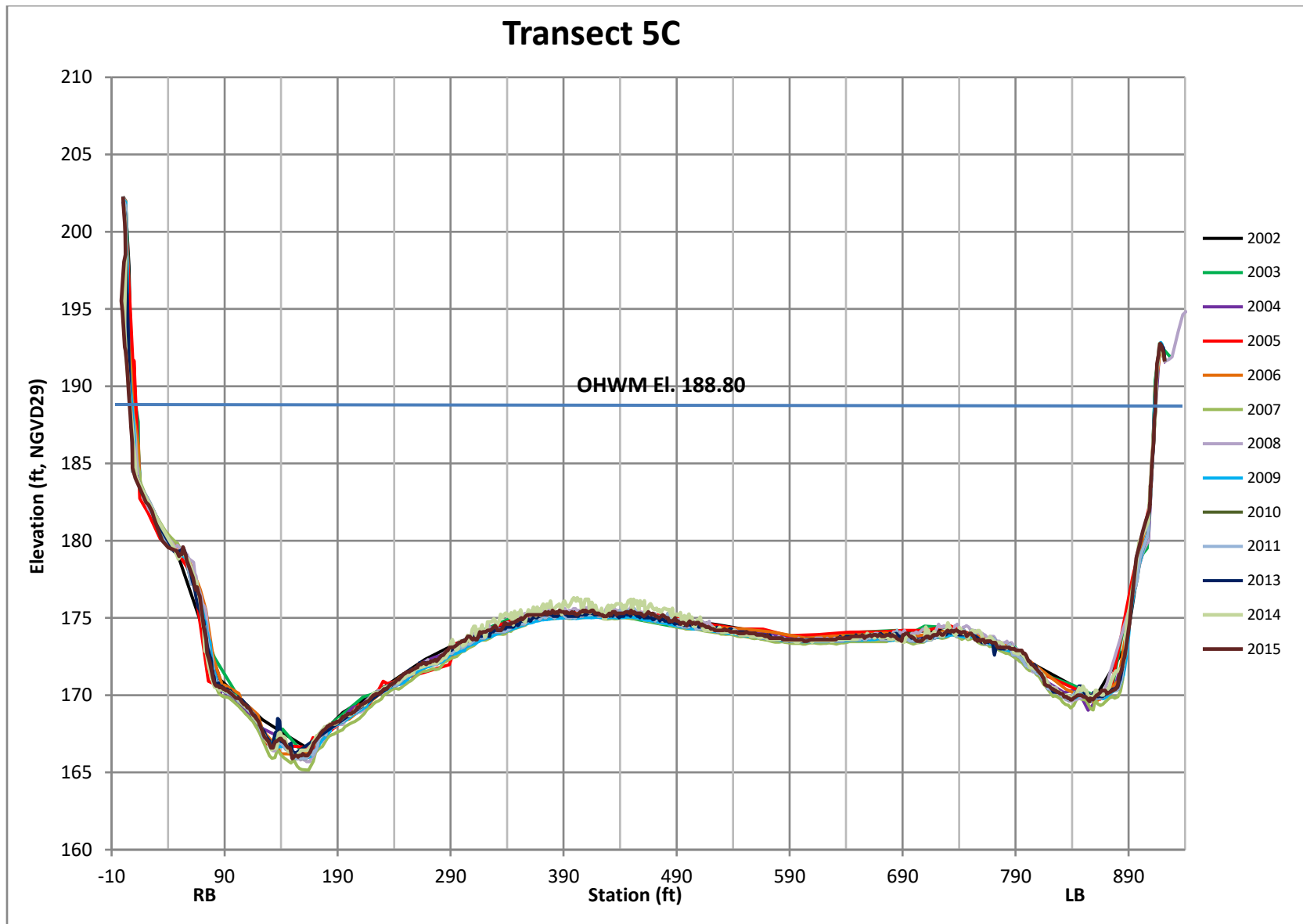
STUDY 3.1.2 NORTHFIELD MOUNTAIN / TURNERS FALLS OPERATIONS IMPACTS ON EXISTING EROSION AND POTENTIAL BANK INSTABILITY

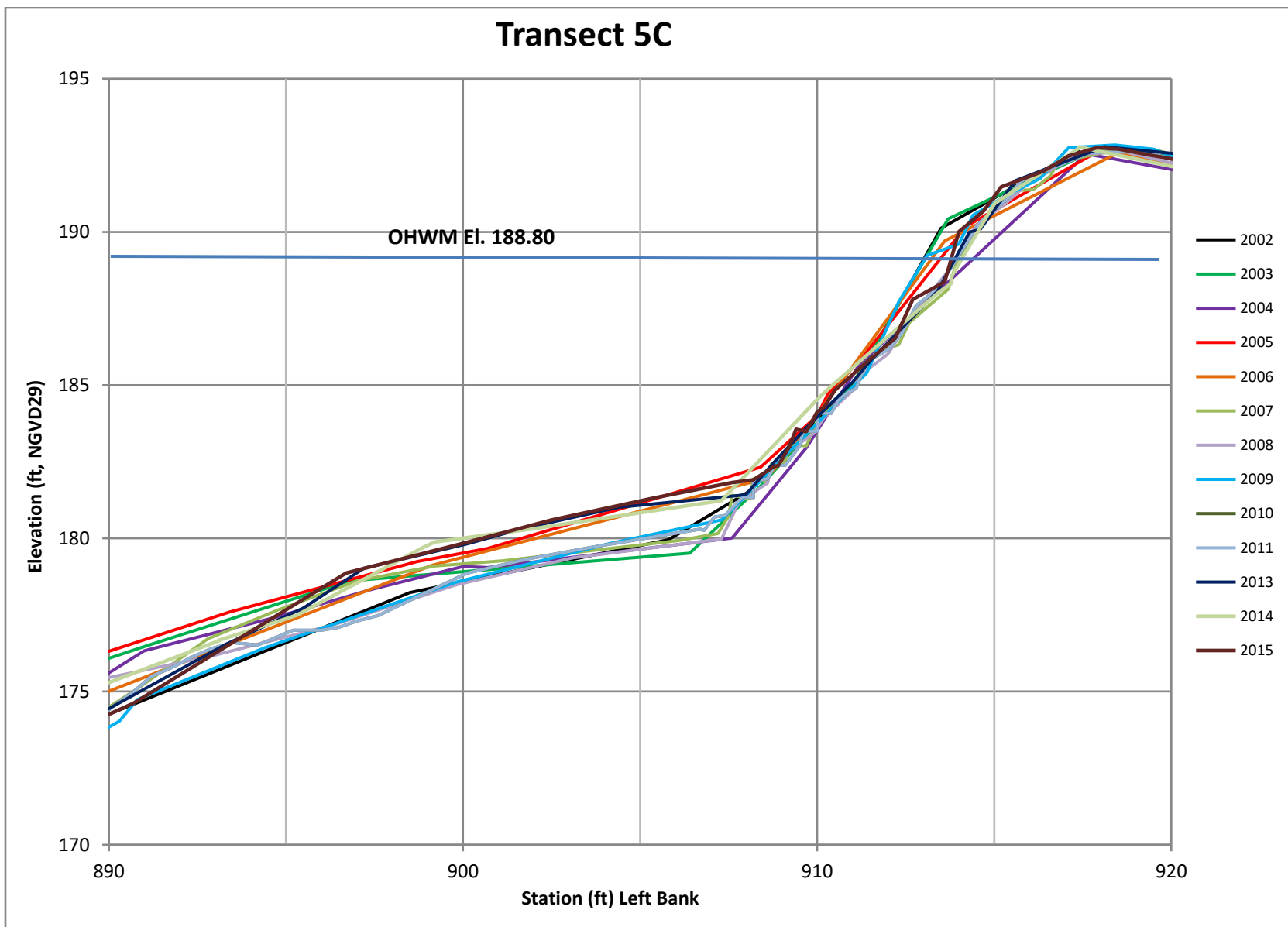


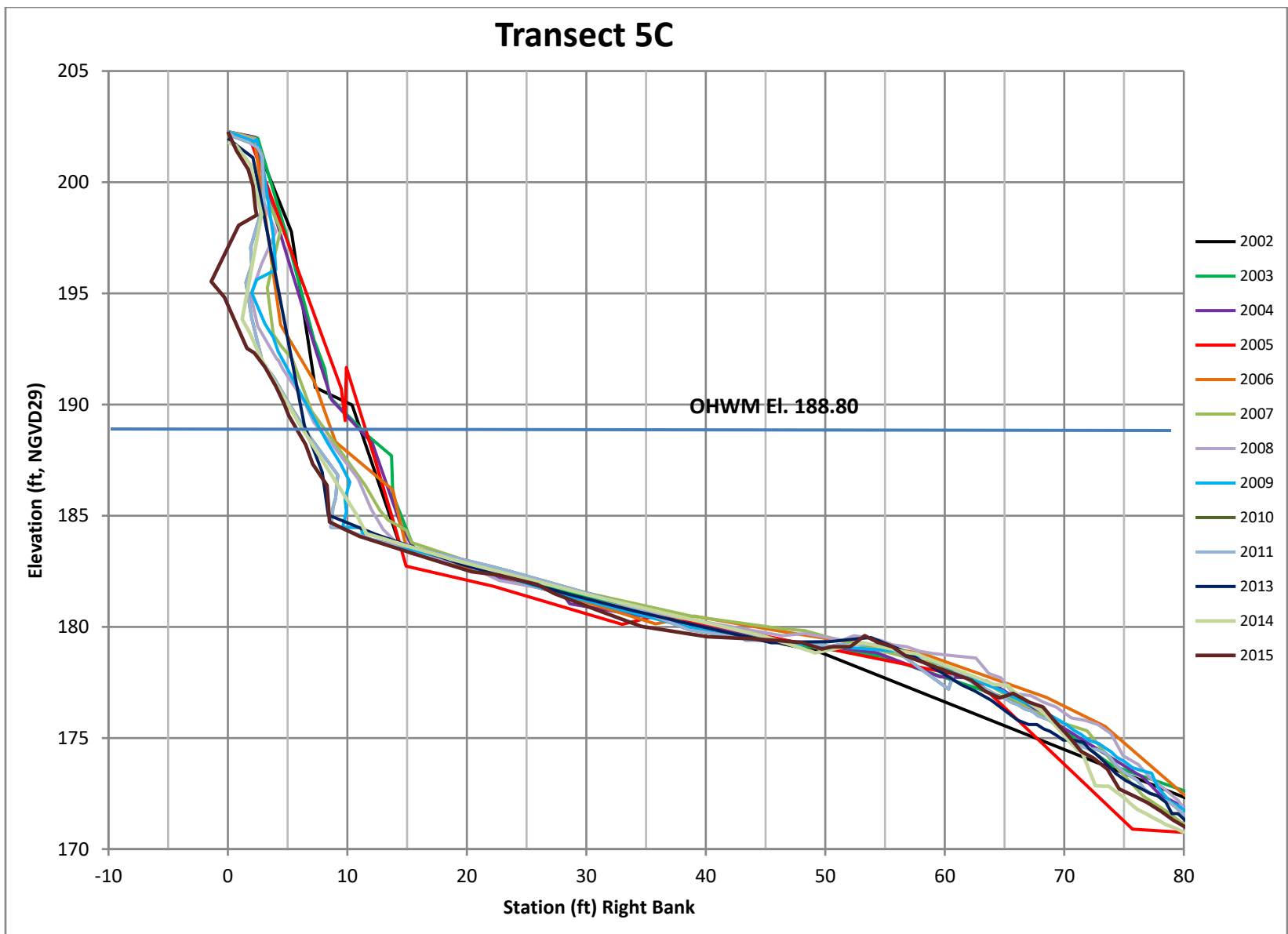


STUDY 3.1.2 NORTHFIELD MOUNTAIN / TURNERS FALLS OPERATIONS IMPACTS ON EXISTING EROSION AND POTENTIAL BANK INSTABILITY

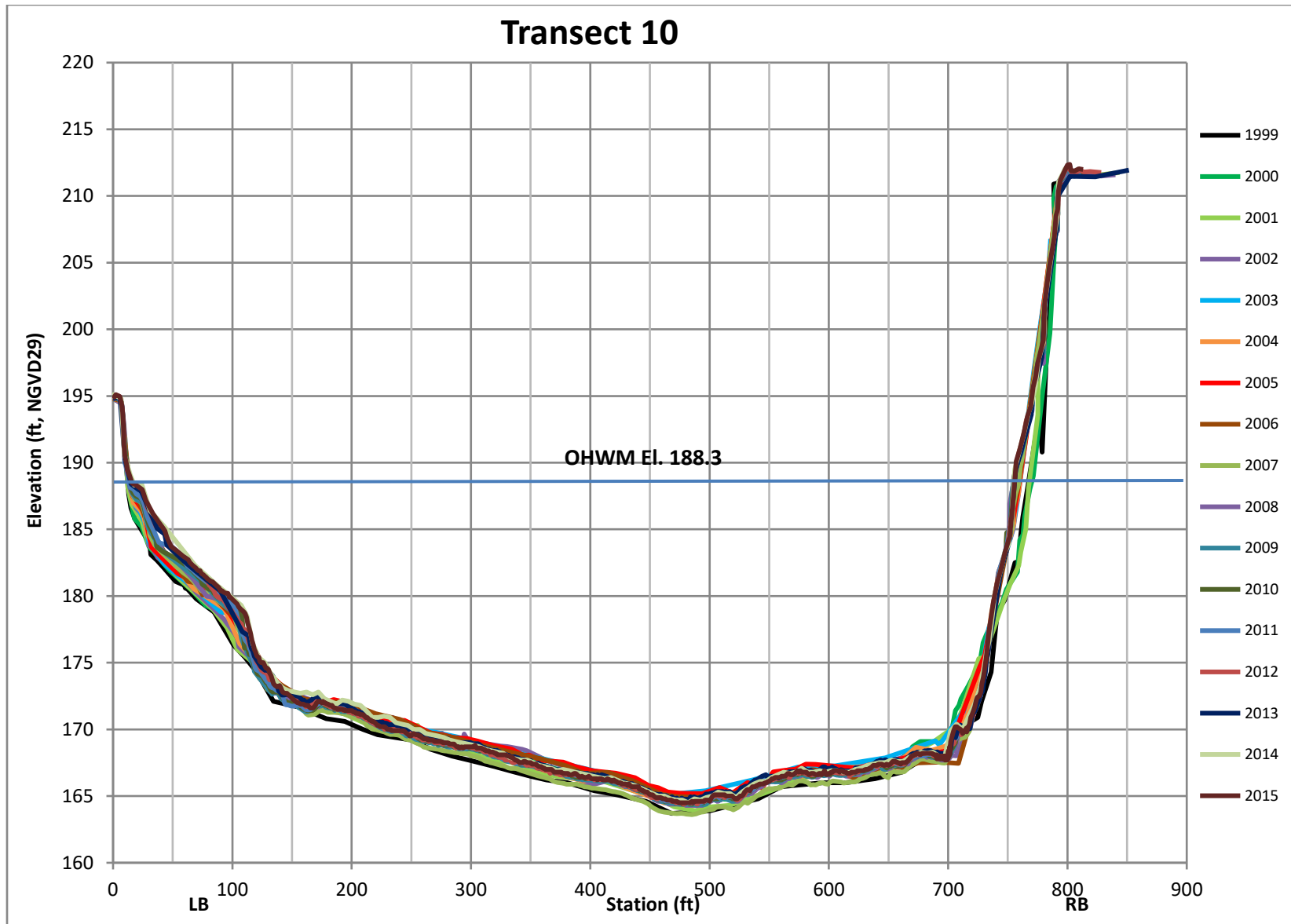


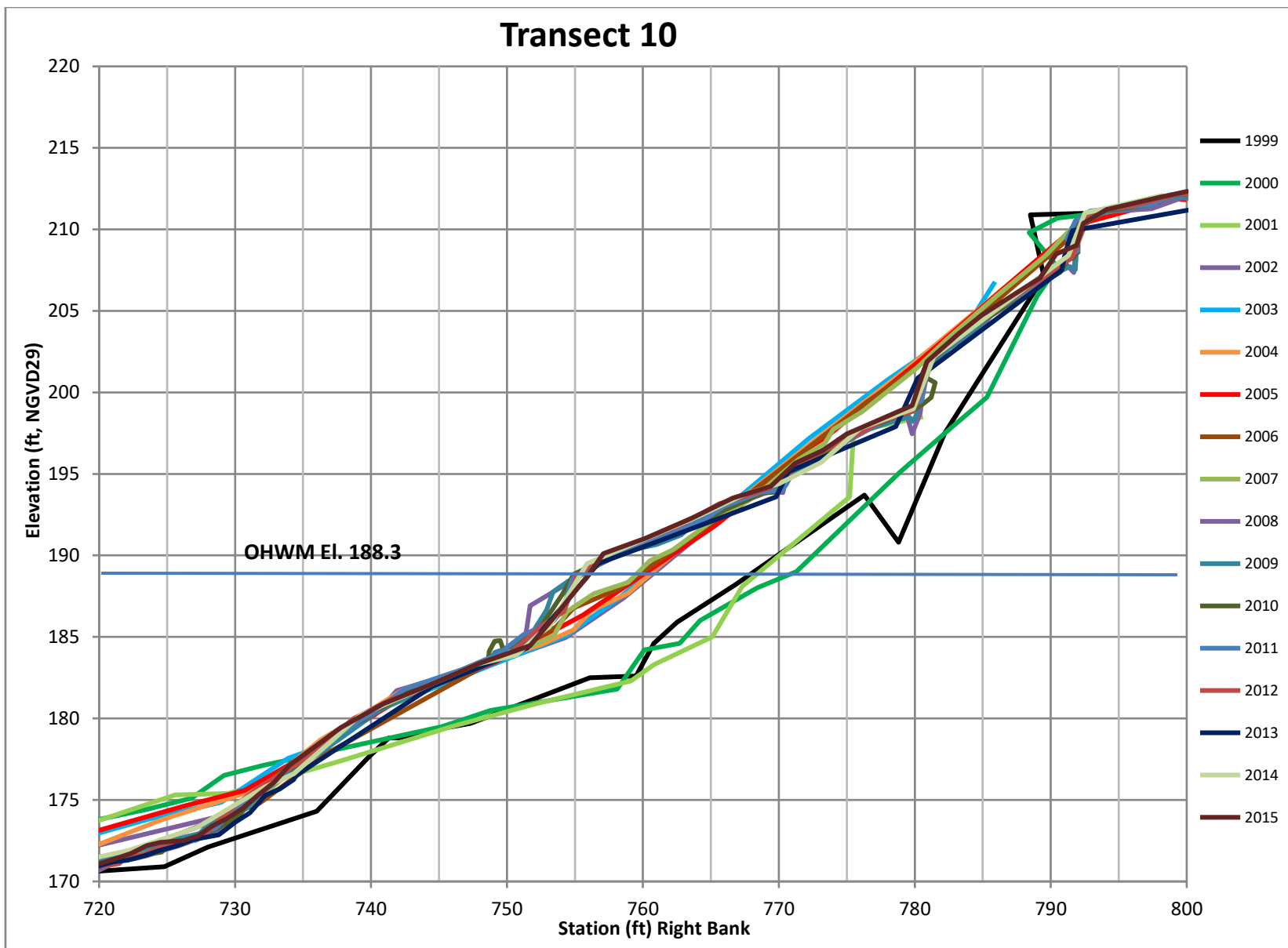


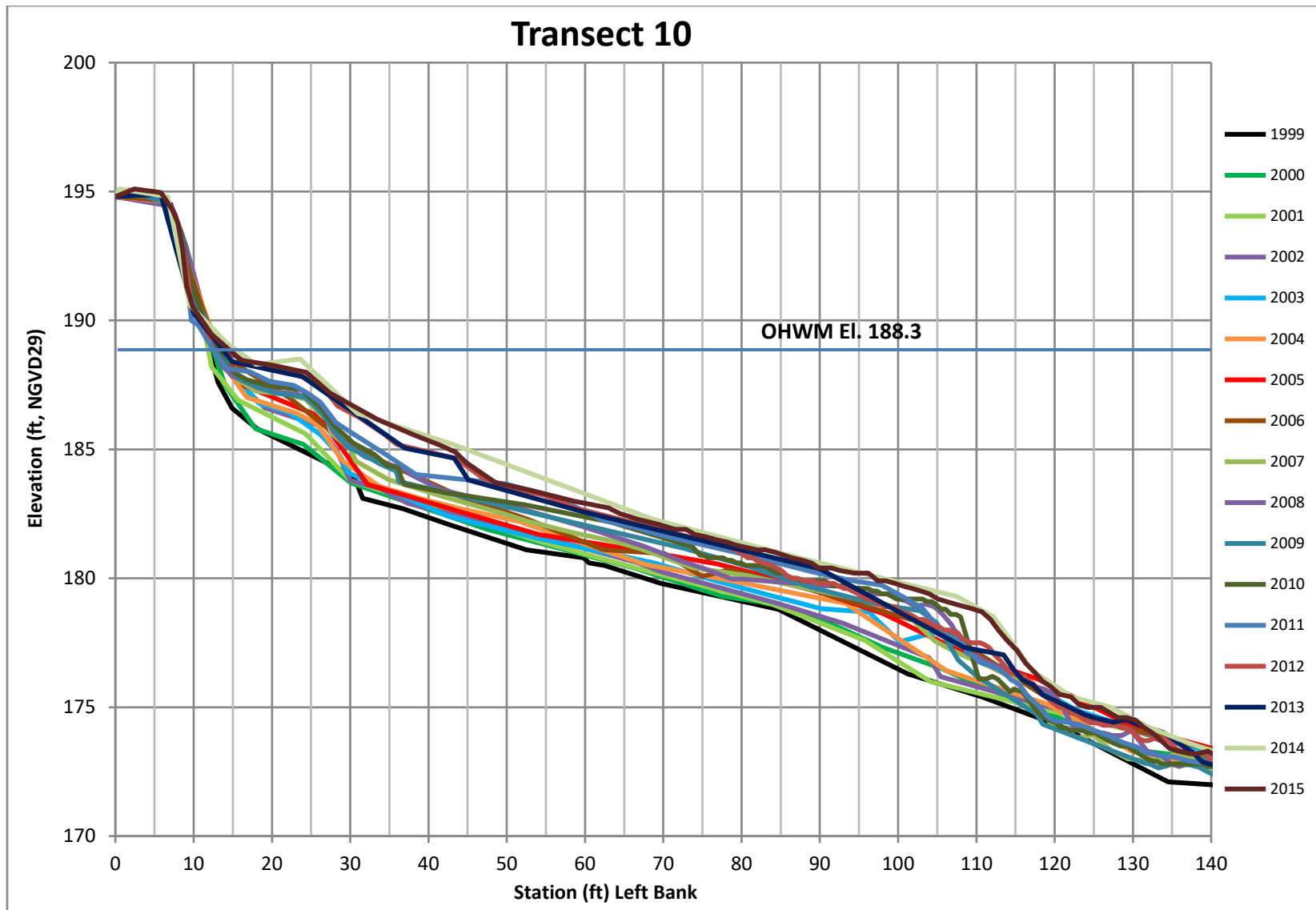


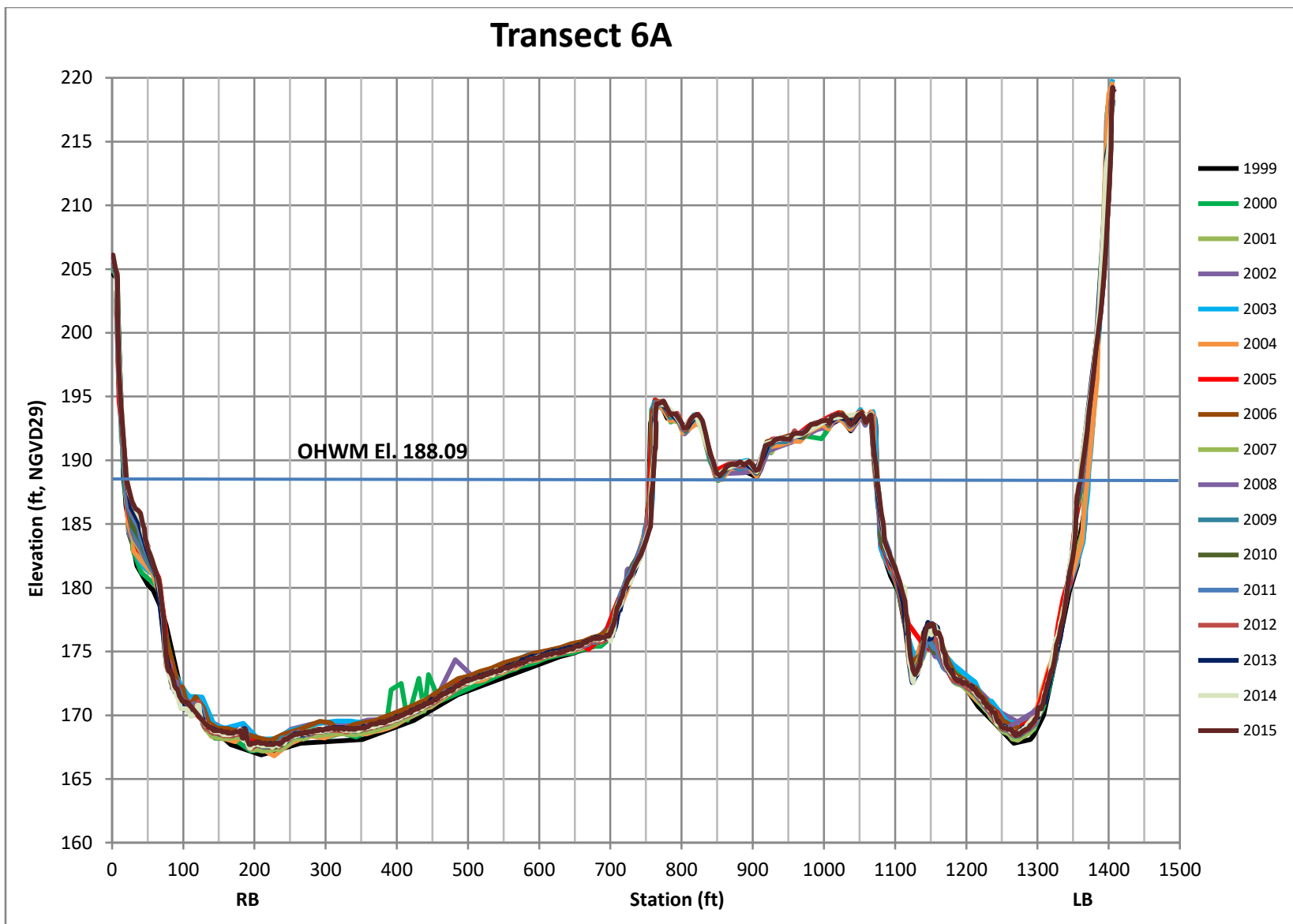


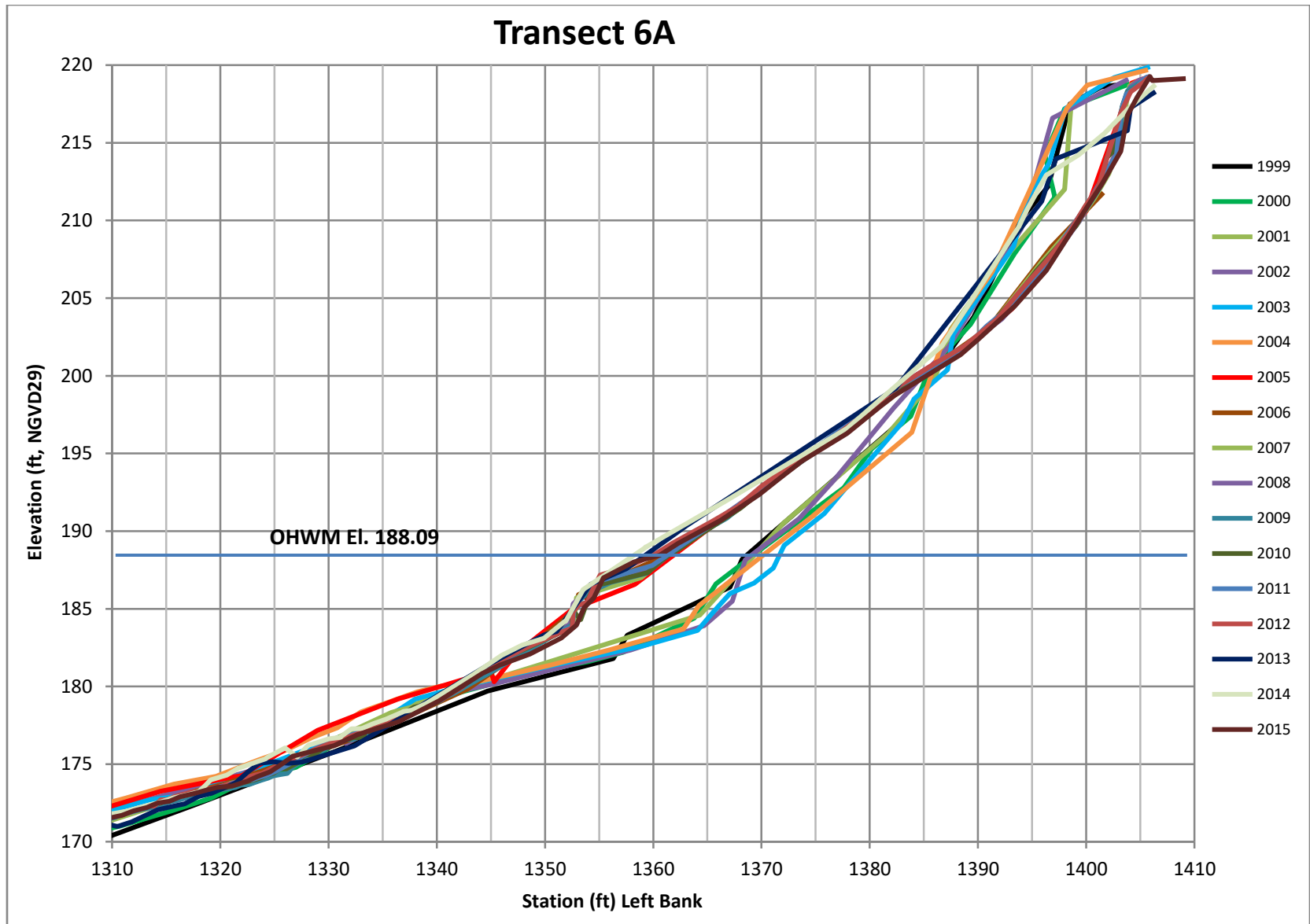


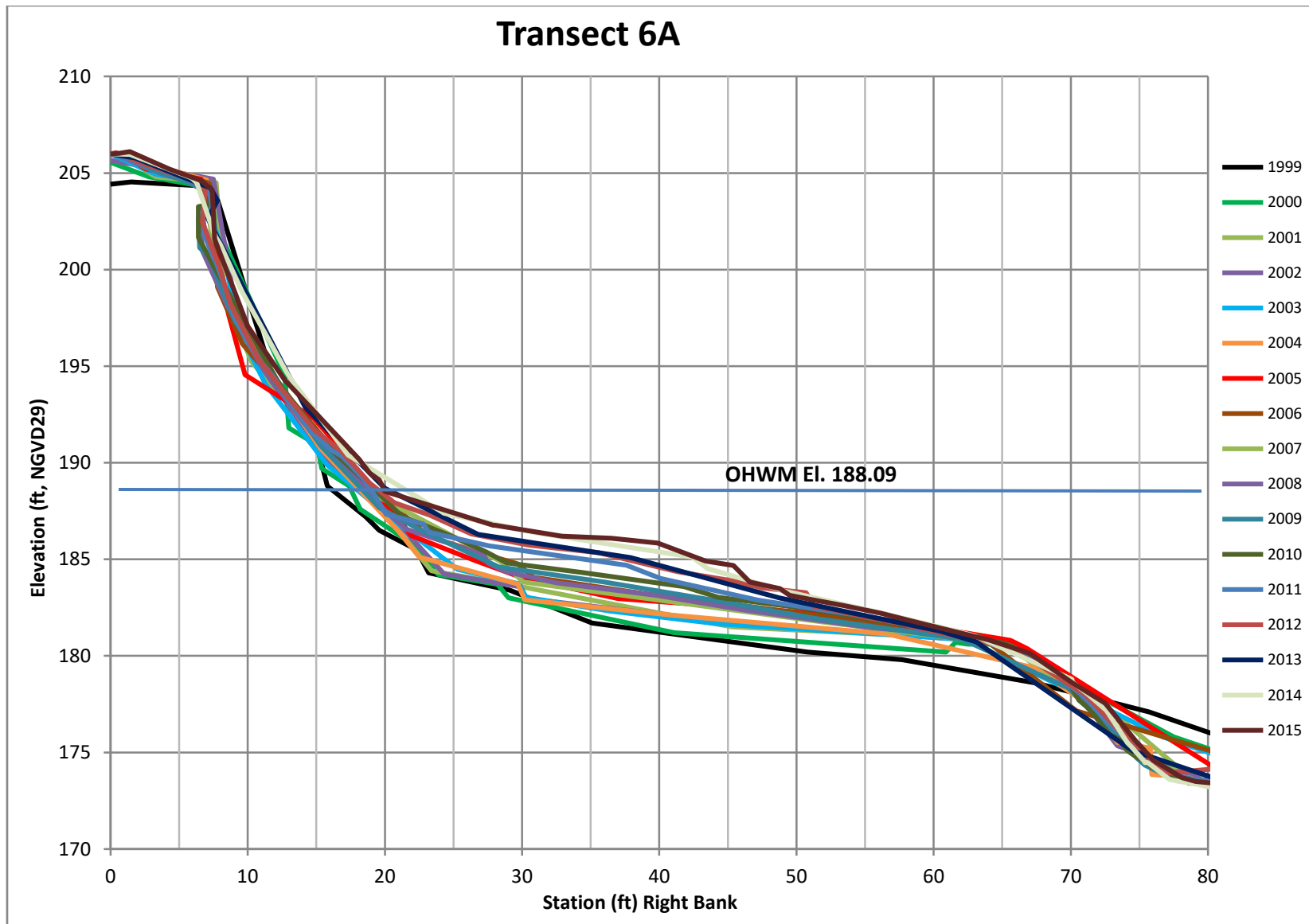


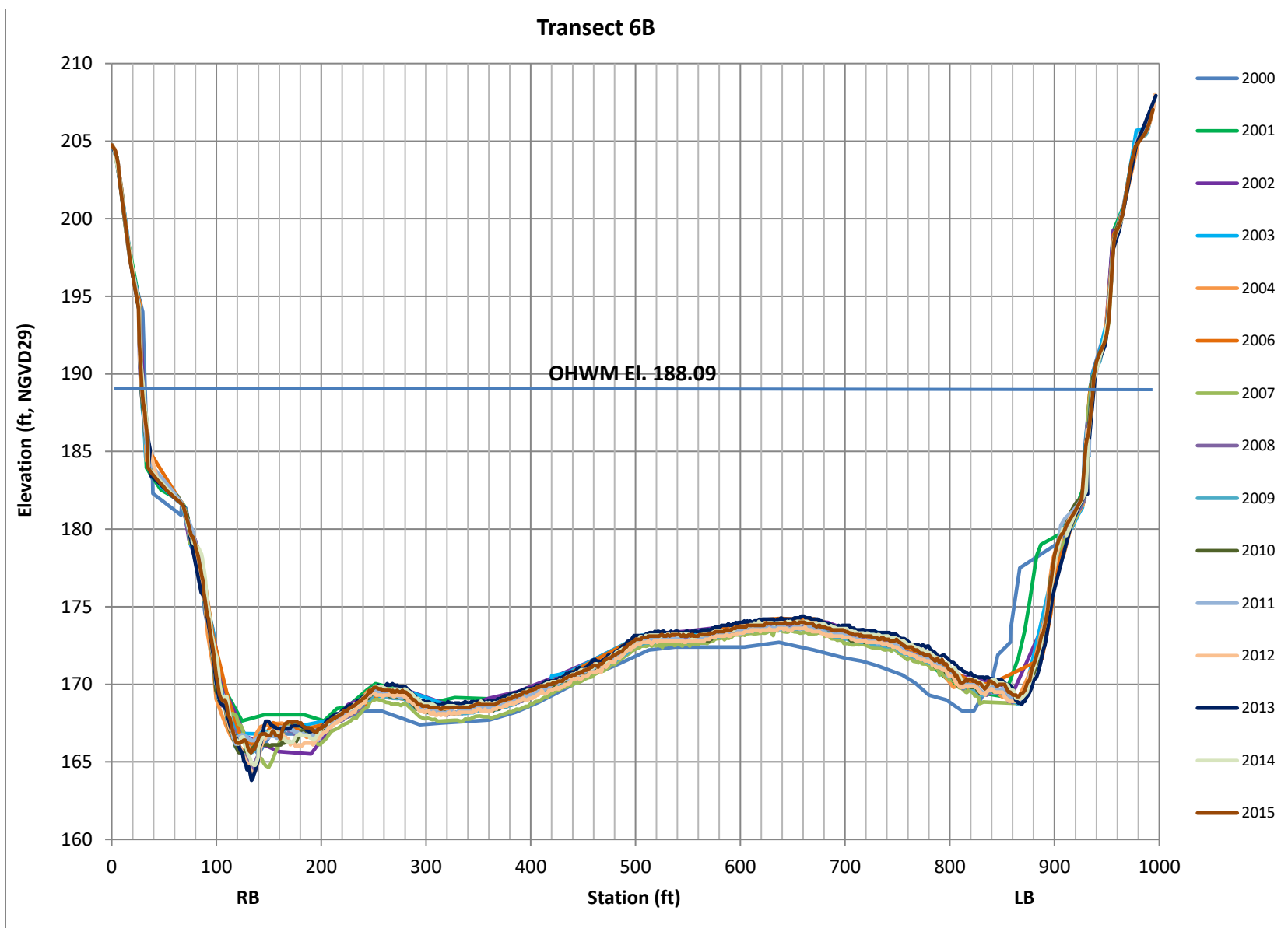


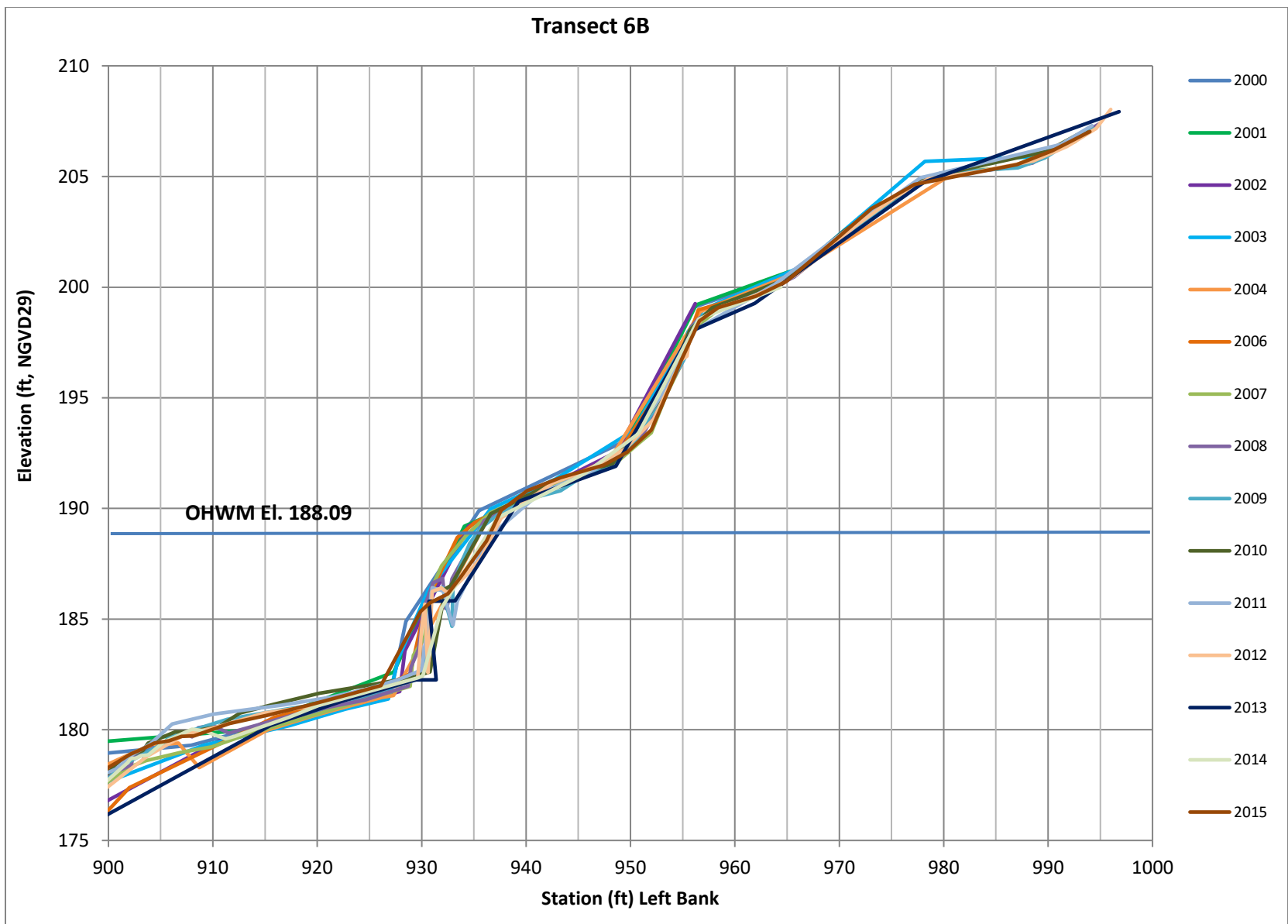




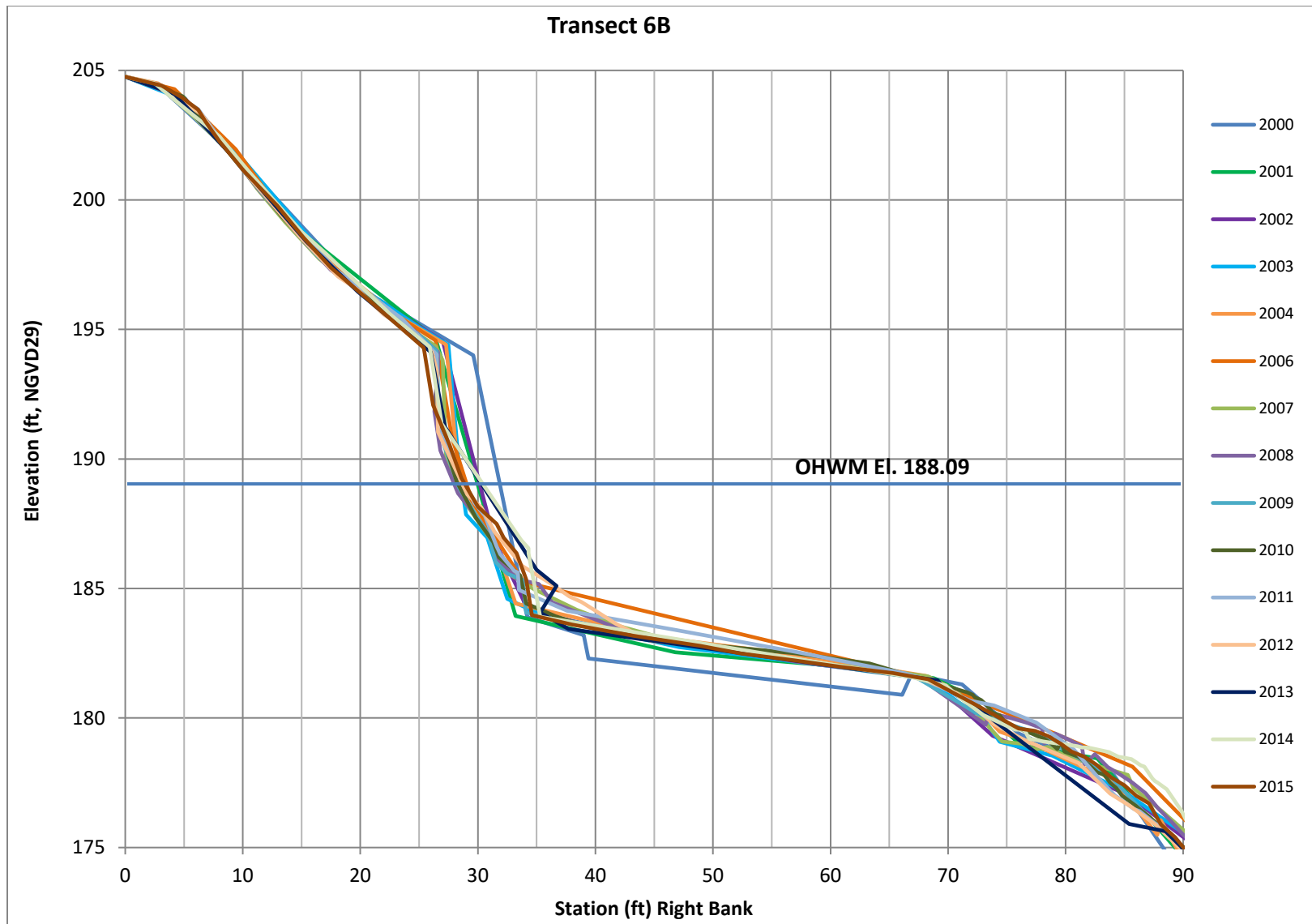


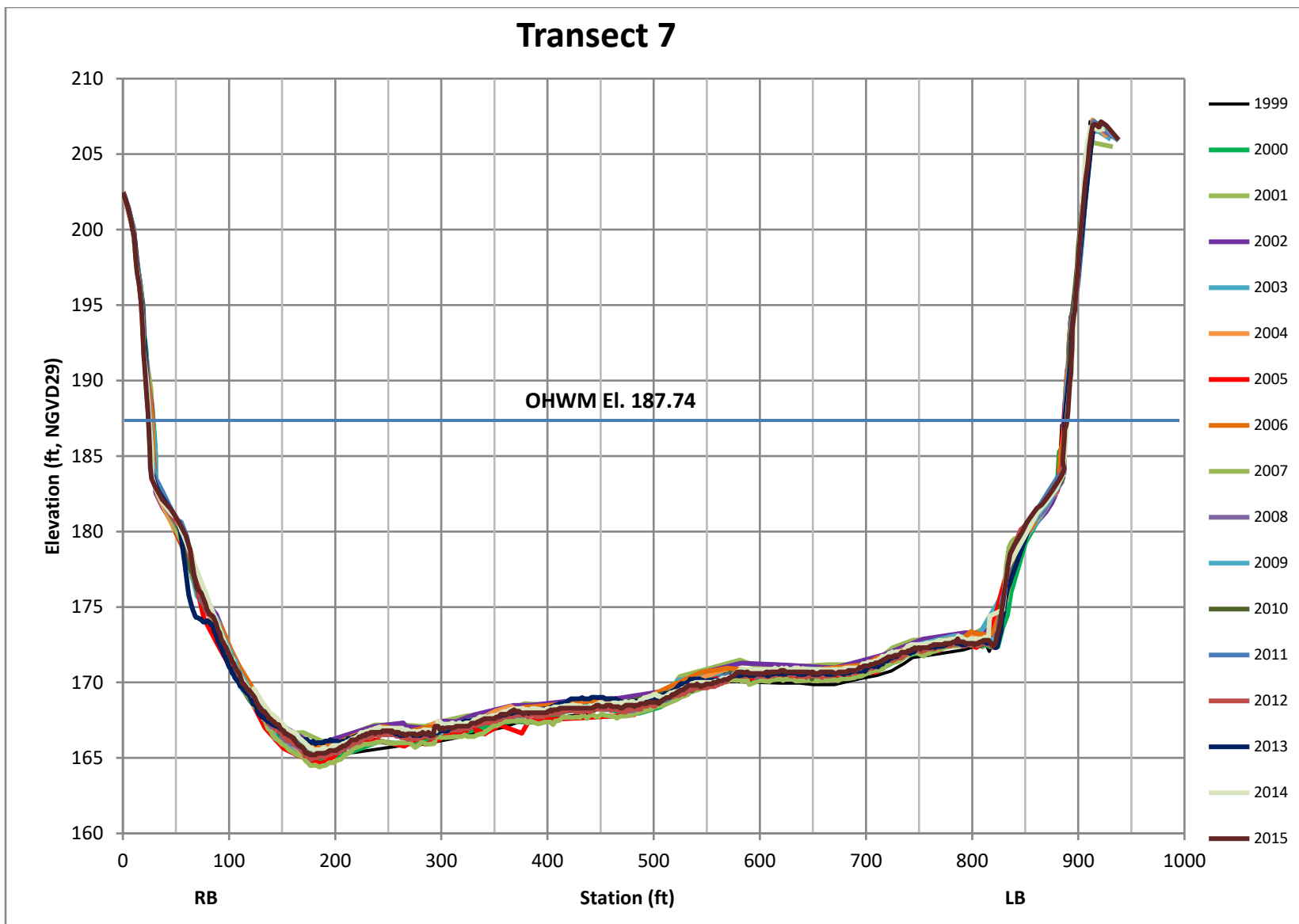


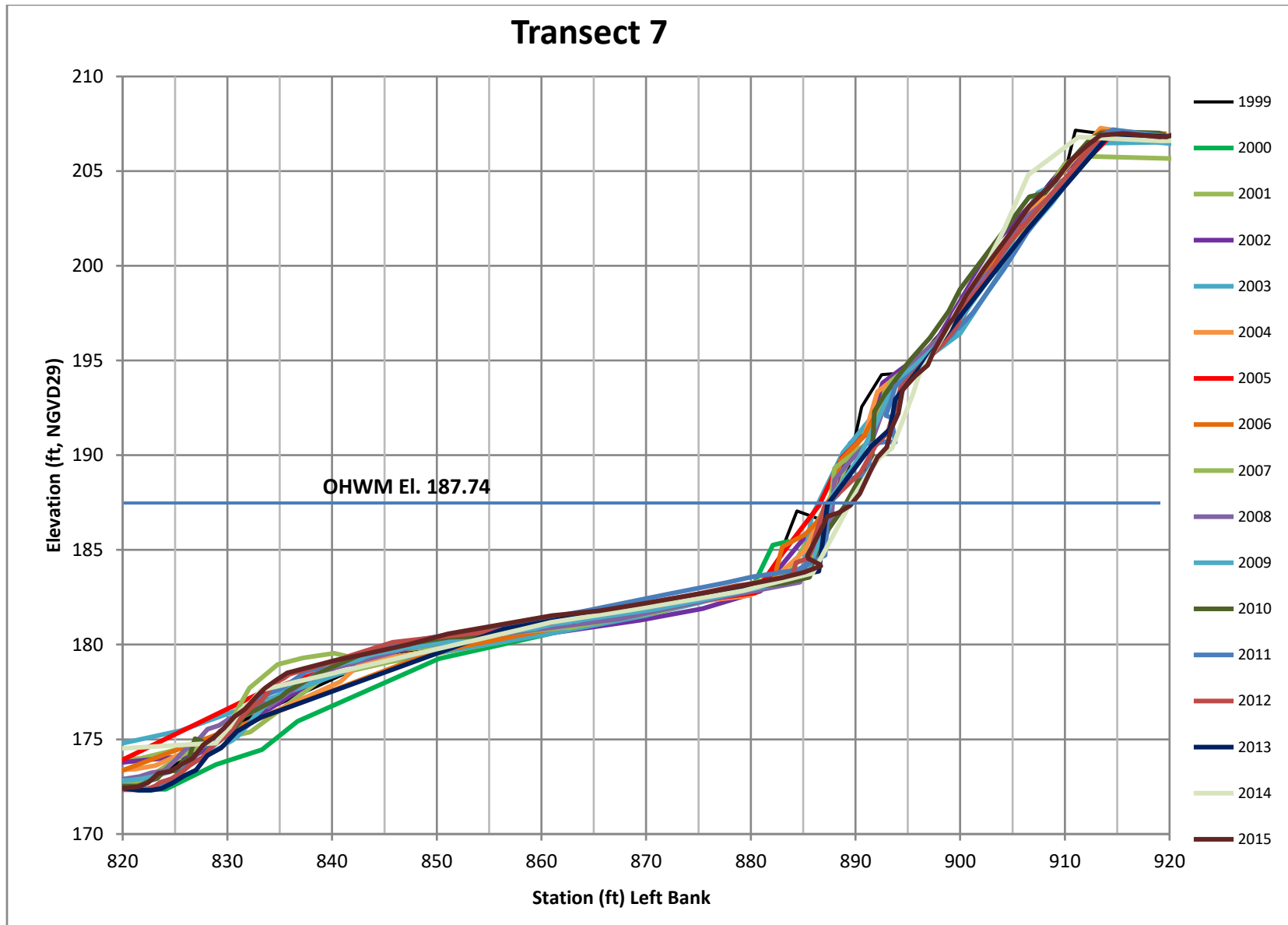


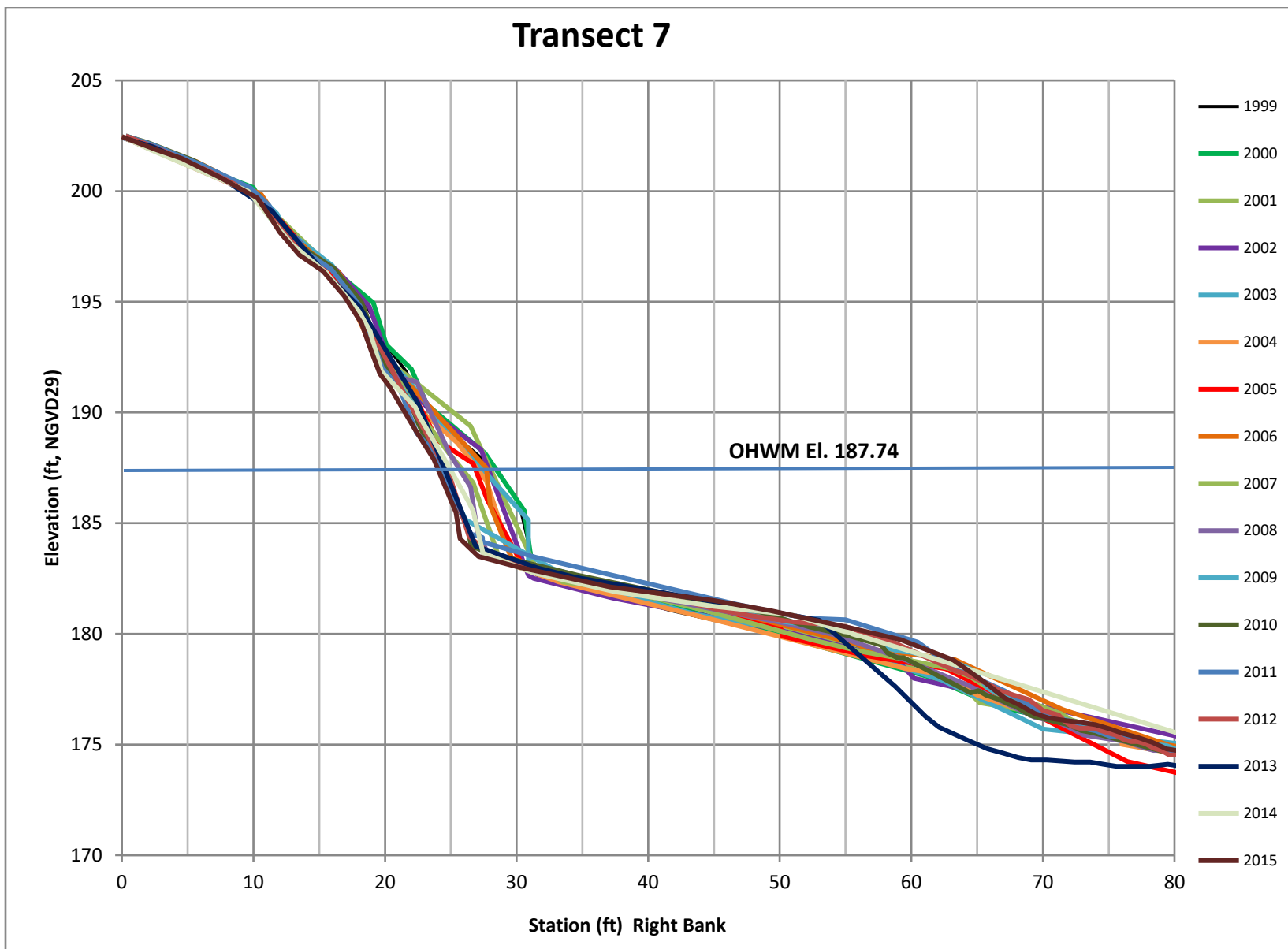


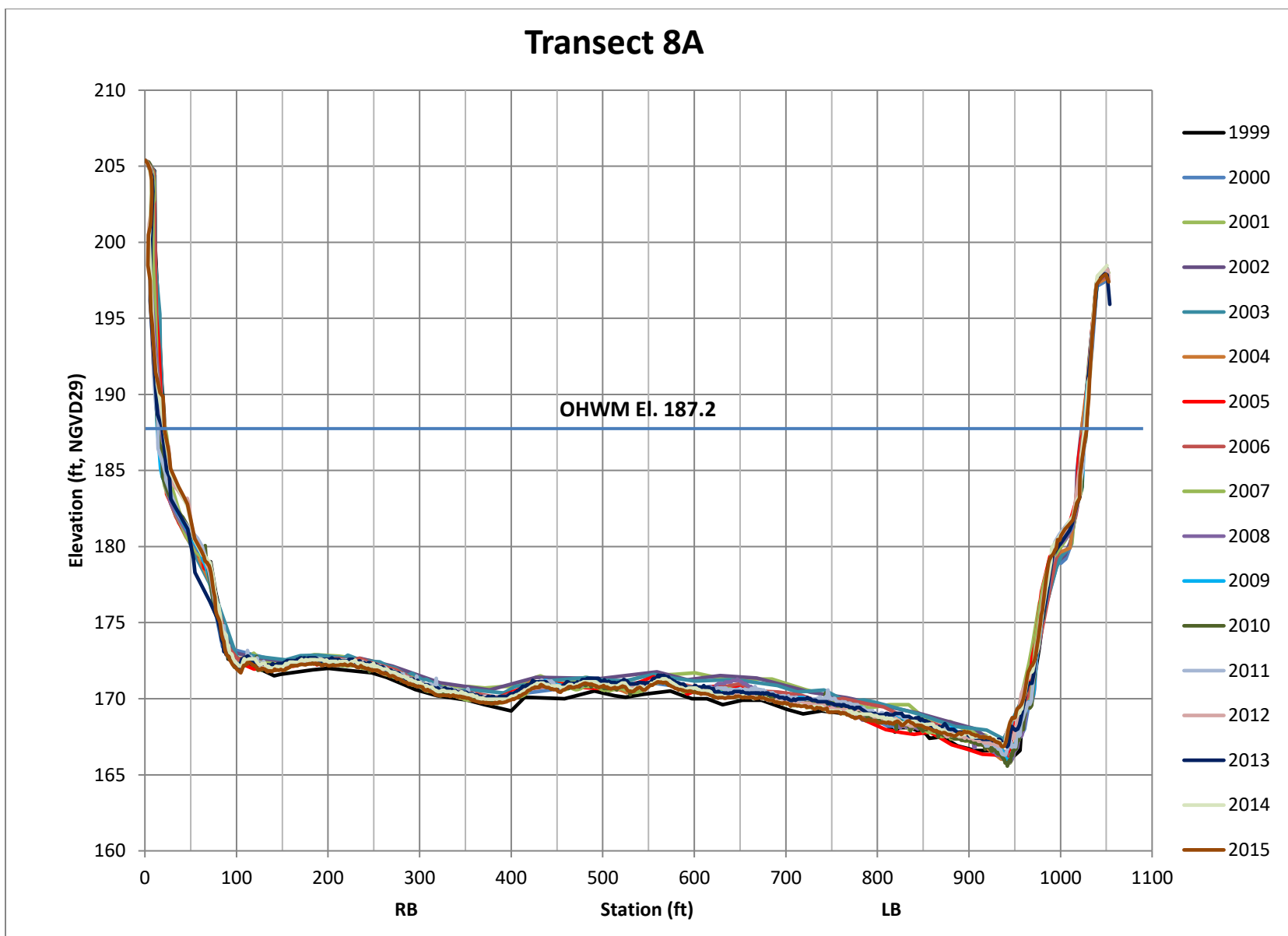


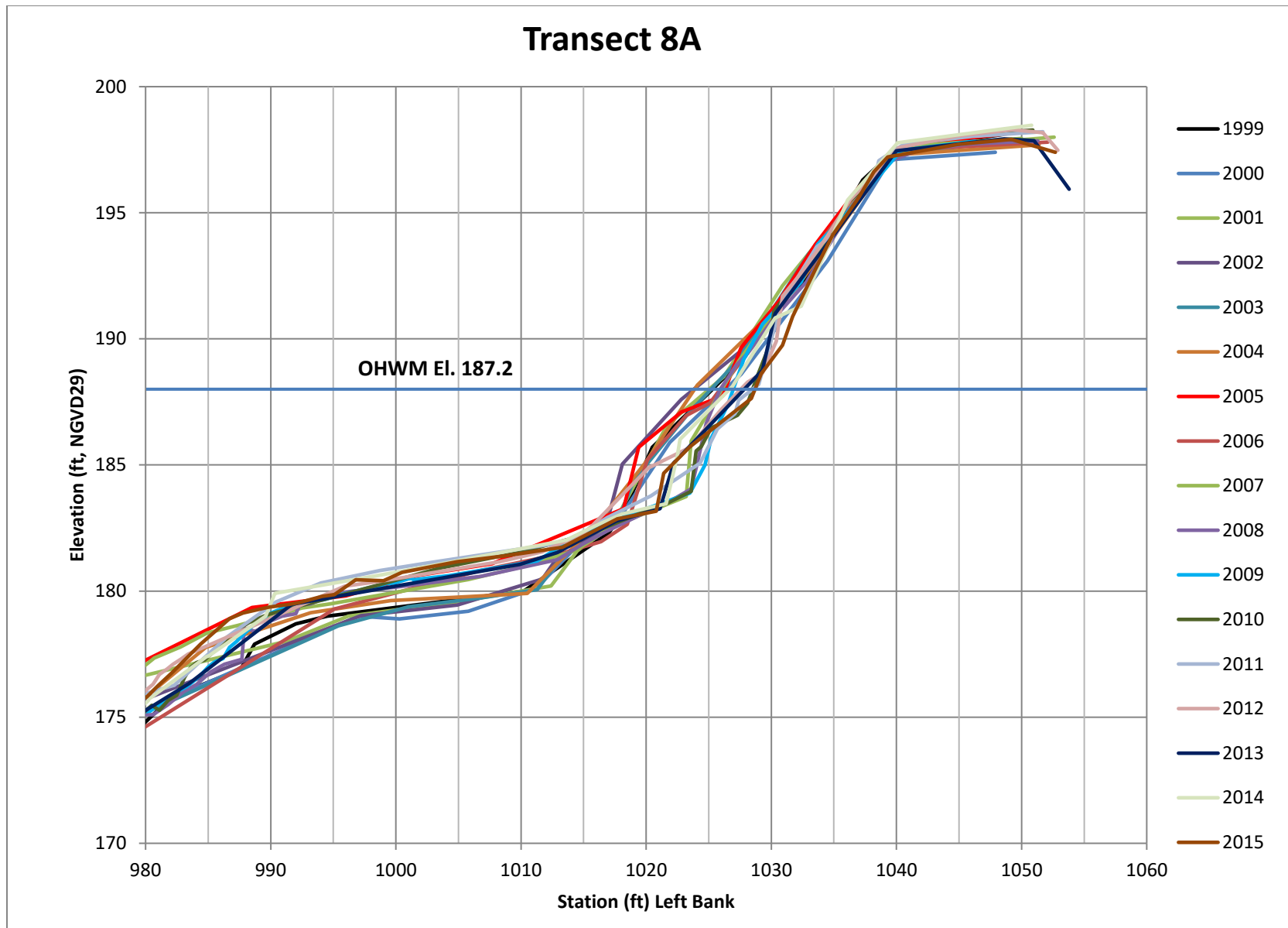


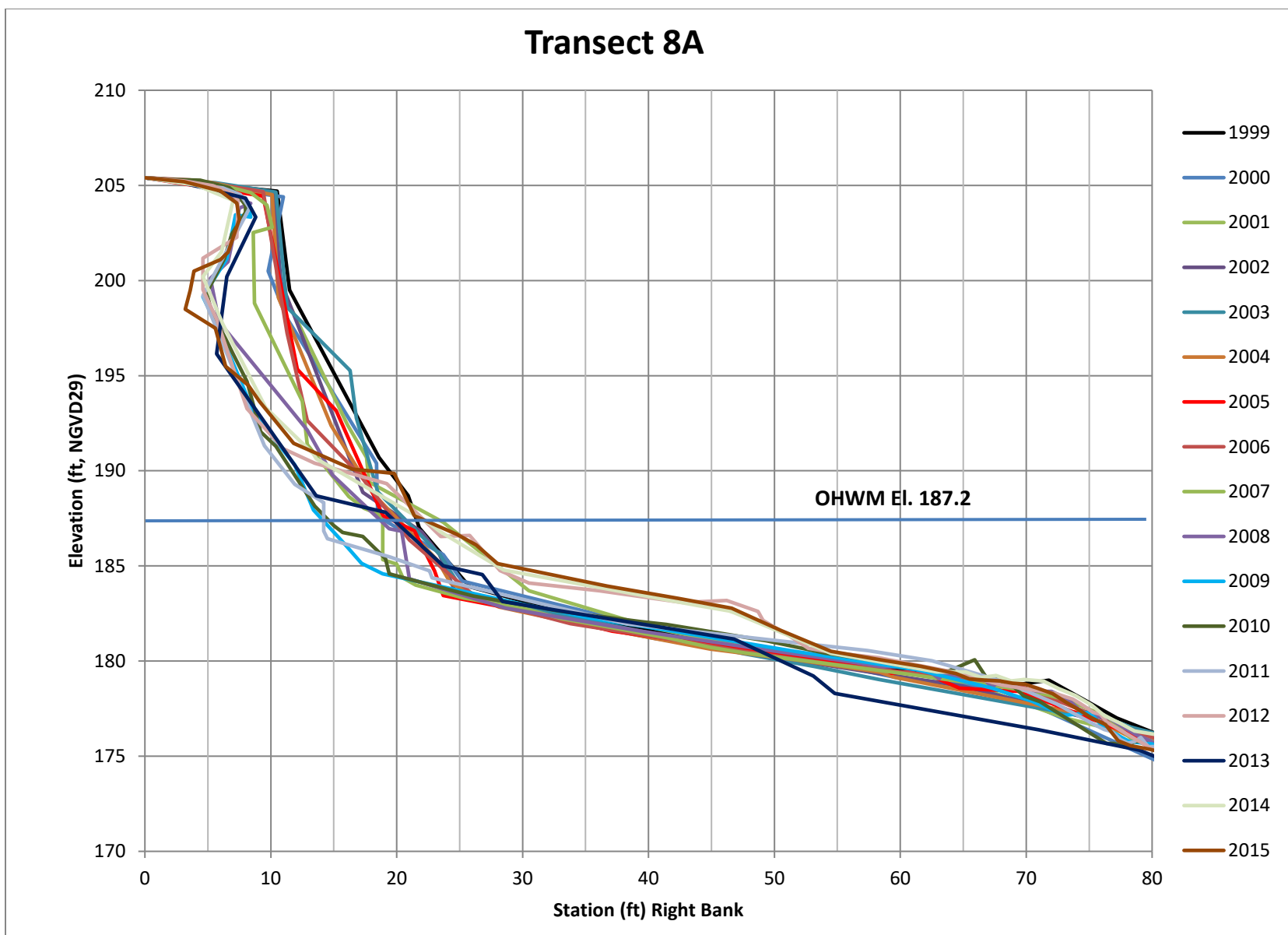


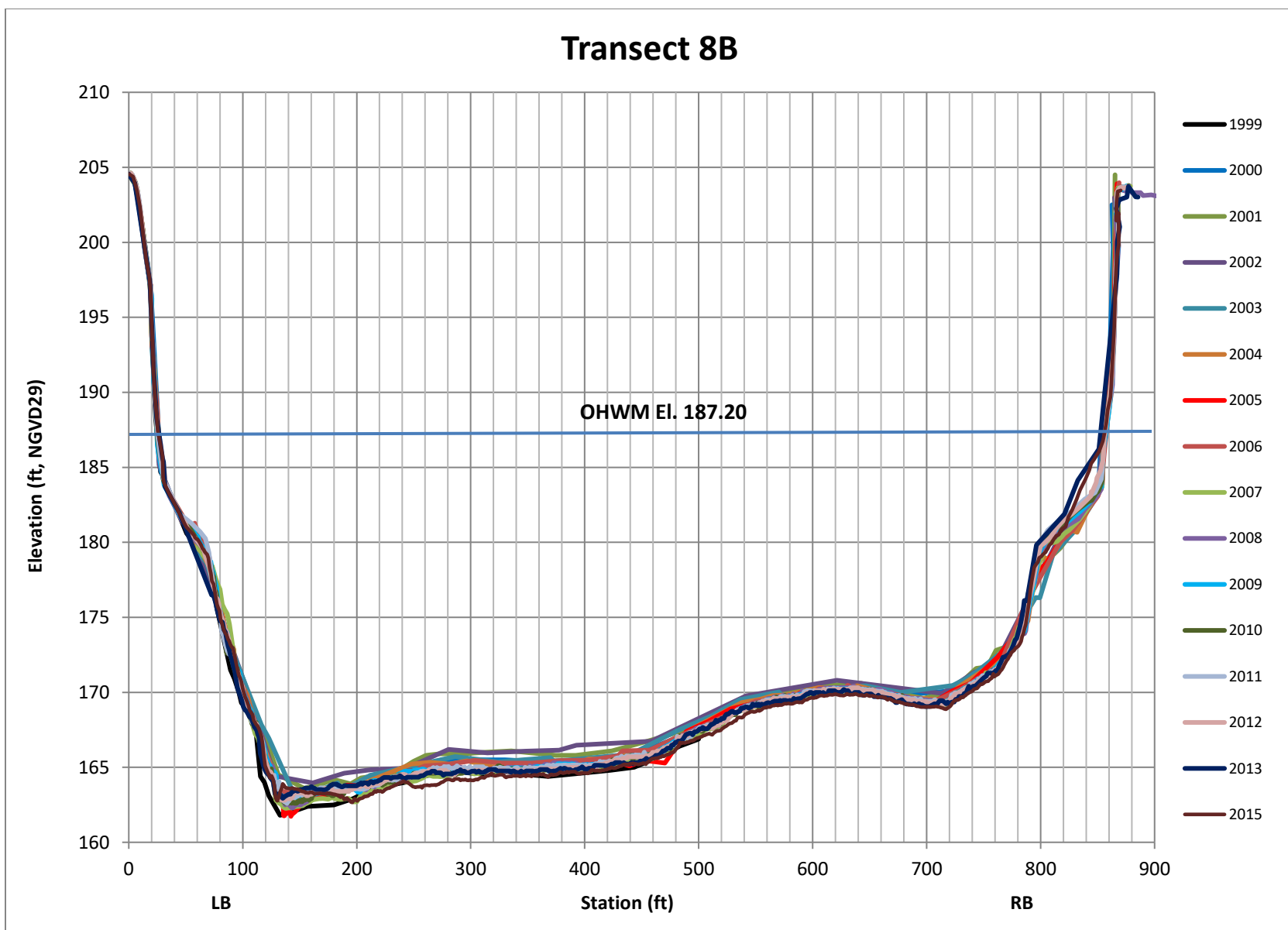




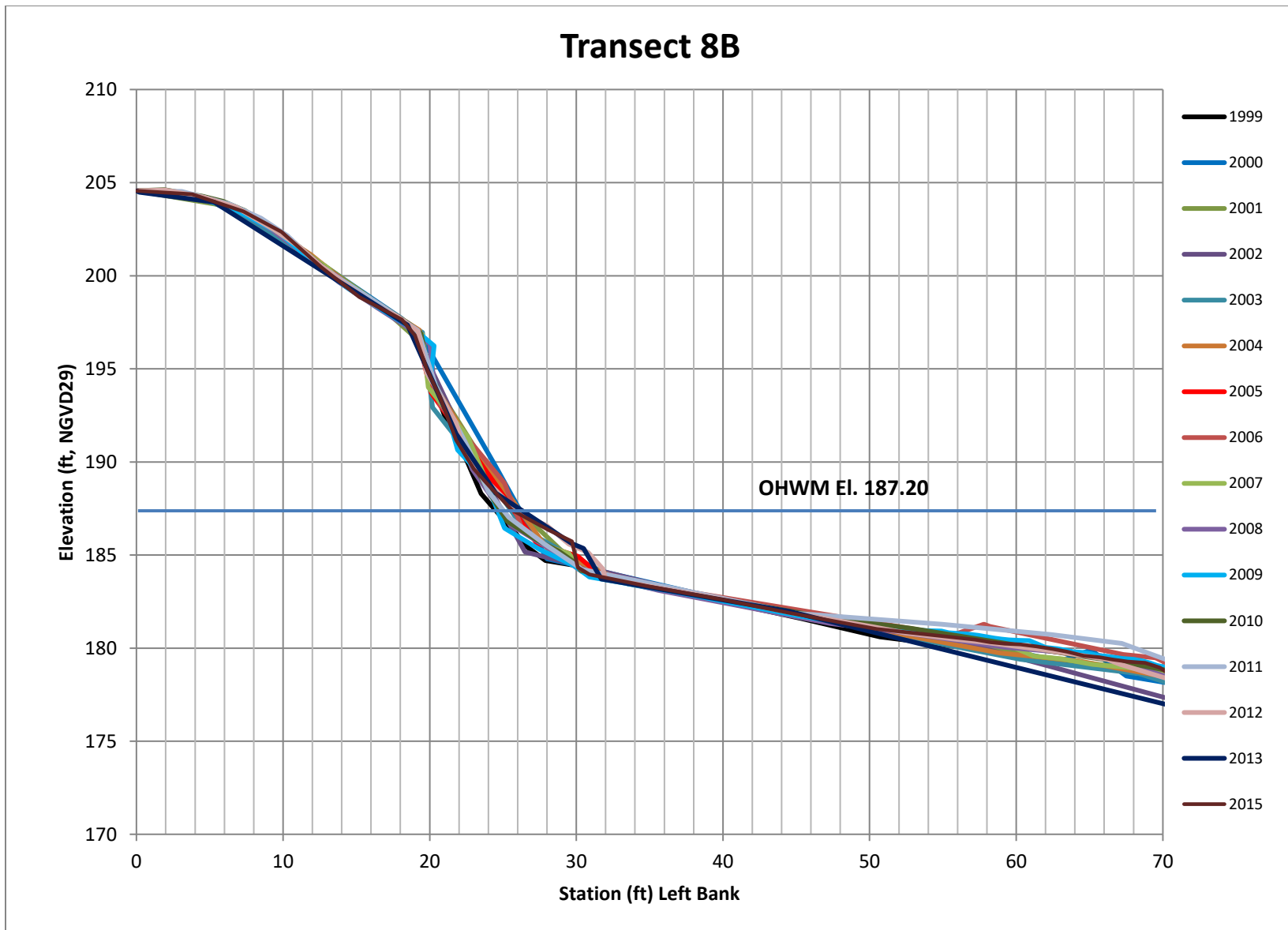


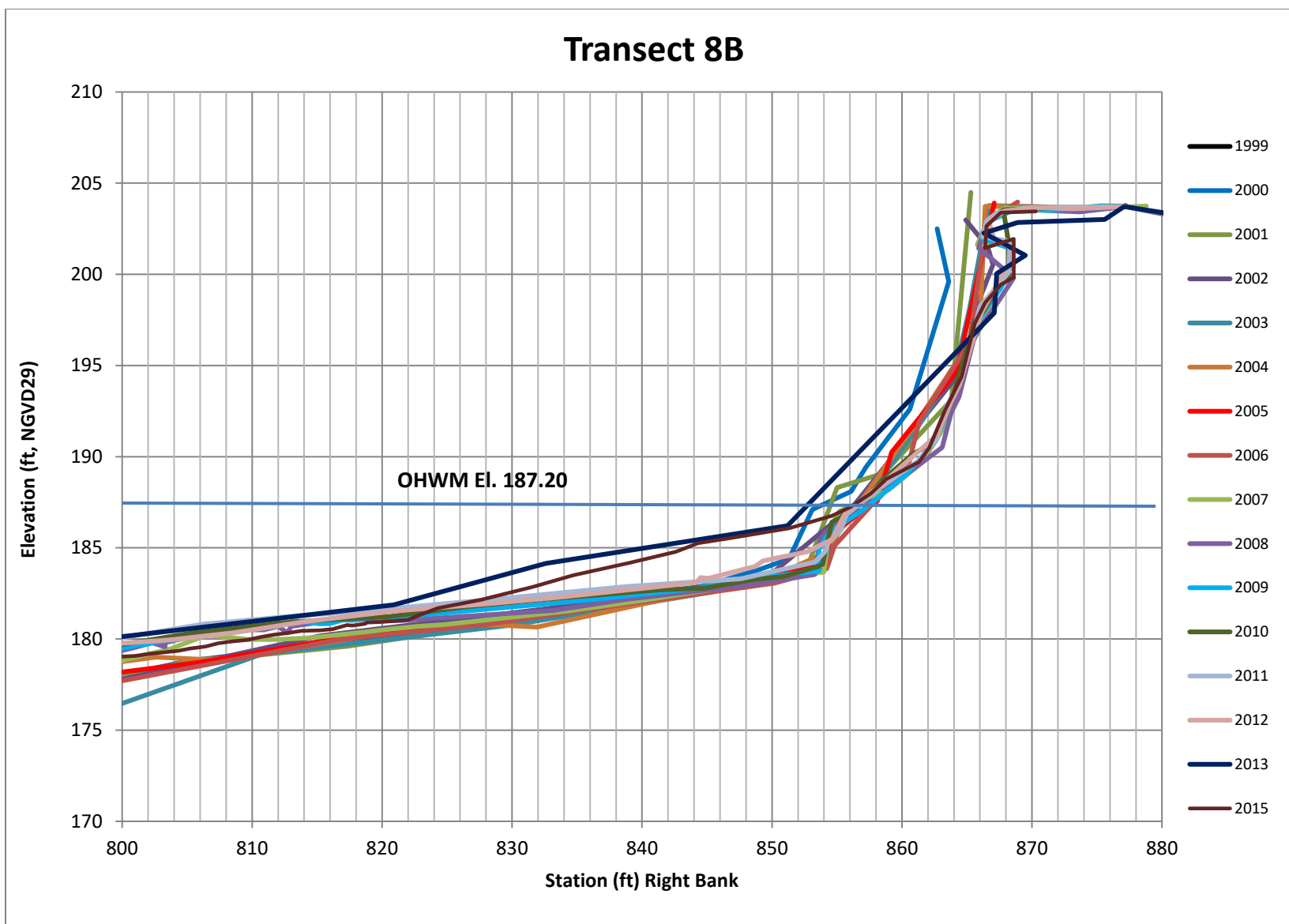


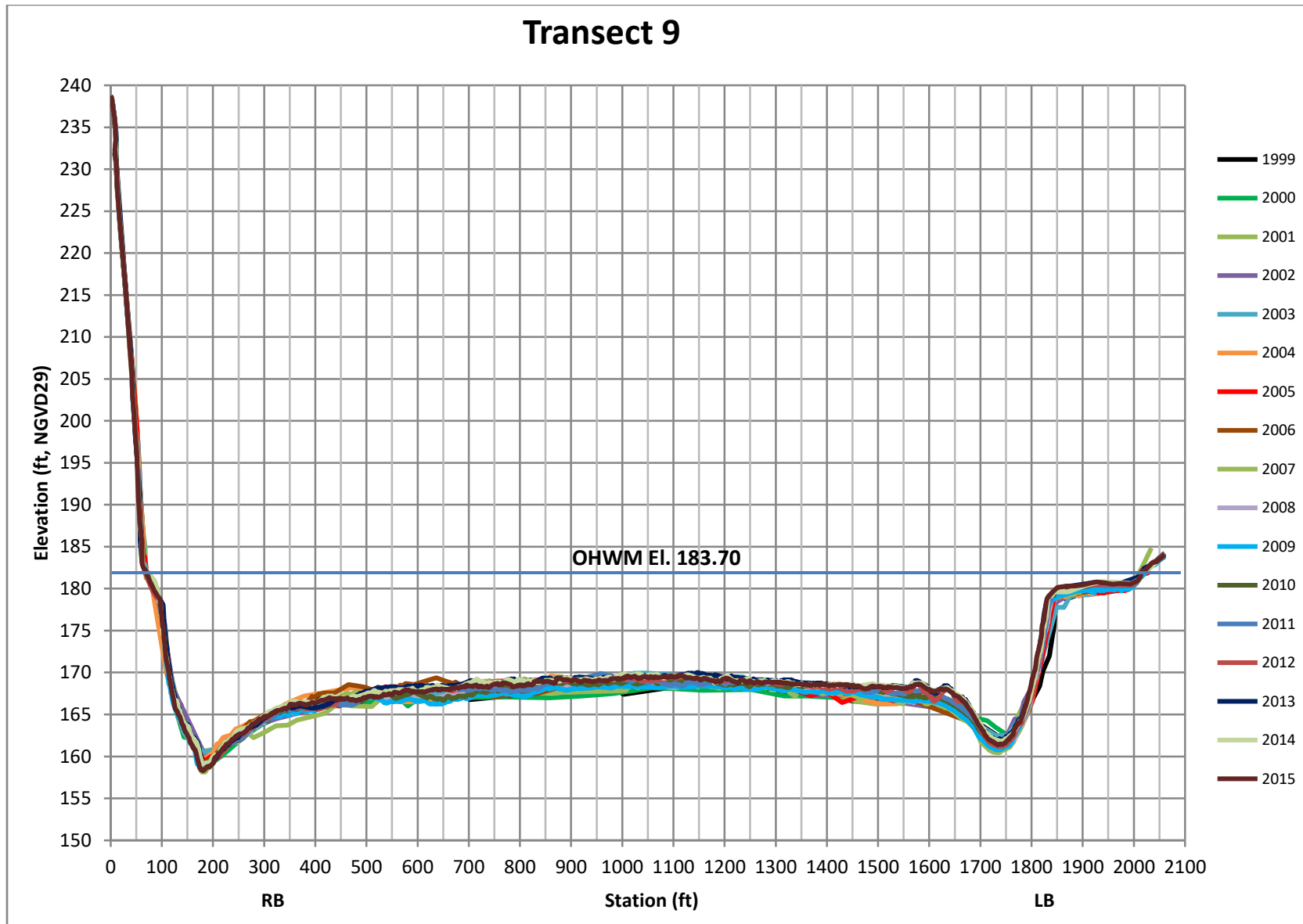


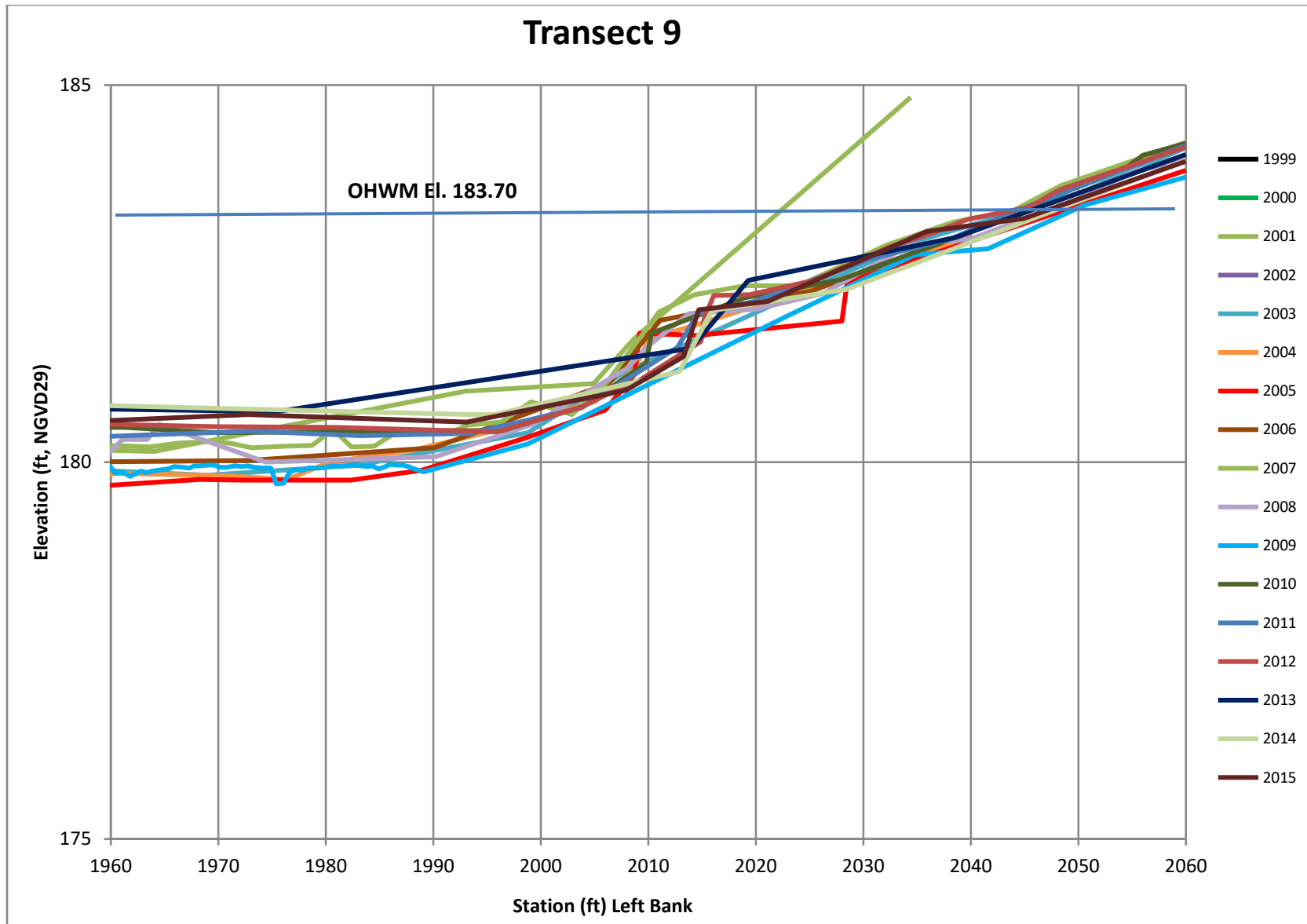


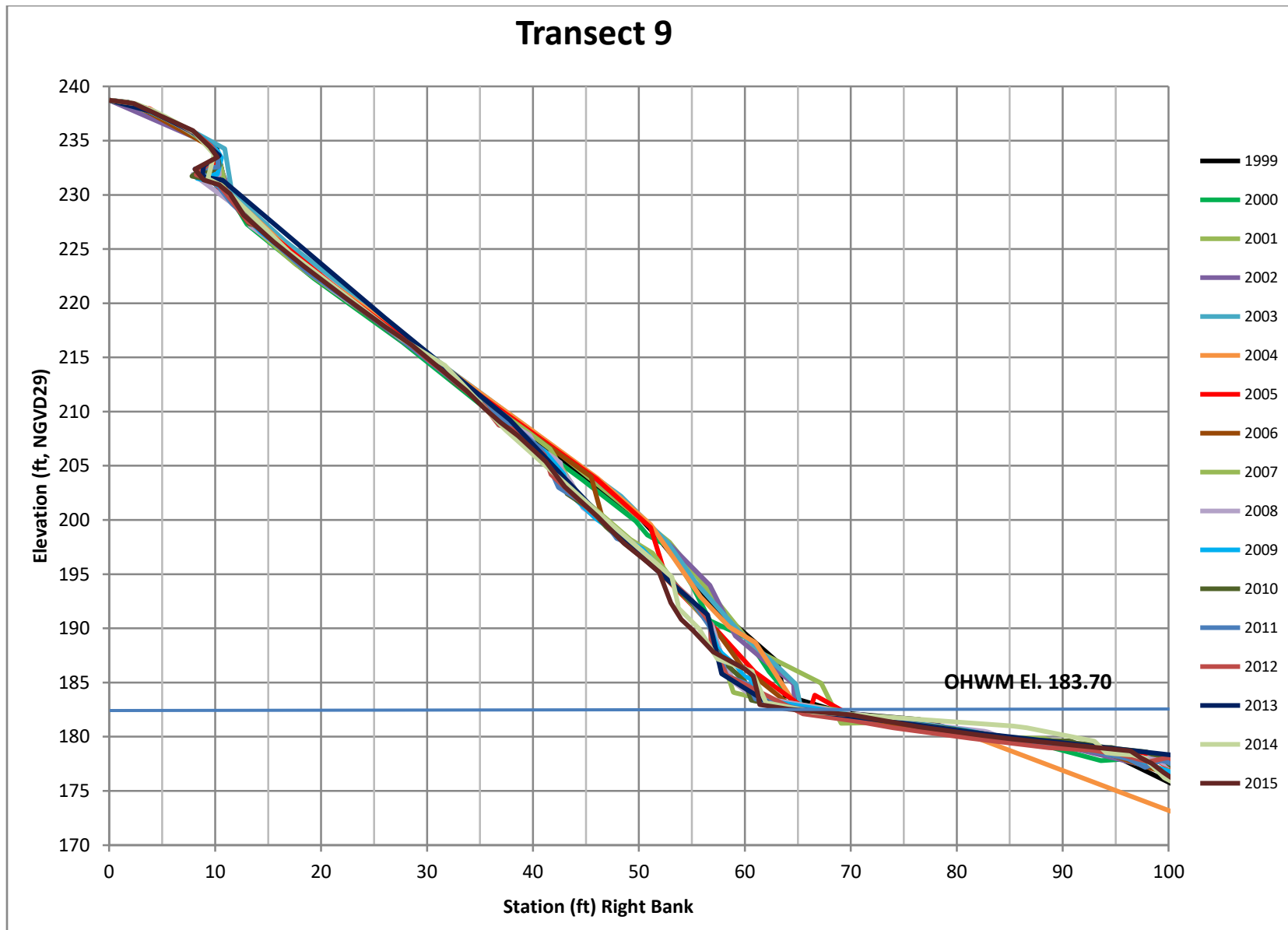


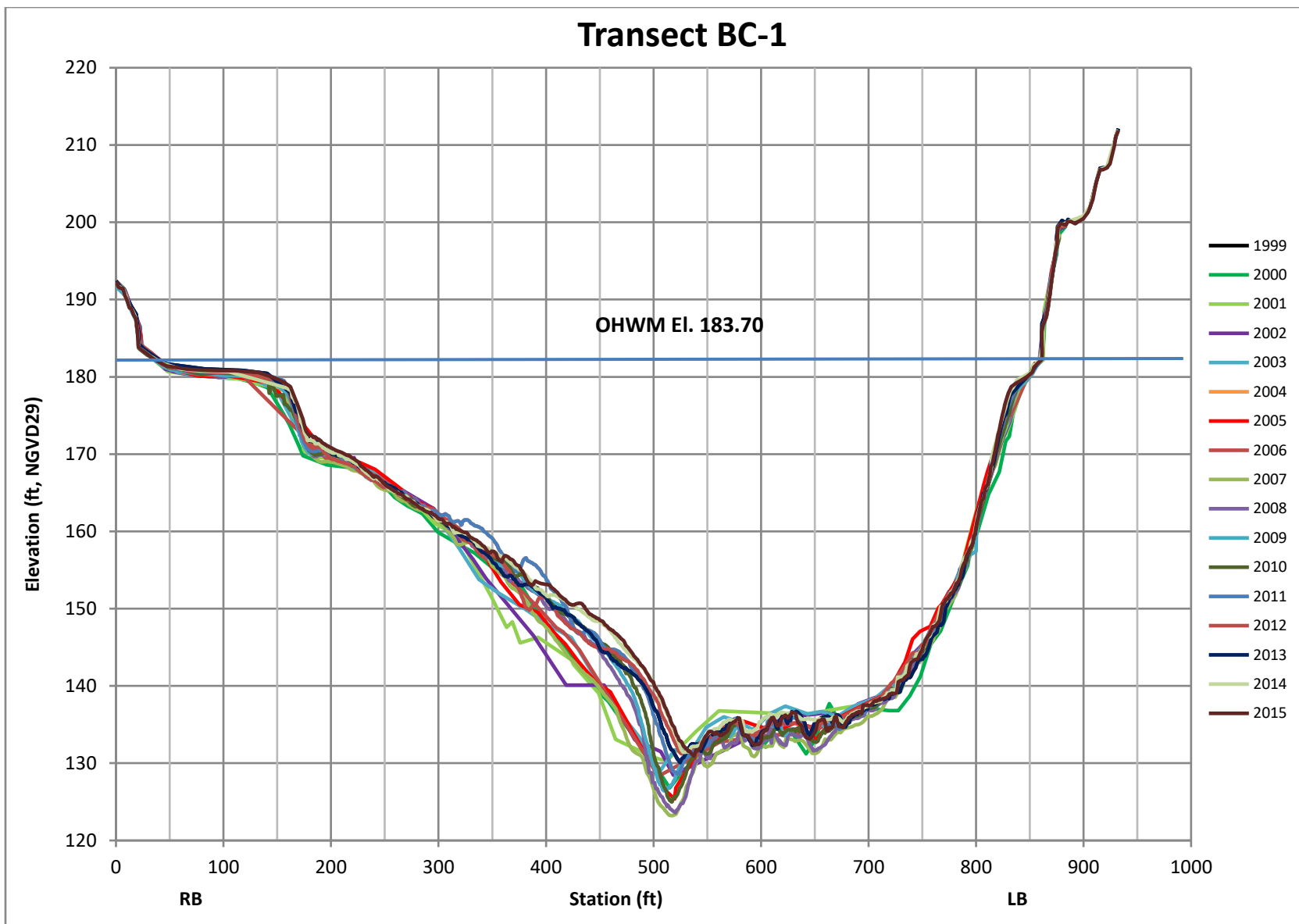


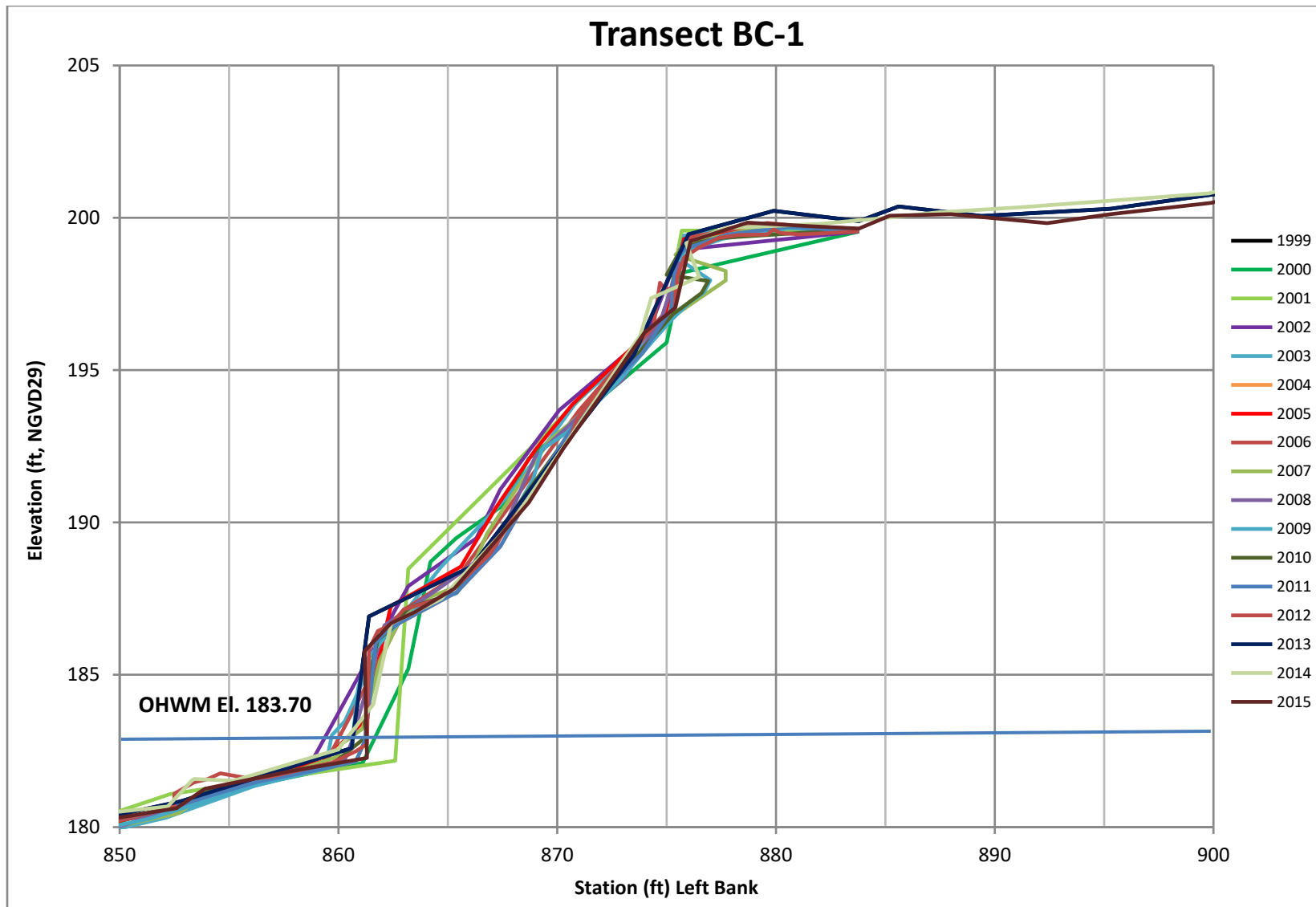


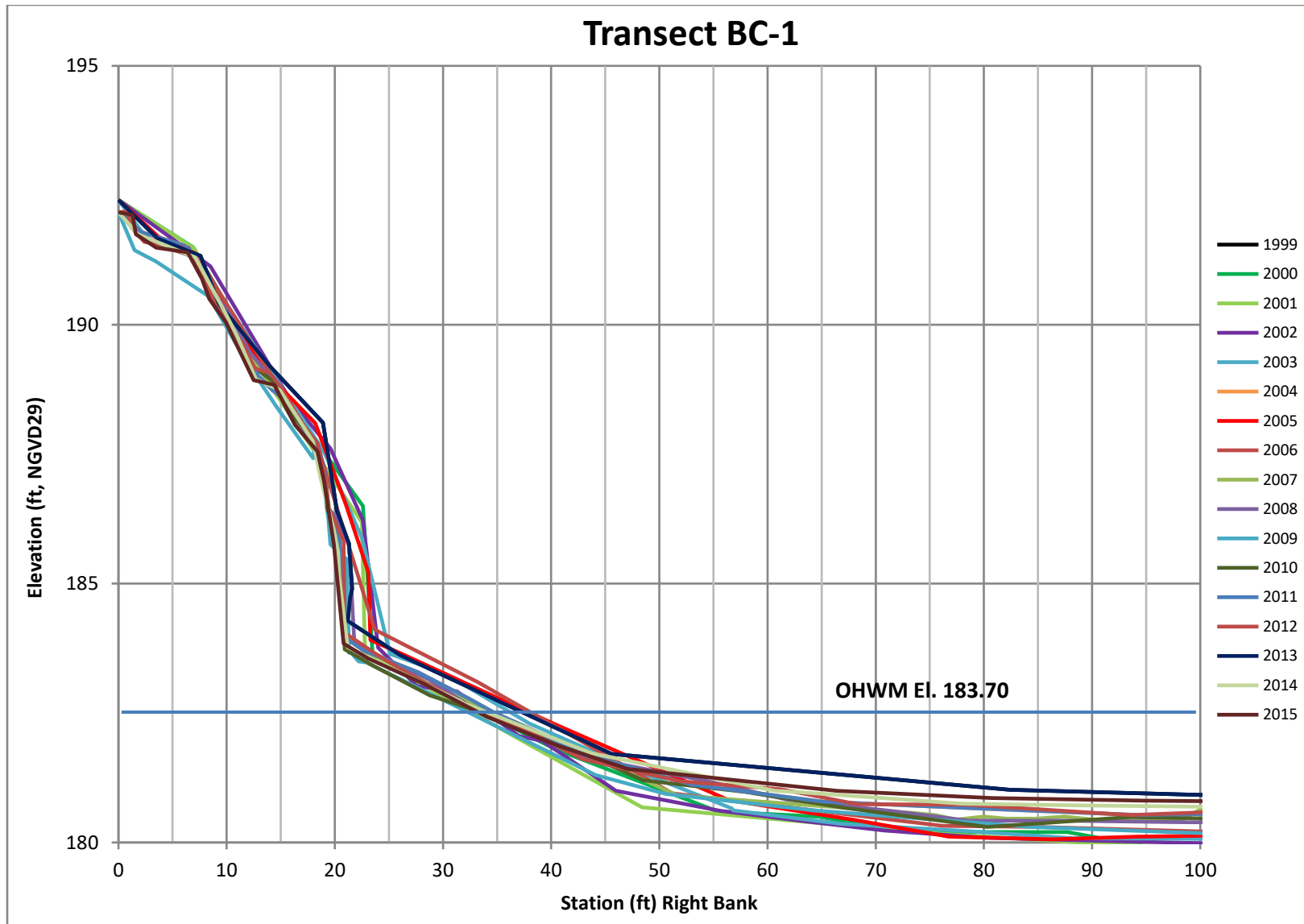








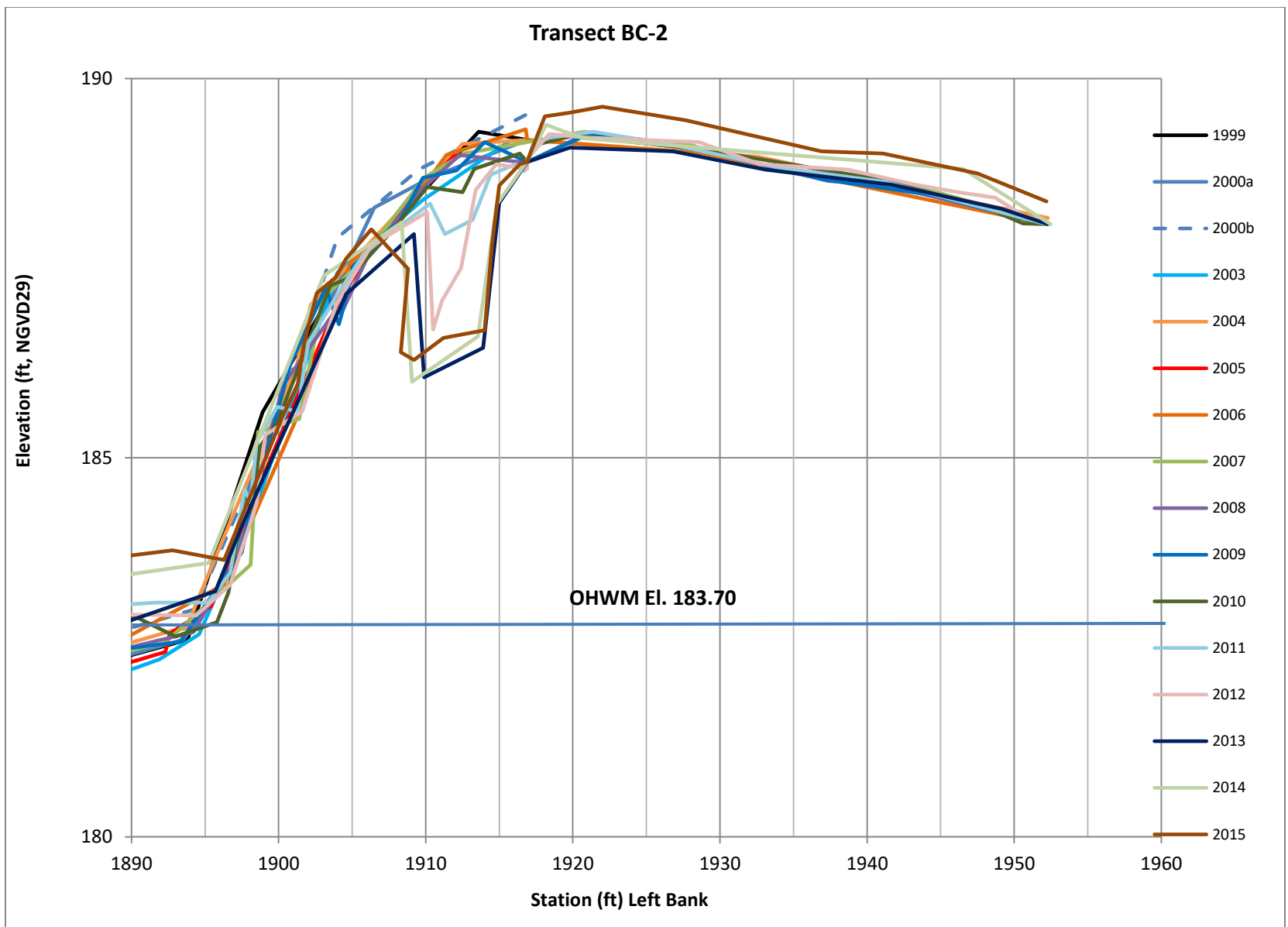


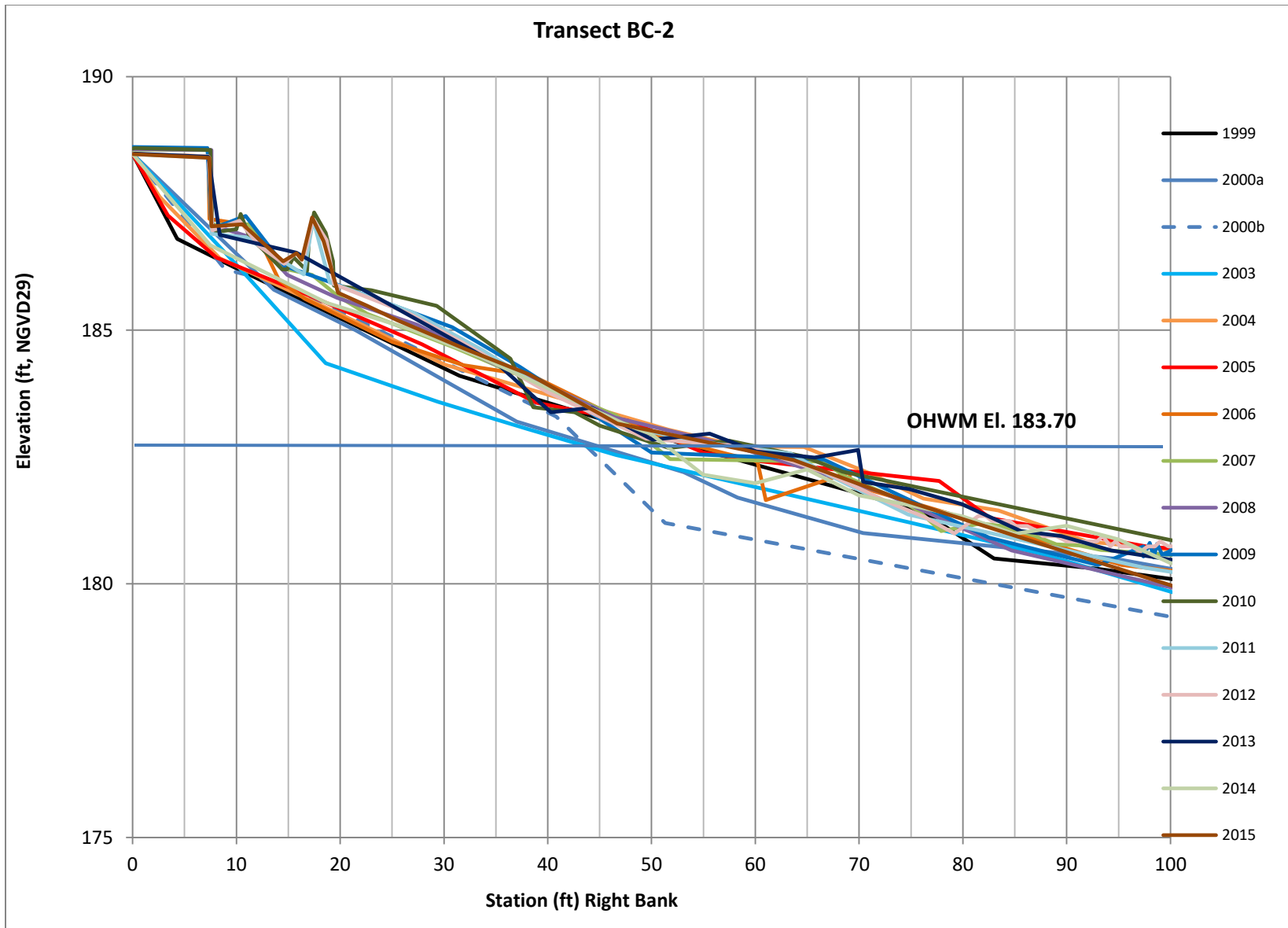




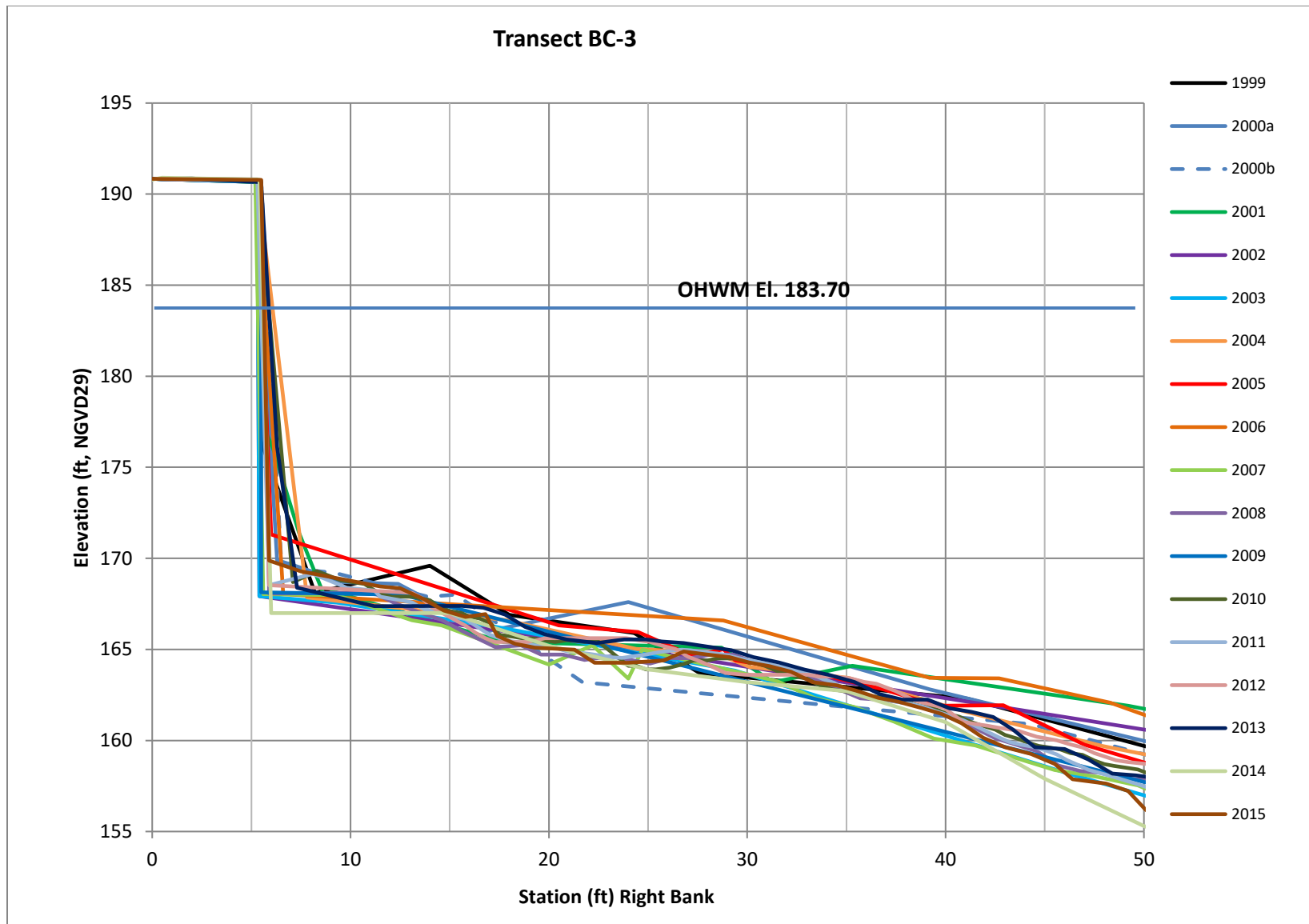


STUDY 3.1.2 NORTHFIELD MOUNTAIN / TURNERS FALLS OPERATIONS IMPACTS ON EXISTING EROSION AND POTENTIAL BANK INSTABILITY

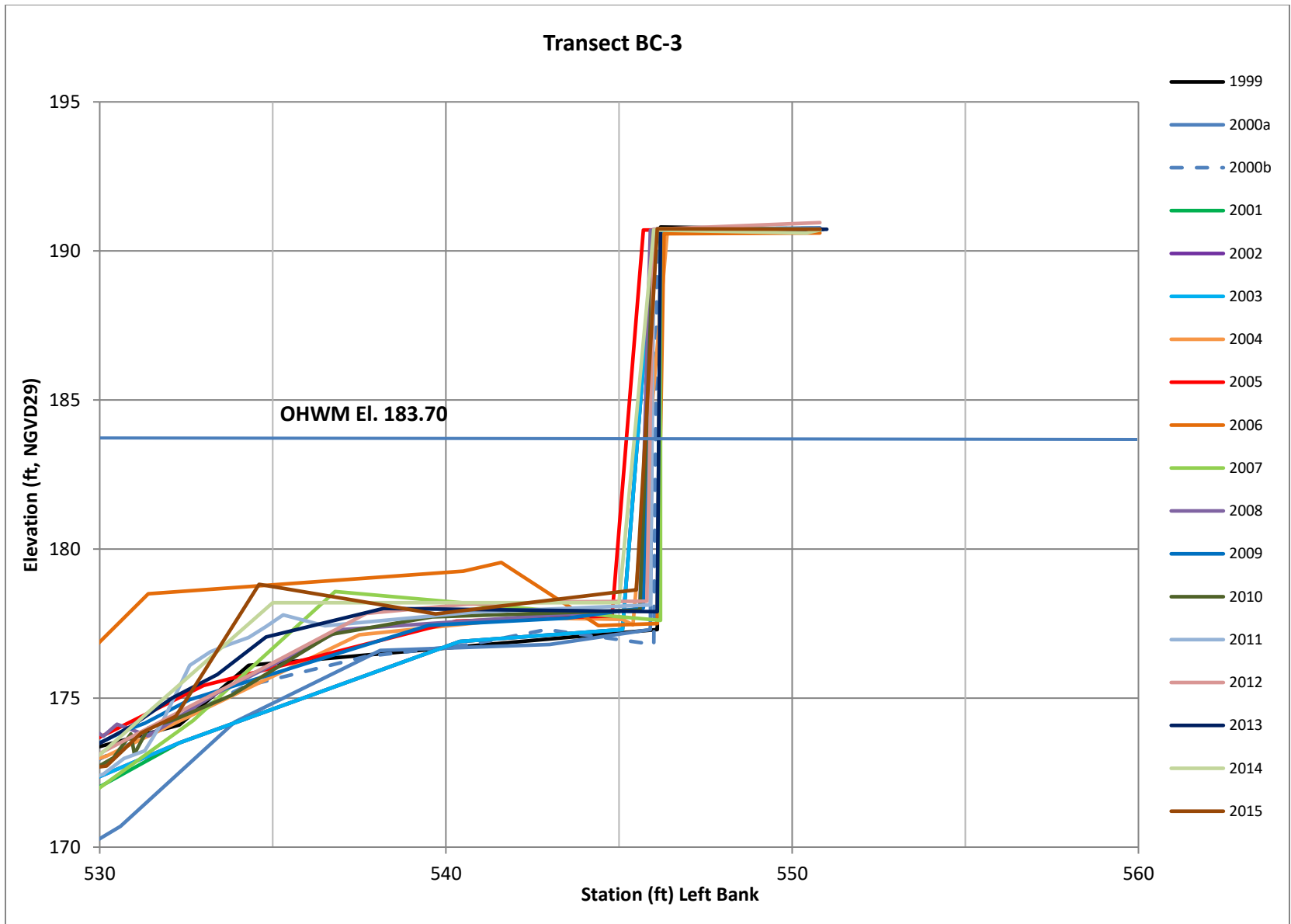




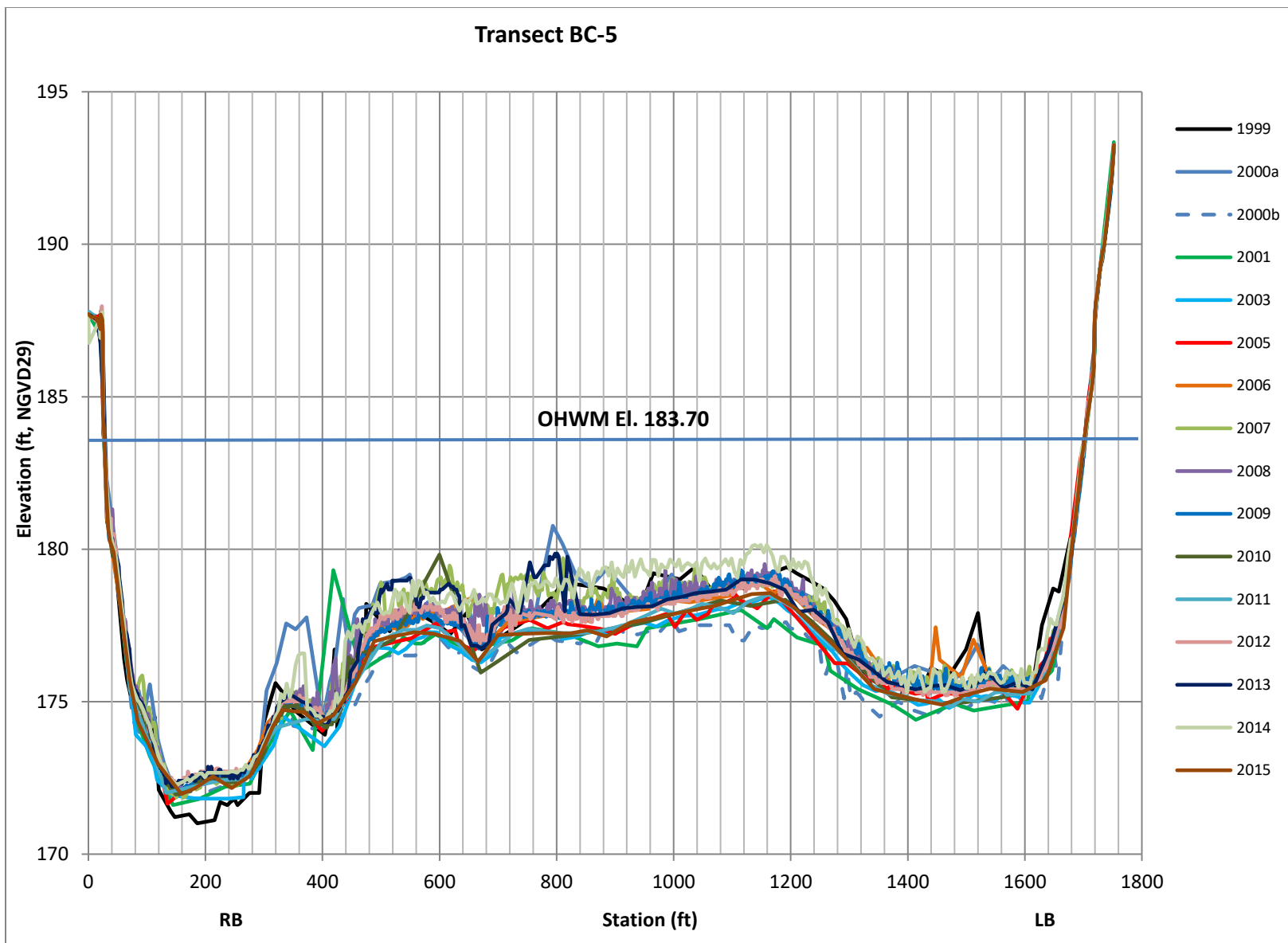


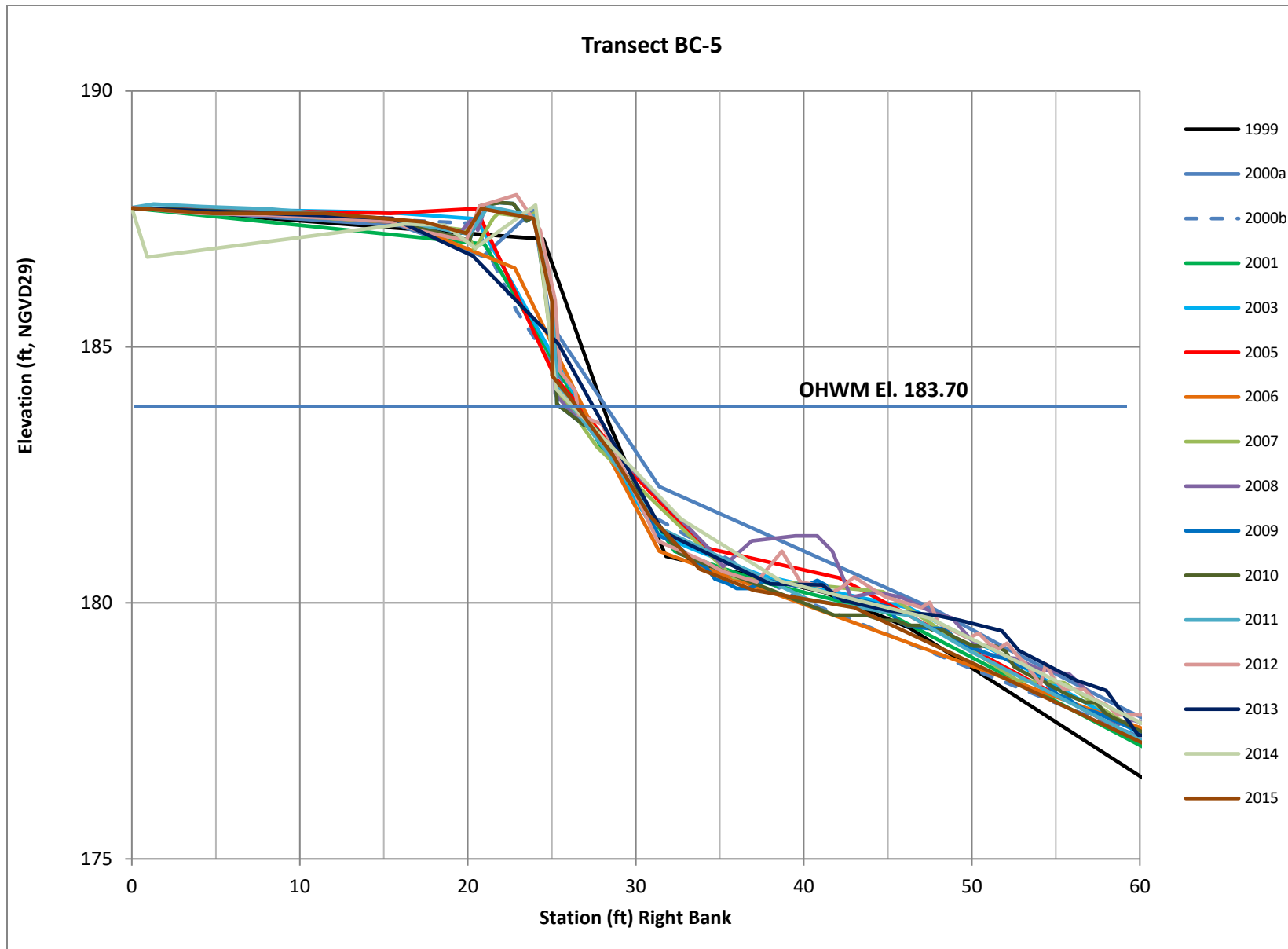


STUDY 3.1.2 NORTHFIELD MOUNTAIN / TURNERS FALLS OPERATIONS IMPACTS ON EXISTING EROSION AND POTENTIAL BANK INSTABILITY

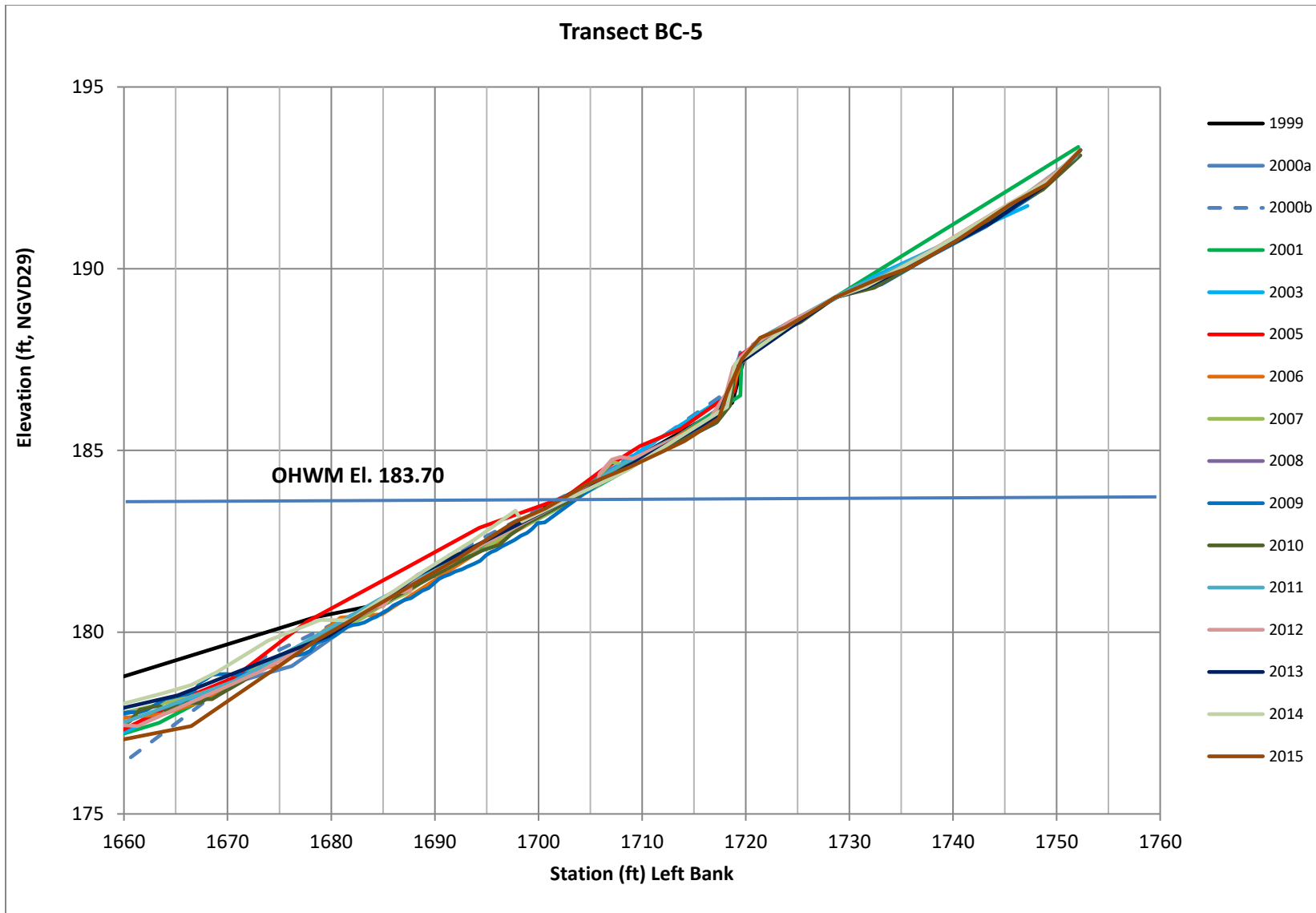


STUDY 3.1.2 NORTHFIELD MOUNTAIN / TURNERS FALLS OPERATIONS IMPACTS ON EXISTING EROSION AND POTENTIAL BANK INSTABILITY









# **APPENDIX F – BSTEM TECHNICAL BACKGROUND**

## Hydraulic Forces Applied to the Bank

The average boundary shear stress ( $\tau_o$ ) acting on each node of the bank material is calculated using:

$$\tau_o = \gamma_w R S \quad (1)$$

where  $\tau_o$  = average boundary shear stress (Pa),  $\gamma_w$  = unit weight of water (9.81 kN/m<sup>3</sup>),  $R$  = local hydraulic radius (m) and  $S$  = channel slope (m/m).

The average boundary shear stress exerted by the flow on each node of the bank profile is determined by dividing the flow area at a cross-section into segments. A line is generated that separates the bed- and bank-affected segments (starting at the base of the bank and extending to the water surface) at an angle equal to the average of the bank- and bank-toe angles (Figure F-1). The hydraulic radius ( $R$ ) of the flow on each segment is the area of the segment ( $A$ ) divided by the wetted perimeter of the segment ( $P_n$ ). Thus the shear stress varies along the bank surface according to equation 1 as parameters comprising the segmented areas change.

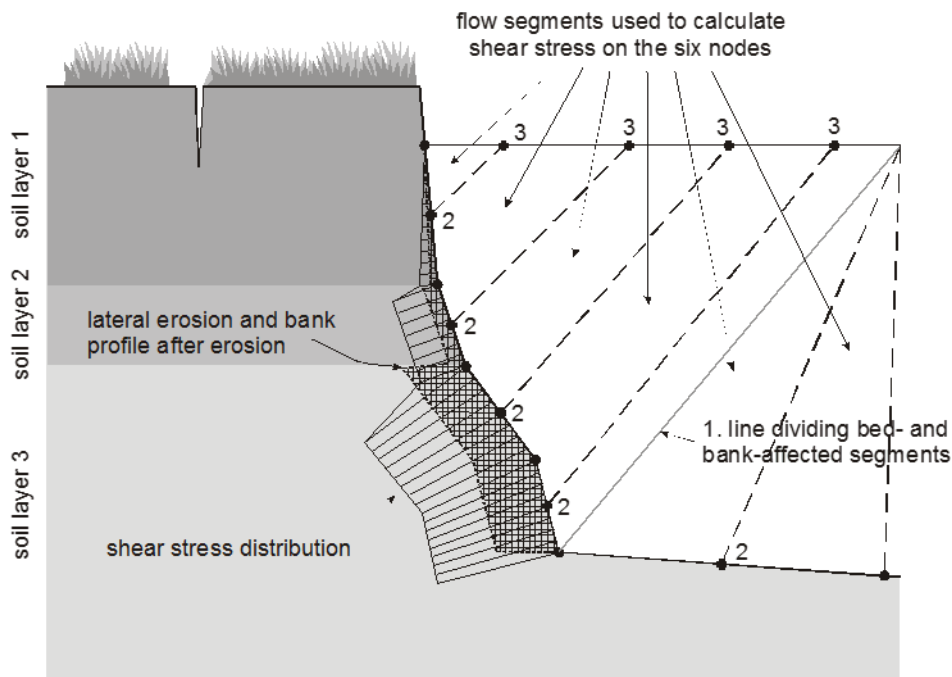


Figure F-1 Segmentation of local flow areas and hydraulic radii.

The stress actually operating on the boundary (grains of bank material) is among other things, a function of flow resistance, which is a result of viscous and pressure drag over its wetted perimeter. For a vegetated channel, this drag may be conceptually divided into three components: 1) the sum of viscous drag on the ground surface and pressure drag on particles or aggregates small enough to be individually moved by the flow (grain roughness); 2) pressure drag associated with large non-vegetal boundary roughness (form roughness); and 3) drag on vegetal elements (vegetal roughness) (Temple *et al.*, 1987). As energy lost to the flow represents work done by a force acting on the moving water, the total boundary shear stress may also be divided into three components:

$$\tau_o = \tau_{og} + \tau_{of} + \tau_{ov} \quad (2)$$

where the subscripts  $g, f$  and  $v$  signify the grain, form and vegetal components of the boundary shear stress, respectively.

If it is assumed that these components may be expressed in terms of a Manning's coefficient for each, and Manning's equation is assumed to apply for each component, equation 8 can be rewritten as (Temple, 1980):

$$n^2 = n_g^2 + n_f^2 + n_v^2 \quad (3)$$

where  $n$  = Manning's roughness coefficient ( $s\ m^{-1/3}$ ). Grain roughness is estimated for each node on the bank profile using the equation of Strickler (Chow, 1959):

$$n_g = 0.045 (D_{50})^{1/6} \quad (4)$$

Combining equations 8 and 9, the effective boundary shear stress, the component of the boundary shear stress acting on the boundary in the absence of form and vegetal roughness, may be computed as:

$$\tau_g = \tau_o (n_g^2 / n^2) \quad (5)$$

An average erosion rate (in m/s) is computed for each node by utilizing an excess-shear stress approach (Partheniades, 1965). This rate is then integrated with respect to time to yield an average erosion distance in centimeters. Erosion is simulated to occur normal to the local bank angle, and not horizontally:

$$E = k \Delta t (\tau_o - \tau_c) \quad (6)$$

where  $E$  = erosion distance (cm),  $k$  = erodibility coefficient ( $cm^3/N\cdot s$ ),  $\Delta t$  = time step (s),  $\tau_o$  = average boundary shear stress (Pa), and  $\tau_c$  = critical shear stress (Pa).

The rate of erosion of bank-face, bank-toe and bed materials can then be calculated using equations 5 and 6 (Hanson, 1990). During the dynamic simulations described herein, the horizontal erosion distance during a timestep is computed by integrating the erosion rate within the timestep by the timestep size:

$$E = \varepsilon \Delta t \quad (7)$$

where  $E$  = erosion distance (m), and  $\Delta t$  = timestep (s).

### Resistance to Hydraulic Forces

Resistance of bank-toe and bank-surface materials to erosion by hydraulic shear is handled differently for cohesive and non-cohesive materials. For cohesive materials the relation developed by Hanson and Simon (2001) using a submerged jet-test device (Hanson, 1990; 1991) is used:

$$k = 0.2 \tau_c^{-0.5} \quad (8)$$

The Shields (1936) criterion is used for resistance of non-cohesive materials as a function of roughness and particle size (weight), and is expressed in terms of a dimensionless critical shear stress:

$$\tau^*_c = \tau_o / [(\rho_s - \rho_w) g D] \quad (9)$$

where  $\tau^*_c$  = critical dimensionless shear stress,  $\rho_s$  = sediment density (kg/m<sup>3</sup>),  $\rho_w$  = water density (kg/m<sup>3</sup>),  $g$  = gravitational acceleration (m/s<sup>2</sup>), and  $D$  = characteristic particle diameter (m).

### Resistance to Geotechnical Forces

Soil shear strength varies with the moisture content of the bank and the elevation of the saturated zone in the bank mass. In the part of the streambank above the “normal” level of the groundwater table, bank materials are unsaturated, pores are filled with both water and air, and pore-water pressure is negative. The difference ( $\mu_a - \mu_w$ ) between the air pressure,  $\mu_a$ , and the water pressure in the pores,  $\mu_w$ , represents matric suction. The increase in shear strength due to an increase in matric suction ( $\mu_a - \mu_w$ ) is described by the angle  $\phi^b$ .  $\phi^b$  varies for all soils and with moisture content for a given soil (Fredlund and Rahardjo, 1993), but generally takes a value between 10° and 20°, with a maximum of the effective soil friction angle,  $\phi'$ , under saturated conditions (Fredlund and Rahardjo, 1993). The effect of matric suction on shear strength is reflected in the apparent cohesion ( $c_a$ ) term, which incorporates both electro-chemical bonding within the soil matrix (described by the effective cohesion,  $c'$ ) and cohesion due to surface tension on the air-water interface of the unsaturated soil:

$$c_a = c' + (\mu_a - \mu_w) \tan \phi^b \quad (10)$$

where  $c_a$  = apparent cohesion (kPa),  $c'$  = effective cohesion (kPa),  $\mu_a$  = pore-air pressure (kPa),  $\mu_w$  = pore-water pressure, ( $\mu_a - \mu_w$ ) = matric suction (kPa) and  $\phi^b$  is the angle describing the increase in shear strength due to an increase in matric suction (degrees).

As can be seen from equation 1, negative pore-water pressures (positive matric suction) in the unsaturated zone provide for cohesion greater than the effective cohesion, and thus, greater shearing resistance. This is often manifest in steeper bank slopes than would be indicated by  $\phi'$ . Conversely, the wetter the bank and the higher the water table, the weaker the bank mass becomes and the more prone it is to failure. Accounting for the effects of friction, the shear strength of a soil,  $\tau_s$ , may thus be described by the Mohr-Coulomb shear strength criterion for unsaturated soils (Fredlund *et al.*, 1978):

$$\tau_s = \frac{1}{F_s} [c' + (\mu_a - \mu_w) \tan \phi^b + (\sigma - \mu_a) \tan \phi'] \quad (11)$$

where  $F_s$  = Factor of Safety, the ratio between the resisting and driving forces acting on a potential failure block,  $\sigma$  = normal stress on the shear plane (kPa) and  $\phi'$  = effective angle of internal friction (degrees).

While it is assumed that the pore-air pressure is atmospheric (i.e.  $\mu_a = 0$ ), positive and negative pore-water pressures are calculated for the mid-point of each layer based on hydrostatic pressure above and below the water table so that:

$$\mu_w = \gamma_w h \quad (12)$$

where  $\mu_w$  = pore-water pressure (kPa),  $\gamma_w$  = unit weight of water (9.807 kN m<sup>-3</sup>) and  $h$  = head of water above the mid-point of the layer (m).

The geotechnical driving forces are controlled by bank height and slope, the unit weight of the soil and the mass of water within it, and the surcharge imposed by any objects on the bank top. The methods used to calculate the  $F_s$  are horizontal layers (Simon and Curini, 1998; Simon *et al.*, 2000), vertical slices for failures with a tension crack (Morgenstern and Price, 1965) and cantilever failures (Thorne and Tovey, 1981). For planar failures without a tension crack, the Factor of Safety ( $F_s$ ) for both the saturated and unsaturated parts of the failure plane is given by the ratio of the resisting and driving forces (Simon and Curini, 1998; Simon *et al.*, 1999; 2000):

$$F_s = \frac{\sum_{i=1}^I (c'_i L_i + S_i \tan \phi_i^b + [W_i \cos \beta - U_i + P_i \cos(\alpha - \beta)] \tan \phi_i')}{\sum_{i=1}^I (W_i \sin \beta - P_i \sin[\alpha - \beta])} \quad (13)$$

where  $c'_i$  = effective cohesion of  $i$ th layer (kPa),  $L_i$  = length of the failure plane incorporated within the  $i$ th layer (m),  $S_i$  = force produced by matric suction on the unsaturated part of the failure surface (kN/m),  $\phi^b$  = angle representing the rate of increase in shear strength with increasing matric suction ( $^\circ$ ),  $W_i$  = weight of the  $i$ th layer (kN),  $U_i$  = the hydrostatic-uplift force on the saturated portion of the failure surface (kN/m),  $P_i$  = the hydrostatic-confining force due to external water level (kN/m),  $\beta$  = failure-plane angle (degrees from horizontal),  $\alpha$  = bank angle (degrees from horizontal),  $\phi'$  = angle of internal friction ( $^\circ$ ), and  $I$  = the number of layers.

The hydrostatic confining force,  $P_i$ , is calculated from the area of the confining pressure ( $\gamma_w h$ ) by:

$$P_i = \frac{\gamma_w h^2}{2} \quad (14)$$

where  $h$  = head of water in the channel (m). The loss of the hydrostatic-confining force is the primary reason bank failures often occur after the peak flow and on the recessional limb of hydrographs.

The cantilever shear failure algorithm is a further development of the method employed by Langendoen, (2000). Put simply, the  $F_s$  is the ratio of the shear strength of the soil to the weight of the cantilever. The inclusion of  $\alpha$ -terms in equation 24 ensures that if the bank is partially or totally submerged the weights of the layers affected by water are correctly reduced irrespective of the geometry of the basal surface of the overhang. The cantilever shear-failure algorithm results from inserting  $\beta = 90^\circ$  into equation 13 and simplifying.  $F_s$  is given by:

$$F_s = \frac{\sum_{i=1}^I [(c'_i + c_r) L_i + (\mu_a - \mu_w)_i L_i \tan \phi_i^b + [P_i \sin \alpha - \mu_{ai} L_i] \tan \phi_i']}{\sum_{i=1}^I (W_i + P_i \cos \alpha)} \quad (15)$$

BSTEM-Dynamic can utilize the different failure algorithms depending on the geometry and conditions of the bank. Determining whether a failure is planar or cantilever is based on whether there is undercutting and then comparing the factor of safety values. The failure mode is automatically determined by the smaller of the two values. The model is easily adapted to incorporate the effects of geotextiles or other bank stabilization measures that affect soil strength. During a given time step, the model assumes hydrostatic conditions below the water table. Matric suction above the water table (negative pore-water pressure) is calculated by linear extrapolation.

### Modeling Movement of the Groundwater Table

It is apparent from the above discussion that the elevation of the groundwater table is an important parameter controlling soil shear strength. For the purposes of this study, a simplified one-dimensional (1-D) groundwater model, based on the 1-D Richards Equation, was developed to simulate the motion of the groundwater table. This model assumes that the dominant pressure gradient within a streambank is the difference between the groundwater table elevation and the in-channel water surface elevation (i.e., it neglects the influence of infiltrating precipitation) (e.g. Langendoen, 2010). Assuming that water infiltrates either into or out of the bank along a horizontal plane of unit length and computing distance-weighted mean soil properties between these two elevations, the simplified equation can be written as:

$$\frac{\partial h}{\partial t} - K_r K_{sat} |h - z|^2 = 0 \quad (16)$$

where  $h$  = groundwater elevation (m),  $z$  is the water surface elevation (m),  $t$  = time (s), and  $K_r K_{sat}$  = relative permeability  $\times$  saturated hydraulic conductivity.  $K_r$  is evaluated as  $K_r = \Theta^{1/2} \left[ 1 - (1 - \Theta^{1/n})^n \right]^2$ , where  $\Theta$  = soil saturation and, following van Genuchten (1980),  $\Theta$  is evaluated as:

$$\Theta = \Theta_r + \frac{\Theta_s - \Theta_r}{\left[ 1 + \left( \frac{[z - h]}{\alpha} \right)^{1/1-n} \right]^n} \quad (17)$$

where the subscripts  $r$  and  $s$  denote the residual moisture content and saturated moisture content (= porosity), and  $\alpha$  and  $n$  are curve-fitting parameters defined by van Genuchten (1980). Note that if  $h \geq z$ ,  $K_r = 1$ . The user provides the initial groundwater elevation at the start of the simulation. This is usually set to the starting surface-water elevation. Default values by material type are provided for selection by the User on the *Bank Material* page of the model. Values of saturated hydraulic conductivity can also be used if available.

### Modeling Root-Reinforcement

Waldron (1977) extended the Coulomb equation for root-permeated soils, by assuming that all roots extended vertically across a horizontal shearing zone, and that the roots act like laterally loaded piles, with tension transferred to them as the soil is sheared. In the Waldron (1977) model, the tension developed in the root as the soil is sheared is resolved into a tangential component resisting shear and a normal component increasing the confining pressure on the shear plane.  $\Delta S$  can be represented by:

$$\Delta S = T_r (\sin \theta + \cos \theta \tan \phi) (A_R/A) \quad (18)$$

where  $T_r$  is the average tensile strength of roots per unit area of soil (kPa),  $A_R/A$  is the root area ratio (dimensionless), and  $\theta$  is the angle of shear distortion in the shear zone.

Gray (1974) reported that the angle of internal friction of the soil appeared to be affected little by the presence of roots. Sensitivity analyses carried out by Wu et al. (1979) showed that the value of the first angle term in equation 6 is fairly insensitive to normal variations in  $\theta$  and  $\phi$  (40-90°, and 25-40°, respectively) with values ranging from 1.0 to 1.3. A value of 1.2 was, therefore, selected by Wu et al. (1979) to replace the angle term and the simplified equation becomes:

$$\Delta S = 1.2 T_r (A_R/A) \quad (19)$$

According to the simple perpendicular root model of Wu *et al.* (1979), the magnitude of reinforcement simply depends on the amount and strength of roots present in the soil. However, Pollen *et al.* (2004) and Pollen and Simon (2005), found that these perpendicular root models tend to overestimate root-reinforcement due to the inherent assumption that the full tensile strength of each root is mobilized during soil shearing, and that the roots all break simultaneously. This overestimation was largely corrected by Pollen and Simon (2005) by constructing a fiber-bundle model (RipRoot) to account for progressive breaking during mass failure. Validation of RipRoot versus the perpendicular model of Wu *et al.* (1979) was carried out by comparing results of root-permeated and non-root-permeated direct-shear tests. The direct-shear tests revealed that accuracy was improved by an order of magnitude by using RipRoot estimates (Pollen and Simon, 2005; Mickovski et al., 2009).

A further paper by Pollen (2007) investigated the forces required to pull out roots in a field study, and the RipRoot model was modified to account for both root-failure mechanisms. The addition of pullout forces allowed for estimations of spatial variability in root-reinforcement with changes in soil texture, and temporal changes with changes in soil water. In the RipRoot model currently embedded in BSTEM, a vegetation assemblage can be created by accessing the species database contained in the sub model; the user enters species, approximate vegetation ages, and approximate percent cover of each species at each site to estimate root density. This database includes tests performed across the United States and particularly along the Turner Falls reach of the Connecticut River. Root-reinforcement values are then calculated automatically using RipRoot's progressive breaking algorithm.



# **APPENDIX G – BSTEM BOAT WAVE ALGORITHM TECHNICAL BACKGROUND**

## **Introduction**

Wave action can significantly contribute to bank erosion, increase suspended sediment concentration and turbidity, and induce streambank failure in navigable inland waterways. The most important sources of waves in these streams are wind generated and boat-generated waves. In relatively narrow waterways, short fetch lengths limit the size of the wind-generated waves; therefore, waves generated by moving vessels have a larger contribution to streambank erosion. Frequent passes of high-speed vessels in shallow waterways can create velocities much larger than the mean flow velocity. Measurement in Kenai River in Alaska showed that the energy at the bankline from boat waves alone is up to 59 percent of energy at the bankline from streamflow (Maynard, 2008). Due to the popularity of recreational vessels in recent years, boat induced wave erosion became a major concern (McConchie and Toleman, 2003).

The relative contribution of boat-generated waves to erosion depends on a large number of variables and complex shoreline dynamics which make it difficult to establish effective management strategies. Most management strategies lack a comprehensive procedure to quantify boat-generated wave erosion. The most common management approach is to control boat traffic by enforcing speed limits or with similar restrictions. Wake management criteria reported in the literature are based on restricting the maximum wave height and wave energy regardless of the bank geometry and material composition (Glamore, 2008). In addition to the wave characteristics, the erosion rate due to waves depends on the bank profile, bank material characteristics, vegetation cover, and sediments supply.

In this study, a new boat-wave module to calculate the added shear stress and its contribution to the erosion rate due to boat-generated waves was developed and integrated into the Bank Stability and Toe Erosion Model (BSTEM-Dynamic). Developed at the USDA-ARS National Sedimentation Laboratory, BSTEM-Dynamic is a deterministic bank stability model to calculate factor of safety for multilayer streambanks together with a toe erosion model that estimates hydraulic erosion of the bank using hydraulic shear stress (Simon et al. 1999 and 2000).

The boat-generated wave-erosion model for BSTEM-Dynamic is comprised of three main sub-modules:

1. The boat statistics module which calculates the wave properties such as maximum wave height, wave period, divergent wave angle etc. generated by given boat traffic, using available empirical procedures for boat-induced wave prediction.
2. The connectivity module, which handles the communication between the boat wave statistics and the dynamic bank stability and erosion calculations in BSTEM,
3. Shear-stress module, which estimates the wave-induced shear stress and its contribution to wave erosion.

## Theoretical Background

A boat traveling across the water surface generates water-surface waves that propagate away from the bow. The waves are generated due to the pressure variations between the stern and the bow or boat. The wave pattern consists of symmetrical pairs of divergent waves traveling obliquely out from the sailing line and transverse waves traveling in the direction of the sailing line. The wave train develops as the waves spread out until distinct individual waves are formed. The period of these waves stay constant while their height decrease (attenuate) as they travel away from the bow. Wave period, and direction of divergent wave propagation depend only on the relative vessel speed and water depth whereas wave height is a function of several parameters including the velocity of the flow relative to the vessel, shape of the boat, distance of the boat from the shoreline, channel width and water depth. Hence, even though wave period and direction of wave propagation can be estimated using analytical methods, empirical relations are often needed for wave height estimation.

As the boat moves across the water surface, it pushes the water along its path (sailing line) and creates a pressure rise around the bow. The water level also rises near the bow due to this pressure increase. Deflected water accelerates around the mid-section, reducing the pressure and the water level, and decelerates back at the stern. The pressure rise at the stern is less than the bow due to the flow separation. A wave system is created during this interaction between the boat and water, which can be divided into two components: primary and secondary waves. Primary wave (drawdown) is the single standing wave (relative to the ship) between the bow and the stern (Figure 1). Therefore, the wavelength of the primary wave is in the order of ship length independent of boat speed (Bertram, 2000). The pressure variation between the stern and the bow also causes sinking and trim (Sorensen, 1997). The impact of primary waves on the banks depends on the ratio of the boat cross-sectional area perpendicular to the sailing line, to the river flow cross-sectional area. Primary waves can be neglected for small values of this ratio (Goransson et al., 2013).

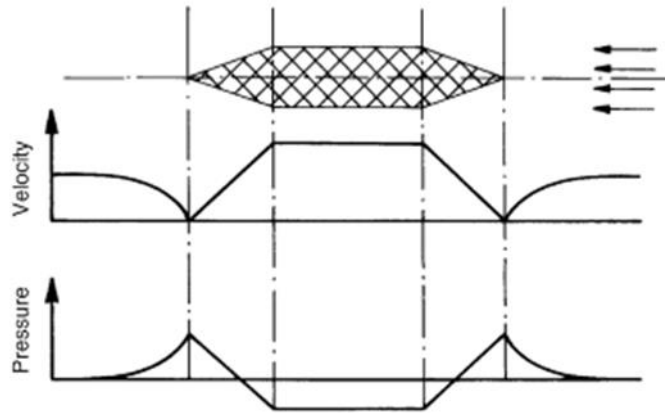
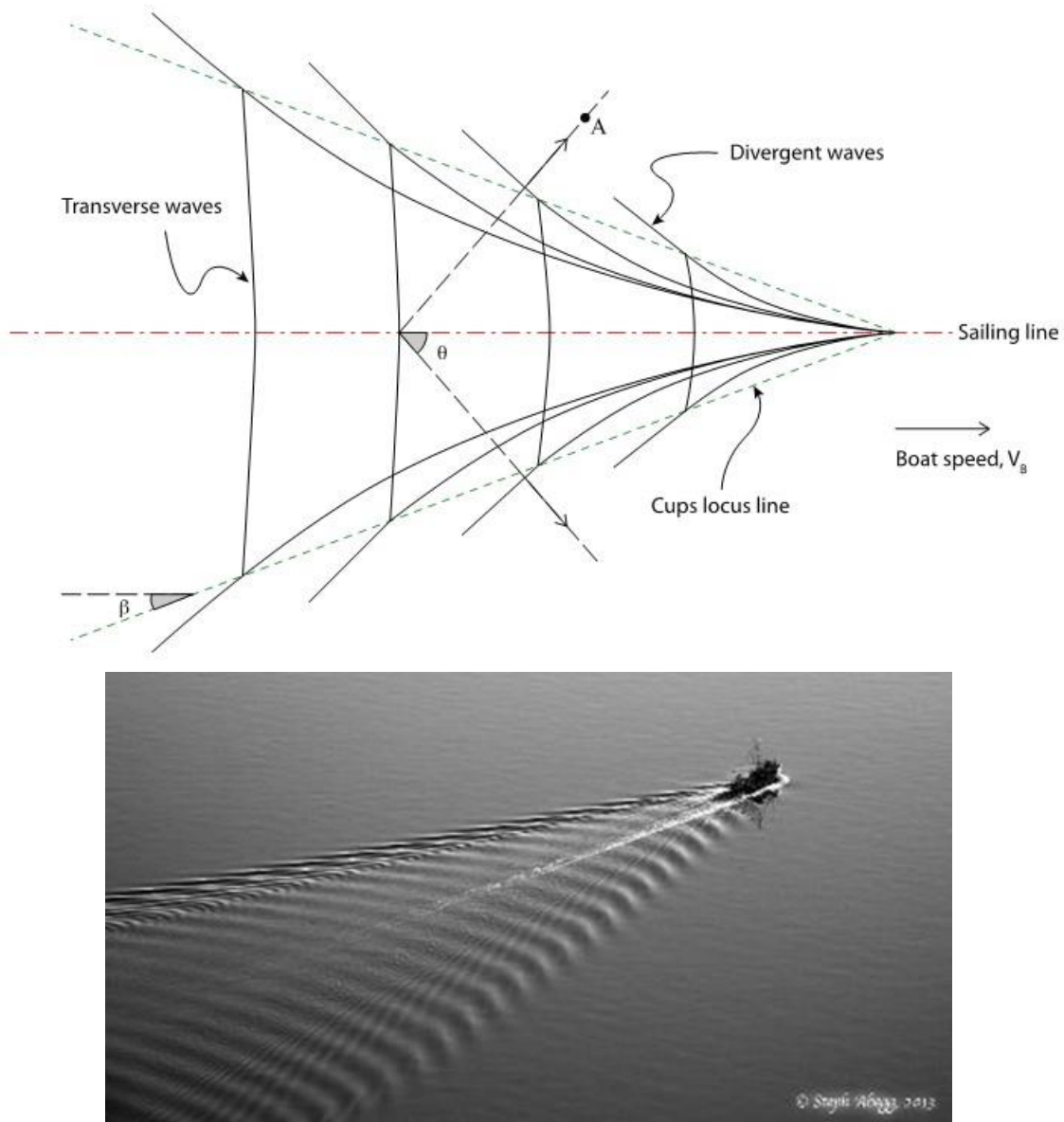


Figure 1. Primary wave system (Bertram, 2000)

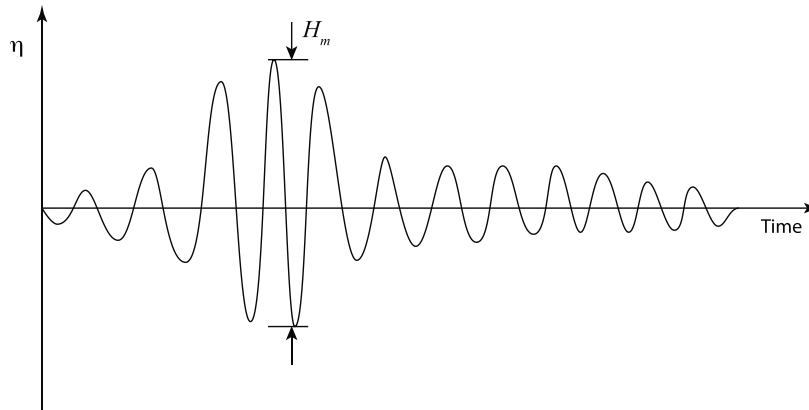
Secondary waves are caused by the disturbances due to the acceleration of the water around the ship (Bertram, 2000). Figure 2 shows the schematics of the secondary waves system in deep water (wave orbital velocities are negligible). Two sets of waves (divergent waves) move out from the sailing line on both sides with an angle  $\theta$ , and a set of waves (transverse waves) move along the sailing line. The interaction of divergent and transverse waves form a line of maximum wave heights, called cups, which extends on each side of the sailing line at an angle of  $\beta$ . In deep water  $\beta = 19.5^\circ$ .  $\theta$  is a function of depth Froude number and  $\theta = 35.3^\circ$  for deep conditions. Both sets of waves attenuate as they travel away from the boat.



**Figure 2. (a) Schematics of a typical secondary wave system in deep water, and (b) ad boat traveling in water (image courtesy of Steph Abegg, <http://www.stephabegg.com>)**

Theoretically, divergent waves attenuate at a rate inversely proportional to the square root of the distance, while transverse waves attenuate at a rate inversely proportional to the cubic root of the distance. Therefore, divergent wave prevail at longer distances (Sorensen, 1997). Inside the cups locus lines, the divergent and transverse waves are out of phase, which results in relatively smaller wave heights.

A typical water surface displacement time series for deep-water waves is illustrated in Figure 3. The wave record measured at point A in deep-water in Figure 2 would look like the plot on Figure 3. The wave record contains small height a long period followed by larger waves of shorter period, which gradually decays to smaller waves. The wave signature of a boat passage is most commonly characterized by the maximum wave height. All wave height prediction models considered here use maximum wave height.



**Figure 3. Typical boat generated wave record in deep water.**

The generated boat waves can be characterized by their wave height,  $H$ , wave period,  $T$ , and the angle they propagate,  $\theta$ . The most significant parameters involved in boat-wave generation can be listed as follows (Figure 4):

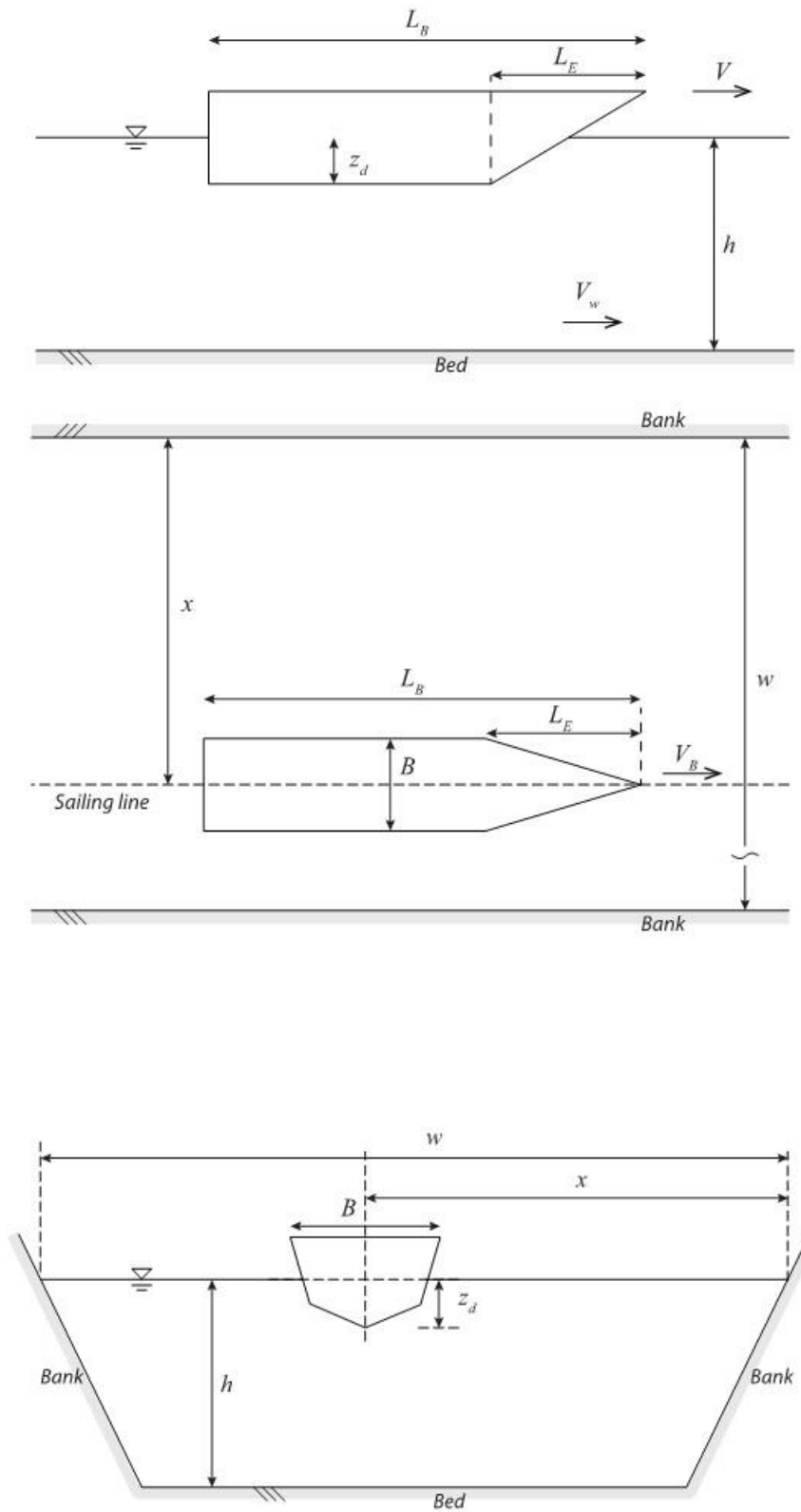
Boat geometry and dynamics:

- Boat length,  $L_B$
- Entrance length,  $L_E$
- Boat width,  $B$
- Boat draft,  $Z_d$
- Displaced volume,  $W$
- Boat speed,  $V_B$
- Relative boat speed ( $V_B - V_C$ ,  $V_C$  is the current velocity)
- Hull design

Channel geometry and flow properties:

- Local water depth,  $h$
- Channel width,  $w$
- Distance from the sailing line,  $x$
- Current velocity,  $V_C$

Northfield Mountain Pumped Storage Project (No. 2485) and Turners Falls Hydroelectric Project (No. 1889)  
 STUDY 3.1.2 NORTHFIELD MOUNTAIN / TURNERS FALLS OPERATIONS IMPACTS ON EXISTING  
 EROSION AND POTENTIAL BANK INSTABILITY



Relative importance of these parameters in terms of wave generation can be characterized by some non-dimensional numbers. Under wave train, water particle velocities decay exponentially with depth. Practically, the wave effect is not felt at the bottom if the water is deeper than half of the wavelength, which is described as ‘deep-water’ conditions. Two different Froude numbers are used to characterize the secondary wave pattern depending on whether it’s deep-water or shallow-water waves. In deep-water, a length based Froude number is defined as:

$$F_L = \frac{V_{BC}}{\sqrt{gL}} \quad (1)$$

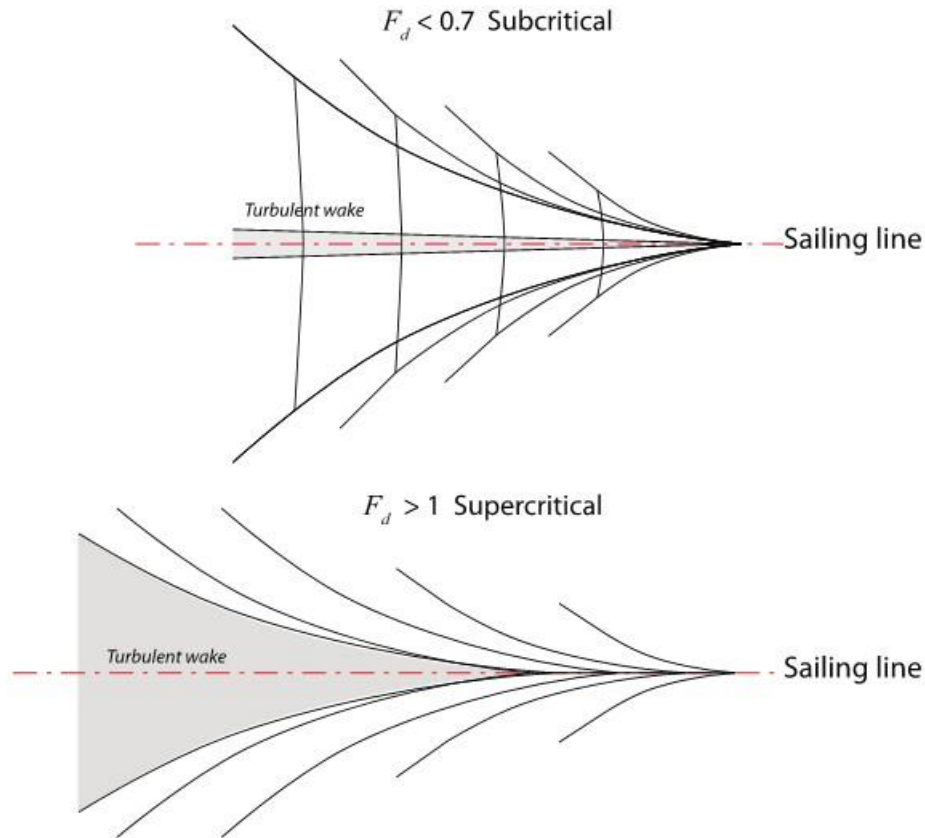
Depth Froude number is defined as

$$F_h = \frac{V_{BC}}{\sqrt{gh}} \quad (2)$$

For small values of depth Froude numbers deep water conditions prevail and for larger values shallow water condition dominate. When  $F_d < 0.7$ , the waves no longer feel the bottom and divergent and transverse waves can be clearly seen (Figure 5a). Divergent wave angle is,  $\theta = 35.3^\circ$ . This is referred as subcritical speeds. As the  $F_d$  increases, the wave heights increase, the waves become more pronounced, and divergent wave angle decreases. The range of  $0.7 > F_d > 1$  is achieved at trans-critical speeds. Since transverse waves are longer, they feel the bottom quicker and their wave heights increase faster. At  $F_d = 1$ , divergent wave angle,  $\theta = 0$  and cups locus angle  $\beta = 90^\circ$ . In restricted channels the wave height can increase more due to diffraction (Sorensen, 1997). The divergent and transverse waves overlap and travel along the sailing line increasing the overall wave height. At Froude numbers equal to unity, another set of waves called solitons can be generated traveling ahead of the boat (Ertekin, 1986). When,  $F_d > 1$  transverse wave no more exist, divergent wave heights are reduced and their angle depend only on Froude number,  $F_h$ . The wave pattern behind the boat becomes more slender, consisting curved lines of divergent waves (Figure 5b). This is called supercritical speeds.

Another Froude scale, Volume Froude number is defined as

$$F_W = \frac{V_{BC}}{\sqrt{gW^{1/3}}} \quad (3)$$



**Figure 5. Secondary wave system for subcritical and supercritical flows.**

Volume Froude number is useful in charactering planing and semi-planing boats (Maynard, 2005, in Tan 2012).

The wave pattern behind the boat does not change with respect to a moving observer with the boat; hence, divergent wave celerity depends on the relative boat speed in the direction of wave propagation.

$$C = V_{BC} \cos \theta \quad (4)$$

Celerity is defined as

$$C = \frac{L}{T} \quad (5)$$

where,  $L$  is the wave length. The relationship between the wave period and the wave length is governed by the dispersion relationship which is defined by:



$$\sigma = gk \tanh(kh) \quad (6)$$

where, wave number  $k$  and wave angular frequency  $\sigma$  are defined as:

$$k = \frac{2\pi}{L} \text{ and } \sigma = \frac{2\pi}{T} \quad (7)$$

therefore

$$C^2 = g \frac{gL}{2\rho} \tanh\left(\frac{2\rho h}{L}\right) \quad (8)$$

Eq. 8 can be solved iteratively for  $L$  and  $T$  using Eq. 5. Note that wave period  $T$  (and wave length  $L$ ), and divergent wave angle,  $\theta$ , depends only on depth Froude number,  $F_h$ , which is a function of relative boat speed,  $V_{BA}$  and local water depth,  $h$ ; therefore, can be calculated analytically if these parameters are known.

Combining Eq. 2, Eq. 4 and Eq. 5, divergent wave angle can be calculated for deep water condition as:

$$\theta = 35.2667 \left(1 - e^{12(F_h^{-1})}\right) \text{ for } F_h < 1 \quad (9)$$

For shallow water conditions,

$$\theta = \frac{\pi}{2} - \arcsin\left(\frac{1}{F_h}\right) \text{ for } F_h > 1 \quad (10)$$

These two functions are plotted in Figure 5 for a range of Froude numbers. In Figure 6, the measured water surface displacements at a fixed location at 2-3 m depth are shown. The wave trains in these plots are quite differed for supercritical and subcritical speeds. Since transverse waves don't exist at supercritical speeds, cups disappear and the wave signal becomes smoother.

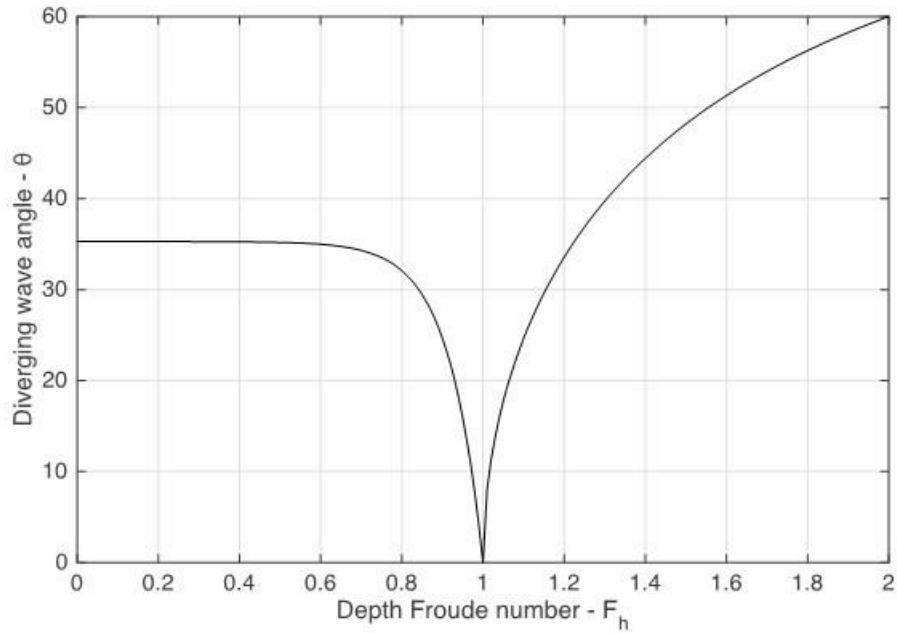


Figure 5. Diverging wave angle as a function of depth Froude number.

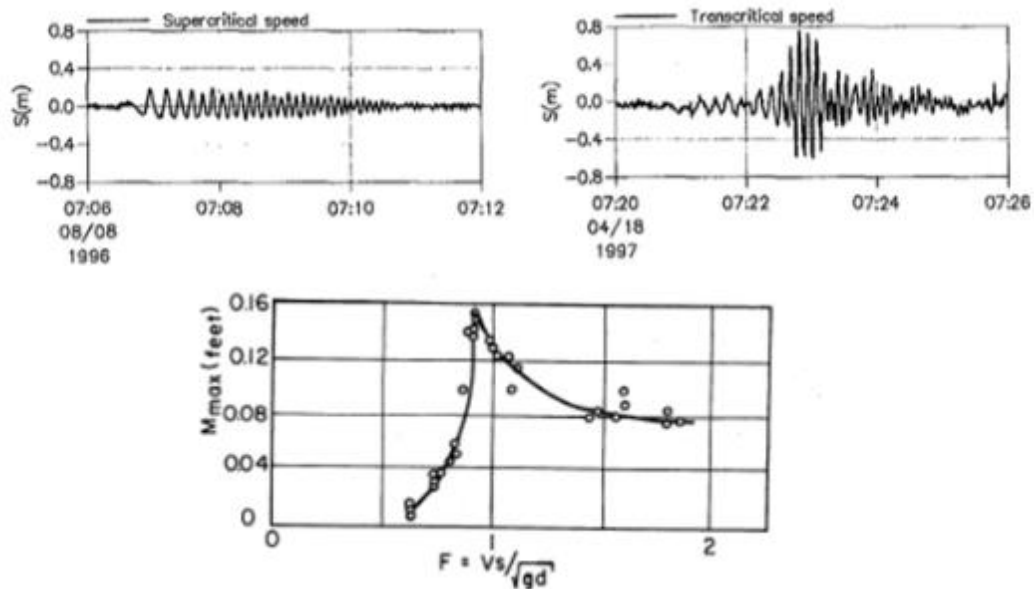


Figure 6. (a) Time series of measured surface elevation in shallow water. Left panel shows the wake wash caused by a high-speed-craft (HSC) operating in the supercritical speed range and the right panel for a transcritical speed. The water depth and distance to the navigation track are 2.4 m and 1500 m (left panel) and 3.2 m and 1100 m (right panel). (b) maximum wave height as a function of depth Froude number (Johnson, 1958)

Waves attenuate as they travel away from the sailing line due to diffraction and spreading. Due to the dispersion nature of progressive waves, longer waves travel faster and separate from the wave train at longer distances. As a result of this, the wave train spread out further from the sailing line. Havelock (1908),

showed that wave heights at cups points decay at a rate inversely proportional to the cubic root of the distance from the sailing line,  $x$ ; whereas transverse waves decay at a faster rate which is inversely proportional to the square of the distance. Therefore the waves at the cups locus lines, which are predominantly divergent waves, can travel longer distances than transverse waves. For divergent waves:

$$H = gx^{\frac{1}{3}} \quad (11)$$

and for transverse waves;

$$H = \gamma x^{\frac{1}{2}} \quad (12)$$

In Figure 6 maximum wave height is plotted against the perpendicular distance from the sailing line (water depth ranging between 10-30 m). Figure 6 clearly shows the exponential decay. These exponents are most accurate at subcritical speeds. Previous research shows some deviation from these values (Macfarlane, 2012).

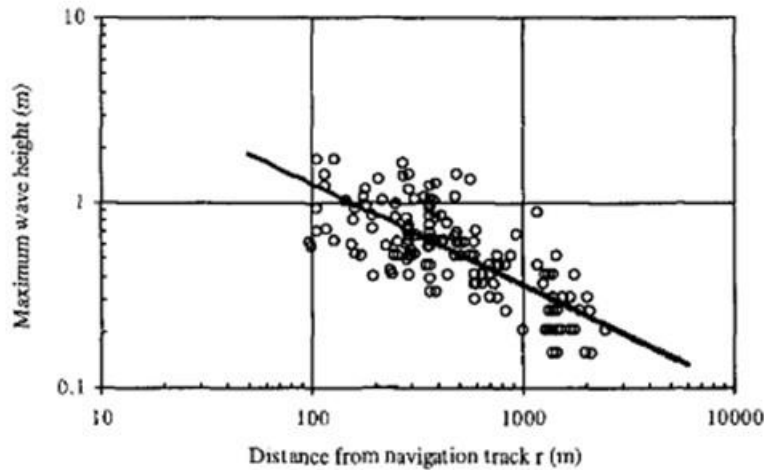


Figure 7. Maximum wave height of the long-periodic waves versus the distance from the ship track. The measured data have been based on various field campaigns involving catamarans only. The trend line (—) is given by  $H_m 16r^{-0.55}$ , where  $r$  (in meters,  $x$  in the current study) denotes the distance from the track. (Kirkegaard, 1998)

### Wave height prediction models

The energy of the wave is related to the square of its wave height. The total energy per wave per unit width of the wave crest according to linear wave theory is

$$E = \frac{1}{8} \rho g H^2 \quad (13)$$

Therefore, wave height is an important parameter in determining the impact of wave on the banks. Unfortunately, boat generated wave height depends on more parameters than the wave period and divergent wave angle. The most common parameter to characterize the wave package as illustrated in Figure 3 is the maximum wave height. Most of the empirical models as well as the available field and experimental data provide the maximum wave height. There has been attempts to characterize the wave package in terms of energy density but there is no widely accepted constrain on the length of the signal to be included in the analysis. The parameters that control the wave height can be listed as follows:

$$H_m = f(V_B, V_c, h, L_B, B, L_e, w, W, z_d, x, A, \dots) \quad (14)$$

The estimation of wave height requires empirical equations. There are several wave height prediction models in the literature. Many of these models predict maximum wave height,  $H_m$  using a subset or all of the parameters listed in Eq. 13. Note that the empirical wave height prediction models are valid only for the data sets that were used in the regression analysis in their derivations. Therefore, they are limited to the boat type and operation conditions the data represent. The models that are used in BSTEM-wave are listed in Table 1. The descriptions, formulations and the limitations of these methods are listed in the following section.

**Table 1. Wave height prediction models the required parameters for each model.**

		h	x	V	L <sub>b</sub>	Z <sub>d</sub>	B	L <sub>E</sub>	W	A
	Method	Water depth	Distance from the shore	Boat speed	Length	Draft	Beam	Hull entrance length	Displaced volume	Hull type coefficient
1	Sorensen and Weggel (1984)	✓	✓	✓	✓	✓	✓		✓	
2	Blaauw et al. (1984)	✓	✓	✓						✓
3	PIANC (1987)	✓	✓	✓						✓
4	Bhowmik et al. (1991)	✓	✓	✓	✓	✓				
5	Kriebel and Seelig (2005)	✓	✓	✓	✓	✓	✓	✓	✓	✓

*Sorensen, R. M., and Weggel, J. R. (1984)*

Sorensen and Weggel (1984) reviewed the available laboratory and filed data at the time on vessel generated, and using this data, they developed a ship wave height predictor model, in the form of a series of empirical equations. The model gives the maximum wave height as a function of the vessel speed and displacement volume, water depth, and distance from the sailing line. This is an interim model that can be used for wave height prediction, but it can be improved upon given improved vessel geometry information. Also, a method is needed to predict the diverging wave period and direction of propagation out from the sailing line (Weggel and Sorensen 1986). The model is valid between  $0.2 < F_h < 0.8$ .

The variables considered in the model are:

$$H_m = f(V_B, h, x, W, L_B, B, z_d) \quad (15)$$

Using dimensional analysis the following dimensionless numbers are defined:

$$H_m^* = \frac{H_m}{W}$$

$$x^* = \frac{x}{W}$$

$$h^* = \frac{h}{W}$$

$$F_h = \frac{V_B}{\sqrt{gh}}$$
(16)

Dimensionless wave height is defined as:

$$H_m^* = \alpha(x^*)^n \quad (17)$$

$$\log \alpha = (a + b \log(d^*)) + c \log(d^*)$$

$$a = \frac{-0.6}{F_h}, \quad b = 0.75 F_h^{-1.25},$$

$$c = 2.653 F_h - 1.95$$

$$n = \beta(h^*)^\delta$$

$$\beta = -2.25 F_h^{-0.699} \quad 0.2 < F_h < 0.55$$

$$\beta = -0.342 \quad 0.55 < F_h < 0.8$$

$$\delta = -0.118 F_h^{-0.356} \quad 0.2 < F_h < 0.55$$

$$\delta = -0.146 \quad 0.55 < F_h < 0.8$$

*Blaauw, H. G., de Groot, M. T., Knaap, F. C. M., and Pilarczyk, K. W. (1984).*

Blaauw et al. (1984) give an equation for predicting the vessel-generated maximum wave height at the bank of a canal, based on Delft Hydraulics Laboratory experiments. The data was collected for a small 18.5 ft long boat passing a wave gauge at various speeds and distances from the gauge. The water was deep enough for deep-water assumption. The maximum wave height is given as a function of the vessel speed, the water depth, and the distance from the sailing line to the bank:

$$H_m = f(V_B, h, x, B, A) \quad (18)$$

The equations are as follows:

$$H_m = Ah \left( \frac{x - B/2}{h} \right)^{-0.33} F_h^{2.67} \quad (19)$$

Values of the coefficient  $A$  for a loaded pushing unit, empty pushing unit, tugboat, conventional inland motor vessel are given in Blaauw et al. (1984).

**Table 2. Coefficient A for Blaauw et la. (1984)**

Boat type	Coefficient A
Conventional inland motor vessel	0.25
Empty pushing unit	0.35
Loaded pushing unit	0.8

**Permanent International Association of Navigation Congresses. (1987).**

Similar to the Blaauw et al. (1984) model, the maximum wave height is given as a function of the vessel speed, the water depth, and the distance from the sailing line to the bank. For relatively low vessel speeds, the two equations yield similar results, but for higher speeds the PIANC equation yields significantly higher results than the DHL equation (Sorensen, 1996).

$$H_m = f(V_B, h, x, B, A) \quad (20)$$

The equations are as follows:

$$H_m = Ah \left( \frac{x - B/2}{h} \right)^{-0.33} F_h^4 \quad (21)$$

**Table 3. Coefficient A for PIANC (1987)**

Boat type	Coefficient A
Tugs, patrol boats, loaded motor boats	1
Empty European barges	0.5
Empty motor boats	0.35

*Bhowmik, N. G., Soong, T. W., Reichelt, W. F., and Seddik, N. M. L. (1991).*

Bhowmik et al (1991) conducted 246 controlled runs using 12 different boats at different sites in the Illinois and Mississippi Rivers. The vessels ranged in length from 3.7 to 14.3 m and included a flat bottom johnboat, a pontoon, a tri-hull, and a variety of V-hulls. The 14.3-m-long cabin cruiser had the maximum draft of 0.76 m. The waves lasted for 6 to 40 seconds during the measurements. The wave heights were measured with a pair of wave gauges set at each of four distances from the sailing line. The results are presented in terms of an empirical equation relating the vessel-generated maximum wave height as a function of the vessel speed, draft, length, and the distance from the sailing line.

$$H_m = f(V_B, h, x, L_B, z_d) \quad (22)$$

The maximum wave height was formulated as:

$$H_m = e^{4.996} V^{0.402} g^{-0.028} V_B^{-0.346} x^{-0.345} L_B^{0.56} z_d^{0.355} \quad (23)$$

Note that although vessel speeds for many of the tests resulted in  $F_h$  greater than 0.7 (many exceeded 1.0), the water depth was not found to be significant in the regression analysis to be included in the empirical equation (Sorensen, 1996).

**Kriebel, D. L., and Seelig, W. N. (2005).**

Kriebel and Seelig (2005) modified the Sorensen and Weggel (1984) model by using a modified Froude number,  $F^*$ . The model is based on previous measurements of boat generated waves from 60 individual vessels and field data collected along the Chesapeake Bay using the USNA Yard Patrol Craft. Maximum wave height was estimated based on the hull geometry, ship block coefficient and bow entry length. The model is limited to  $F_h < 1$  (Tan, 2012).

$$H_m = f(V_B, V_c, h, L_B, B, L_e, w, W, z_d, x) \quad (24)$$

Kriebel and Seelig (2005) defined a modified Froude number as:

$$F_h^* = F_L \exp\left(\alpha \frac{z_d}{h}\right) \quad (25)$$

where

$$\alpha = 2.35(1 - C_B) \quad (26)$$

and the block coefficient is

$$C_B = \frac{W}{L_B B z_d} \quad (27)$$

The maximum wave height is given as:

$$H_m = \beta \frac{V_{BC}^2}{g} (F_h - 0.1)^2 \left(\frac{x}{L_B}\right)^{-1/3} \quad (28)$$

In the above equation,  $\beta$  is the hull form coefficient and defined by:

$$\beta = 1 + 8 \tanh^3\left(0.45\left(\frac{L_B}{L_e} - 2\right)\right) \quad (29)$$

**Wave erosion and sediment transport**

In shallow water conditions, the orbital velocities of the waves near the bed become significant. The waves exert a shear force on the bed material. Wave related bed shear stress depends on the horizontal orbital velocity and the friction factor. The maximum horizontal velocity near the bed can be calculated based on linear wave theory:



$$U_w = \frac{\pi H_m}{T \sinh(kh)} \quad (30)$$

or, using Eq. 7:

$$U_w = \sigma A_w \quad (31)$$

where the pea orbital excursion  $A_w$  is defined as

$$A_w = \frac{H_m}{2 \sinh(kh)} \quad (32)$$

The peak bed shear stress is defined by:

$$\tau_w = \frac{1}{2} \rho f_w U_w \quad (33)$$

Note that, since  $U_w$  is oscillates, the bed shear stress also oscillates and changes direction. The friction factor in the  $f_w$  is assumed to be constant over the wave cycle (Rijn, 1993). The definition of the friction factor varies based on the flow conditions which can be characterized by the wave Reynolds number:

$$Re_w = \frac{U_w h}{\nu} \quad (34)$$

The hydrodynamically smooth and rough conditions are defined by (Jonsson, 1966, 1980):

- Smooth turbulent flow:  $10^4 < Re_w < 10^6$  and  $A_w/k_s > 10^3$
- Rough turbulent flow:  $10^5 < Re_w$  and  $A_w/k_s < 100$

Note that only turbulent friction factor is used in this study.

where  $k_s$  is the roughness height and be approximately calculated using median grain diameter (Madsen et al., 1993):

$$k_s = 15d_{50} \quad (35)$$

For smooth turbulent flow, the friction factor is defined as (Rijn, 1993):

$$f_{ws} = 0.9 Re_w^{-0.2} \quad (36)$$

For rough turbulent flows (Swart, 1976)

$$f_{wr} = \exp\left(-6 + 5.2\left(\frac{A_w}{k_s}\right)^{-0.19}\right) \quad (37)$$

In the existence of both current and the waves, the total bed shear stress  $\vec{\tau}_T$  has two components: the oscillating wave related bed shear stress  $\vec{\tau}_w$ , and flow current related bed shear stress  $\vec{\tau}_c$ . Therefore, total shear stress is also time dependent and oscillates in a wave cycle. Neglecting the nonlinearities due to turbulence (Soulsby and Clarke, 2005), at any time,  $t$  the total bed shear stress is given by the vector sum of the two:

$$\vec{\tau}_T(t) = \vec{\tau}_c + \vec{\tau}_w(t) \quad (38)$$

The vector summation of the shear stress components is illustrated in Figure 8. Using sinusoidal assumption, maximum, root-mean-square and mean shear stresses defined as:

$$\tau_{\max} = \sqrt{(\tau_c + \tau_w|\cos\theta|)^2 + (\tau_w|\sin\theta|)^2} \quad (39)$$

$$t_{rms} = \sqrt{t_c^2 + \frac{1}{2}t_w^2} \quad (40)$$

$$\tau_{mean} = \tau_c \quad (41)$$

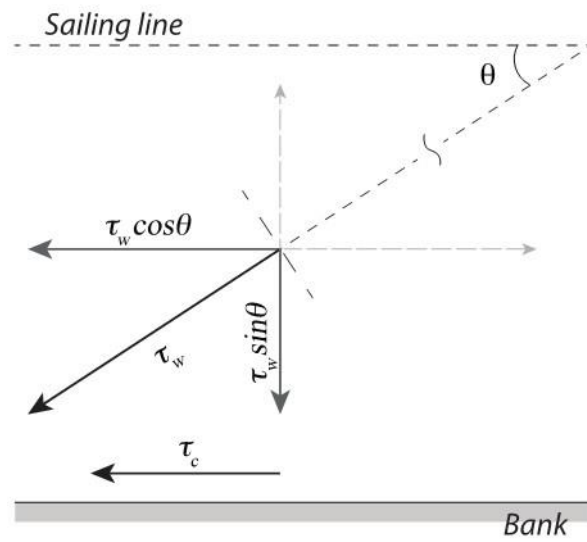


Figure 8. Definition of the current and wave related bed shear stress components.

### Implementation into BSTEM and programming

The new boat-wave module implemented in BSTEM calculates boat wave properties based on a boat passage table, and using the calculated wave properties, estimates the added shear stress and its contribution to the erosion rate.

The boat-generated wave erosion model consists of three main sub-modules as formerly described:

1. **The boat statistics module:** Calculates the wave properties ( $H_m$ ,  $T$ ,  $\theta$ ) for each boat passage for a given boat traffic, using an available five empirical models described in the previous section. The boat statistics module also includes a sub-module to calculate the local water depth and average flow velocity for a given cross-section, energy slope.
2. **Connectivity module:** Generates the pointer array that links the boat traffic data to the flow time series. These pointer arrays enable two-way communication between BSTEM and BSTEM-wave.
3. **Shear-stress module:** Using the boat wave properties calculated by the boat statistics module, the estimates the wave-induced shear stress and its contribution wave erosion.

The subroutines of the modules described above are listed in Table 4. A flowchart is presented in Figure 9 to summarize the integration map for BSTEM-wave.

**Table 4. List of major subroutines included in BSTEM-wave**

Subroutine	Description
ReadWaveData	Reads the boat passage data in the 'Boat Waves' worksheet and calculates the generated wave properties
BoatTimeConnect	Generates two connectivity arrays using the Date/time column in the 'Boat Waves' input worksheet and the flow Date/time in the 'calculations' worksheet
SailingLineHydro	Calculates the local water depth at the sailing line, and average flow velocity based on cross-section and stage data, calculation are done for each boat passage
waveCalculations	Calculates the wave properties for a given boat passage
WaveShearStress	Calculates the bed shear stress due to waves at a given water depth
wlength	Calculates the wave length for a given wave period based on dispersion relationship

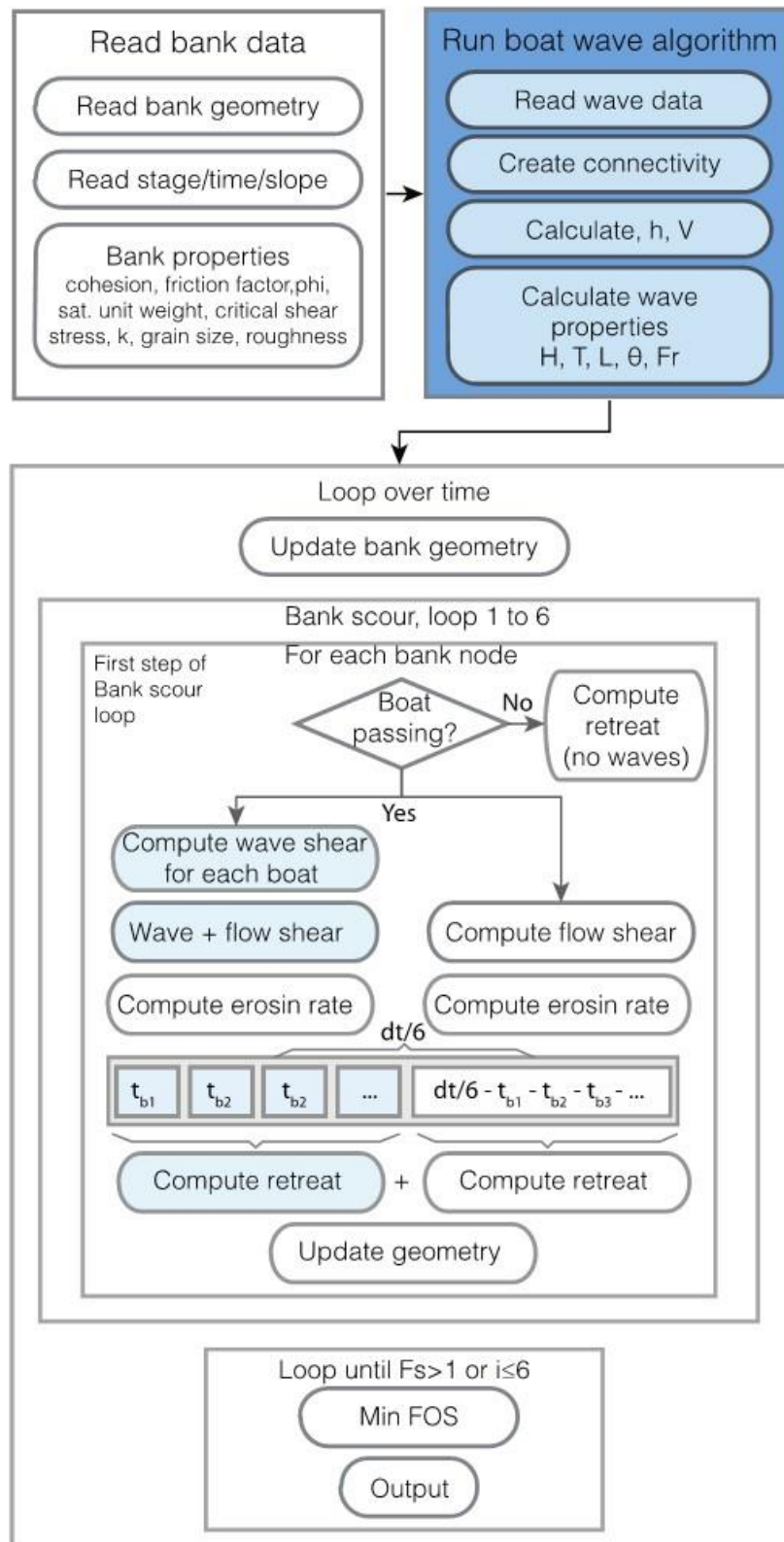
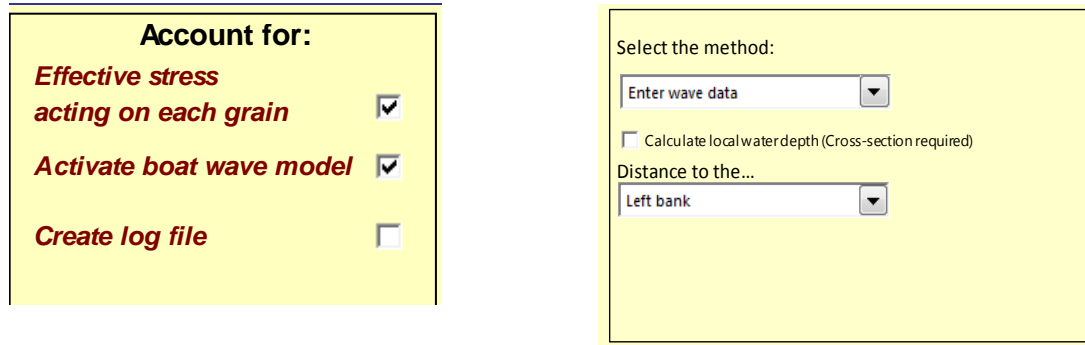


Figure 9. Definition of the current and wave related bed shear stress components



**Figure 10. (a) Checkbox to activate the boat wave model in the input geometry worksheet, (b) pull down menus for the selection of wave height and local water depth calculation.**

The wave height calculation method can be selected using the pull down menu as shown in Figure 10b. Only the necessary columns for the selected model are displayed in the boat traffic input table. If the local water depth and average flow velocity is not readily available, the user can activate the ‘sailingLineHydro’ subroutine to calculate these parameters. Cross-section coordinates are required for the calculation of the average velocity and local water depth, which must be entered in ‘Cross Section’ worksheet. The bank that is being calculated on the cross-section must be specified by user the ‘left bank- right bank’ pull down menu. Left bank is the bank to the left of the observer looking downstream. Boat traffic is inserted in the ‘Boat Waves’ worksheet in ascending order.

The wave model is activated by the ‘boat wave model’ checkbox in the ‘input geometry’ worksheet. If the wave model is activated, BSTEM model first reads the input bank geometry, bank material properties and flow time series, and then executes the ‘ReadWaveData’ to read the entire boat traffic table in the ‘Boat Waves’ worksheet (Figure 9).

Before the program loops in time, the connectivity between the boat wave statistics and the flow time series is calculated. The connectivity module links the boat passages to each flow time step assuming the flow time step  $\Delta t$  is much larger than boat time step  $\Delta t_b$ . If there no boat passages at a given time step, then the model skips the boat wave shear stress calculation. On the other hand, if multiple boats pass at a given time step, the wave shear stress is calculated for each boat passage, total boat wave induced erosion is calculated and added on top of the on top of the flow erosion. The connectivity is illustrated in the schematic diagram in Figure 9.

The total shear stress is the vector sum of the wave shear stress and the flow shear stress. Whenever the boat wave shear stress calculation is active, both,  $\vec{\tau}_w$  and  $\vec{\tau}_c$  are calculated at every bank node, and added using to the relations given in the previous section. A typical continuous distribution of  $\vec{\tau}_{w\max}$  and  $\vec{\tau}_c$  is shown in Figure 11. Note that wave shear is maximum close to the surface whereas flow shear maximizes near the bed. For the erosion rate calculation, wave shear stress is applied for  $8T_j$ , where  $T_j$  is the wave period of the  $j^{\text{th}}$  boat wave in the current time step.

Upon completion of the simulation, the wave properties and wave shear stress parameter are written in the ‘boat waves’ worksheet. A list of output parameters and their definitions can be found in Table 5.

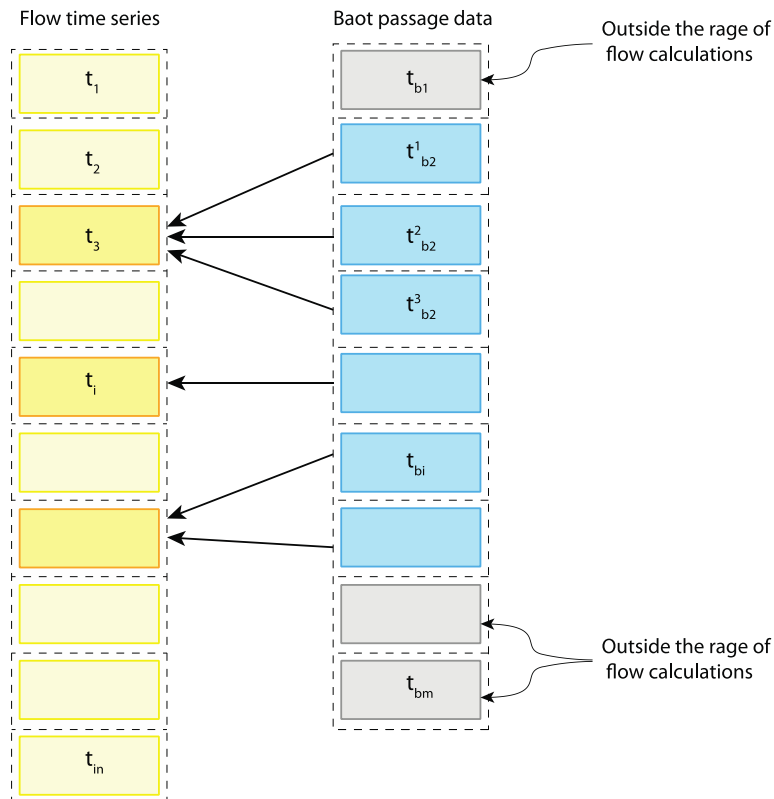


Figure 11. Schematic description of the connectivity between flow time series and boat passage data.

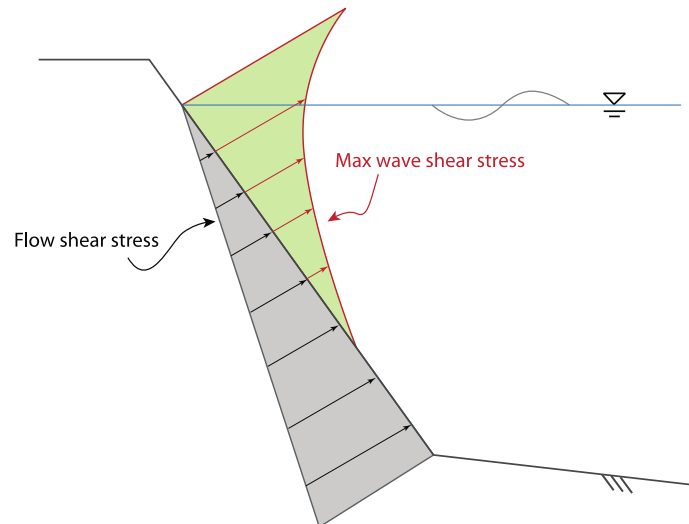


Figure 12. Wave and flow shear stress distributions on the bank.

**Table 5. Wave and flow shear stress distributions on the bank.**

Output parameter	Unit	Definition
Wave period, $T$	(s)	The period of the divergent waves
Wave length, $L$	(m)	Wavelength near the boat
Maximum wave height, $H_m$	(m)	Maximum wave height at the bank (at a distance of $x$ from the sailing line)
Diverging wave angle, $\theta$	(deg)	The angle that the waves approach to the shore
Length Froude number, $F_L$	[-]	Length Froude number
Depth Froude number, $F_h$	[-]	Depth Froude number
Volume Froude number, $F_w$	[-]	Volume Froude number
Max. max. wave shear stress	Pa	The highest of the of the wave-induced shear stress amplitude along the bank nodes
Max. RMS wave shear stress	Pa	The highest of the of the rms wave-induced shear stress along the bank nodes
Flow shear at Max. wave shear stress	Pa	Corresponding flow shears stress at the Max. max. wave shear stress node.
Wave shear duration	s	Total time of application of the wave shear stress on the bank
Max flow shear stress (Pa)	Pa	Max. flow shear stress on the bank nodes
Total max wave momentum	kg/s	A momentum scale calculated by $M_{wmax} = \sum_j \tau_{maxj} \Delta t_w  \Delta \vec{x} _j, j \text{ is the bank node index}$
Total rms wave momentum	kg/s	A momentum scale calculated by $M_{wrms} = \sum_j \tau_{rmsj} \Delta t_w  \Delta \vec{x} _j$
Total flow momentum	kg/s	A momentum scale calculated by $M_c = \tau_c t \Delta t_c  \Delta \vec{x} $
Total momentum	kg/s	A momentum scale calculated by $M_T = M_c + M_{wrms}$



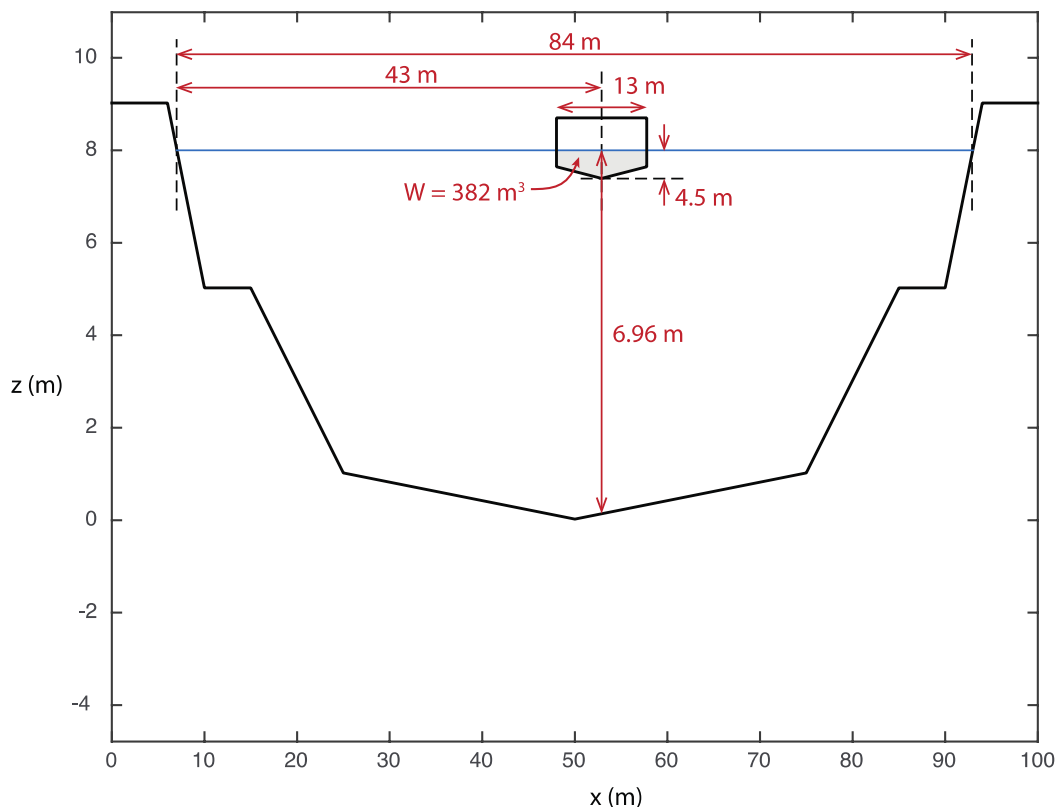
**Example solution**

The model is tested for an artificial bank material properties and a boat passage data on a simple cross-section. In the example a single boat moved 9 times a day, every two hours from 8:00am. Sorensen and Weggel (1984) model was used for wave height prediction. The boat properties are shown in Table 6. The cross-section is plotted in Figure 12.

Bank material is selected as medium silt for all the layers. Simulations with different combinations of parameters were carried out: current only, wave only, current + wave with energy slope = 0.0005 – 0.001, boat speeds 4 m/s, 5 m/s and 6m/s. The flow elevation was 8 m and time step size was 1 day for all of the simulations.

**Table 6. Boat properties.**

Local water depth	Distance to the shoreline	Length	Draft	Beam	Hull entrance length	Displaced volume	Hull type coeff.
(m)	(m)	(m)	(m)	(m)	(m)	(m <sup>3</sup> )	[-]
6.96	42	88	4.5	13	13	382	0.2



**Figure 12. Definition sketch of the example solution.**

The results of the simulations are compared in Figures 13 through 17. Figure 13 compares 1-month-long simulations with energy slopes of 0.0005 and 0.01, and 2 months long simulation with an energy slope of

0.01. The purpose of these simulations was to test the normal operation of the updated BSTEM model. The boat wave algorithm is not activated in these simulations.

In order to isolate the boat wave algorithm, the energy slope is set to a very small value and the boat data in Table 6 is applied 9 passes a day for 2months. The simulations were carried out at three different boat speeds 4 m/s, 5m/s and 6m/s. Figure 14 shows the comparison of the eroded profiles with waves. Also, in Table 7 the input and output wave properties are listed.

In Figure 15, both toe erosion and boat wave erosion algorithms are activated at  $S_0 = 0.0005$ . The undercutting boat by the wave and current actions can be seen clearly. No bank failure was observed for this case. When the energy slope is steeper in Figure 16, bank failure was observed for the 2-month period.

Finally, one and two month simulations with and without the boat wave model are plotted in Figure 17, the boat wave data was 1-month-long for all of the simulations in this plot. It can be seen in the figure that, bank retreat without the boat waves appears to be faster than the case with the waves. This counterintuitive result is can be explained as follows: wave erosion is highest close to the water surface, hence expected to be at a higher elevation compared to the toe erosion. Eroded material reduces the weight of the block, therefore increases factor of safety. Further research is needed to understand the physical basis of the phenomenon.

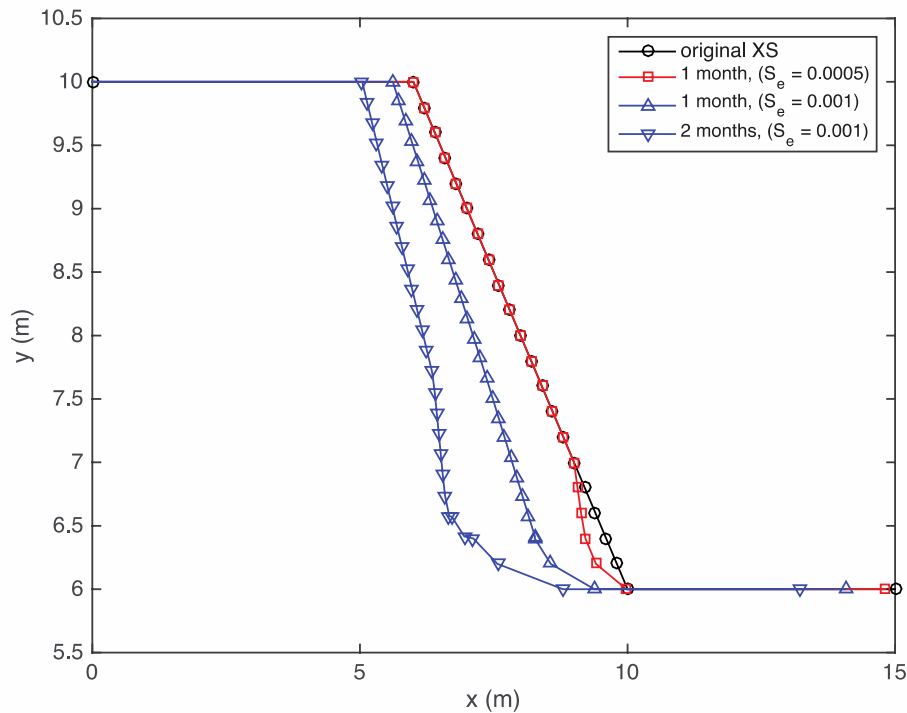


Figure 13. Eroded bank profile without boat waves.

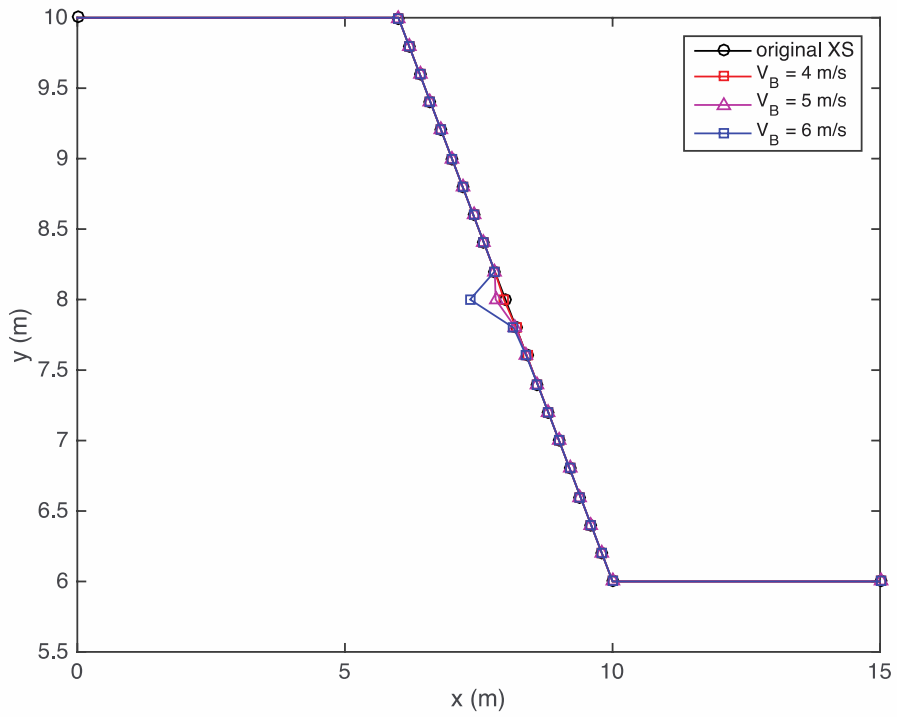


Figure 14. Eroded bank profile with boat waves only.

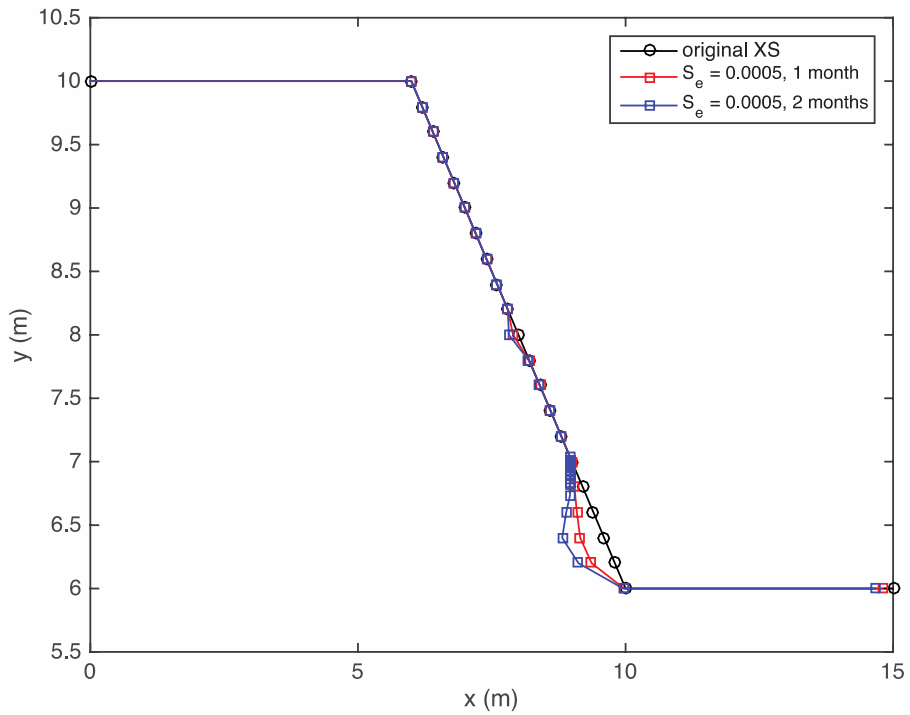
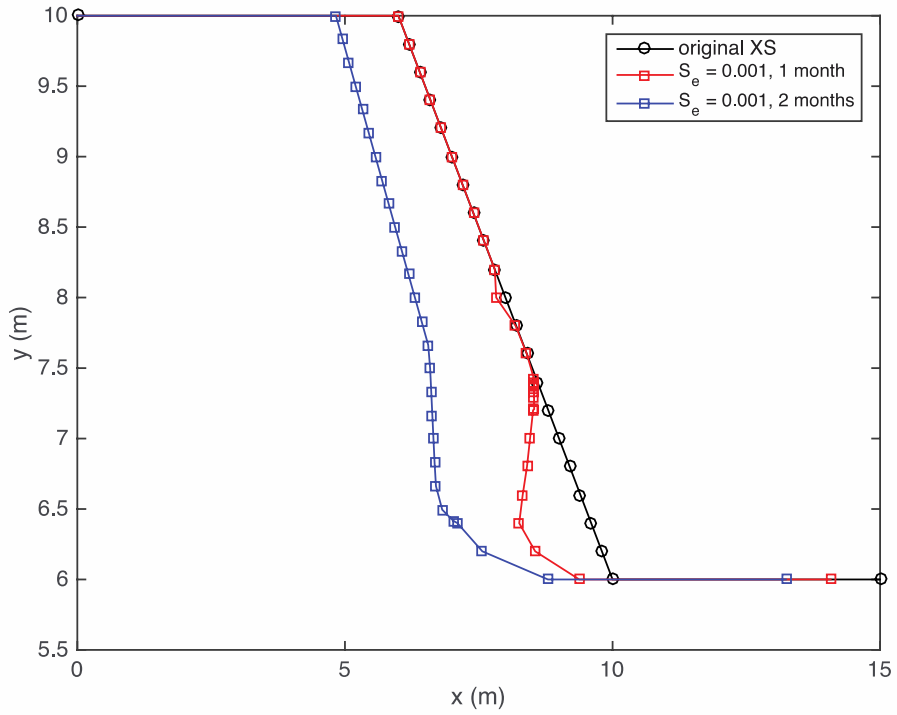
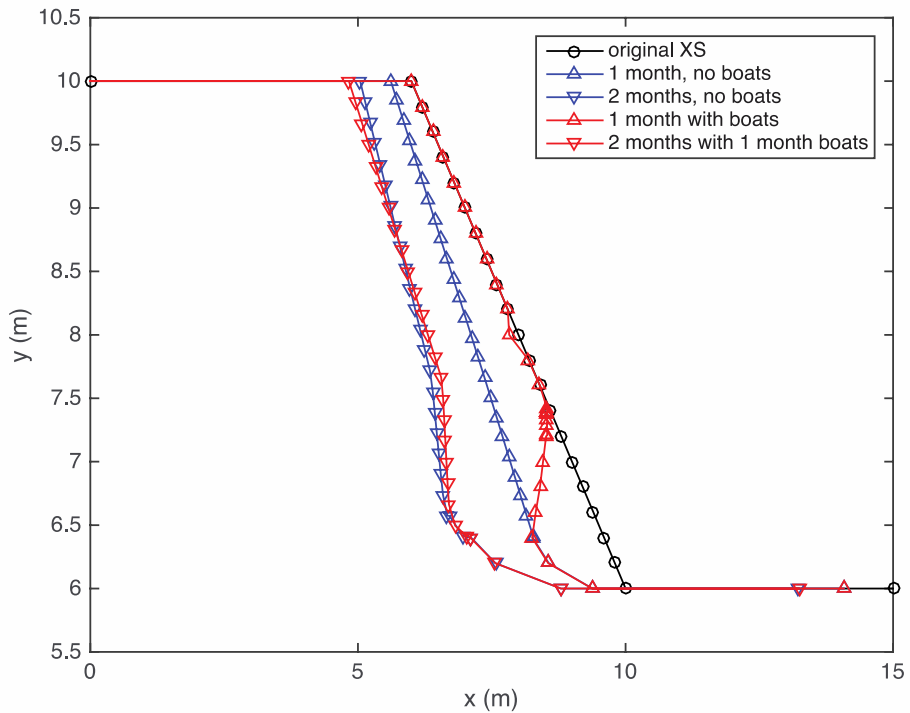


Figure 15. Boat wave erosion and toe erosion at  $S_0 = 0.0005$ .



**Figure 16. Bank erosion for 1 month and 2 month simulation periods.**



**Figure 17. Comparison of failure profiles with and without boat waves.**

Northfield Mountain Pumped Storage Project (No. 2485) and Turners Falls Hydroelectric Project (No. 1889)  
 STUDY 3.1.2 NORTHFIELD MOUNTAIN / TURNERS FALLS OPERATIONS IMPACTS ON EXISTING  
 EROSION AND POTENTIAL BANK INSTABILITY

**Table 6. Simulations results**

Ground speed	(m/s)	6	5	4
Average flow velocity	m/s	0.000413	0.000413	0.000413
Distance to the shoreline	(m)	43	43	43
Length	(m)	88	88	88
Draft	(m)	4.5	4.5	4.5
Beam	(m)	13	13	13
Hull entrance length	(m)	13	13	13
Displaced volume	(m <sup>3</sup> )	382	382	382
Local water depth	(m)	6.96	6.96	6.96
Average flow velocity	m/s	0.000413	0.000413	0.000413
Distance to the shoreline	(m)	43	43	43
Ground speed	(m/s)	6	5	4
Length	(m)	88	88	88
Draft	(m)	4.5	4.5	4.5
Beam	(m)	13	13	13
Hull entrance length	(m)	13	13	13
Displaced volume	(m <sup>3</sup> )	382	382	382
Wave period	(s)	3.20	2.63	2.09
Wave length	(m)	15.94	10.76	6.84
Maximum wave height	(m)	0.53	0.36	0.19
Diverging wave angle	(deg)	33.95	34.96	35.19
Length Froude number	[-]	0.204	0.170	0.136
Depth Froude number	[-]	0.726	0.605	0.484
Volume Froude number	[-]	0.711	0.593	0.474
Max. max wave shear stress	Pa	1567.96	541.07	112.24
Max. RMS wave shear stress	Pa	1108.71	382.59	79.36
Flow shear at Max. wave shear stress	Pa	0.00	0.00	0.00
Wave shear duration	s	25.62	21.01	16.75
Max flow shear stress (Pa)	Pa	0.18	0.18	0.18
Total max wave momentum	kg/s	7401.15	2112.39	363.87
Total rms flow momentum	kg/s	5217.03	1482.65	255.86
Total flow momentum	kg/s	30.15	24.72	19.72

## REFERENCES

- Sorensen, R. M., and Weggel, J. R. (1984). Development of ship wave design information. Proceedings of the 19th Conference on Coastal Engineering, Houston, TX, 3-7 September 1984. Billy L. Edge, ed., American Society of Civil Engineers, New York, III, 3227-43.
- Kriebel, D. L., and Seelig, W. N. (2005). "An empirical model for ship-generated waves." Proc., 5th Int. Symp. on Ocean Wave Measurement and Analysis (CD-ROM), Madrid, Spain
- Bhowmik, N. G., Soong, T. W., Reichelt, W. F., and Seddik, N. M. L. (1991). AWaves generated by recreational traffic on the Upper Mississippi River system, @ Research Report 117, Department of Energy and Natural Resources, Illinois State Water Survey, Champaign, IL.
- Blaauw, H. G., de Groot, M. T., Knaap, F. C. M., and Pilarczyk, K. W. (1984). ADesign of bank protection of inland navigation fairways. @ Proceedings of the Conference on Flexible Armoured Revetments Incorporating Geotextiles, London, 29-30 March 1984. Thomas Telford, 239-66.

# **APPENDIX H – SUPPLEMENTAL BOAT WAVE DATA (1997 & 2008)**

### **SUPPLEMENTAL BOAT WAVE DATA 1997 & 2008**

Boat wave data were collected by Simons & Associates in May and July 1997 and July 2008. In May 1997, data were collected at the Flagg site in the vicinity of Transect 6A; and in July 1997 data were collected just downstream of the Route 10 Bridge adjacent to Bennett Meadow. These data included video photography of boat waves with a staff gage and collection of suspended sediment samples. In July 2008, boat wave data were collected on the right bank in the vicinity of the Northfield Mountain tailrace. Data collection included video photography of boat waves.

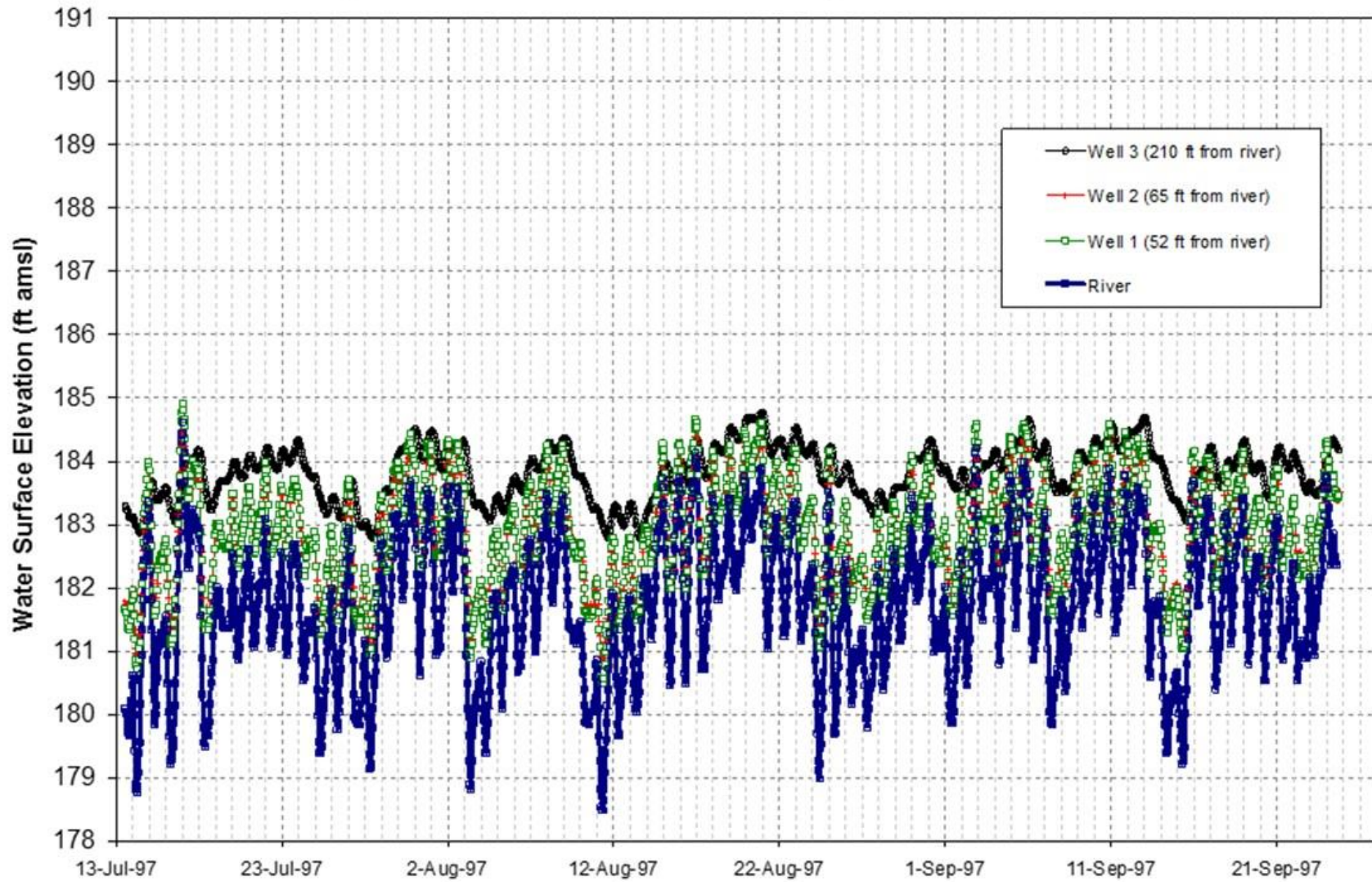
These data were previously distributed to the stakeholders via email on March 31, 2015 and filed with FERC on May 26, 2015.



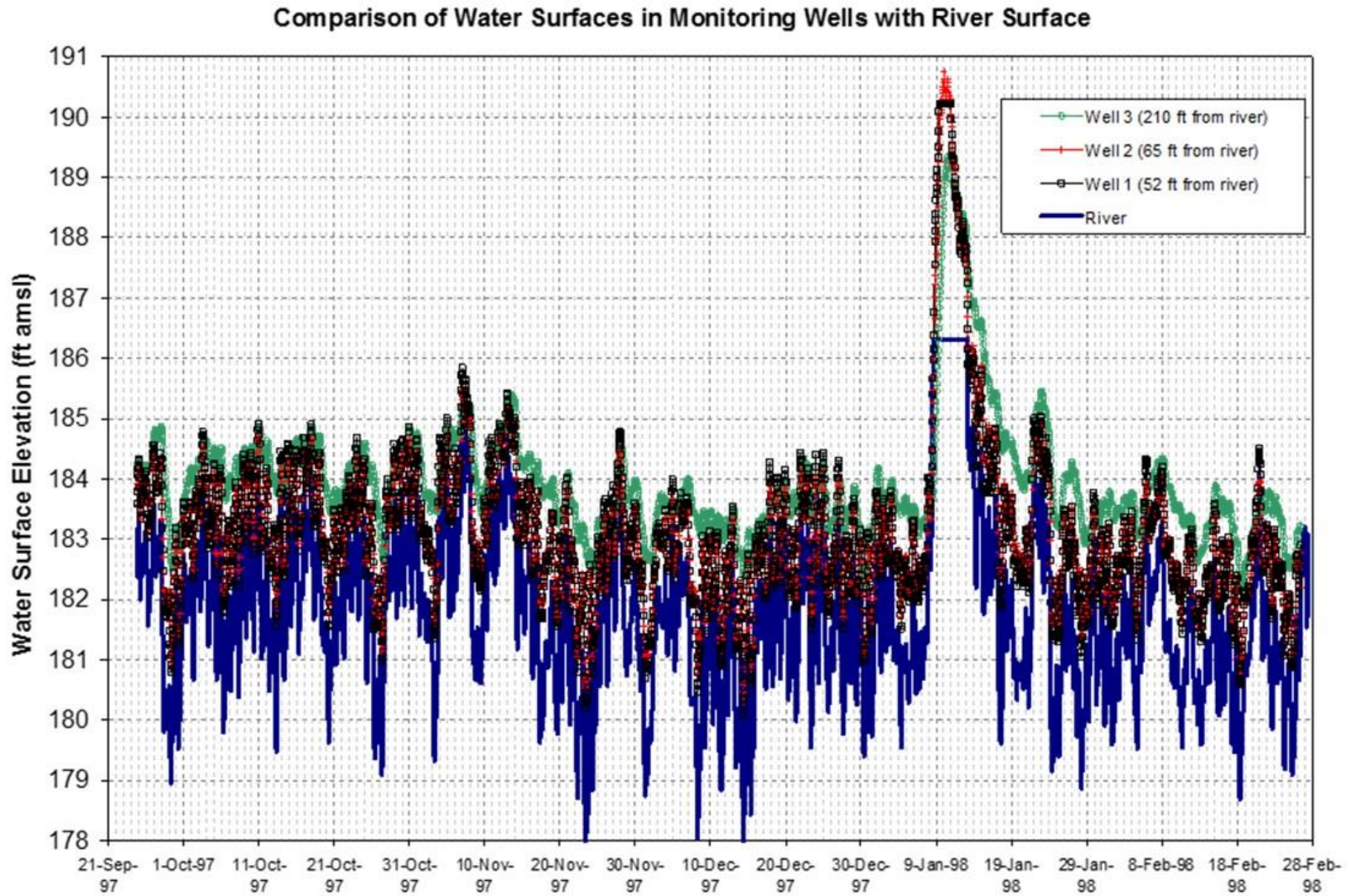
# **APPENDIX I – SUPPLEMENTAL GROUNDWATER DATA (1997-1998)**

STUDY 3.1.2 NORTHFIELD MOUNTAIN / TURNERS FALLS OPERATIONS IMPACTS ON EXISTING EROSION AND POTENTIAL BANK INSTABILITY

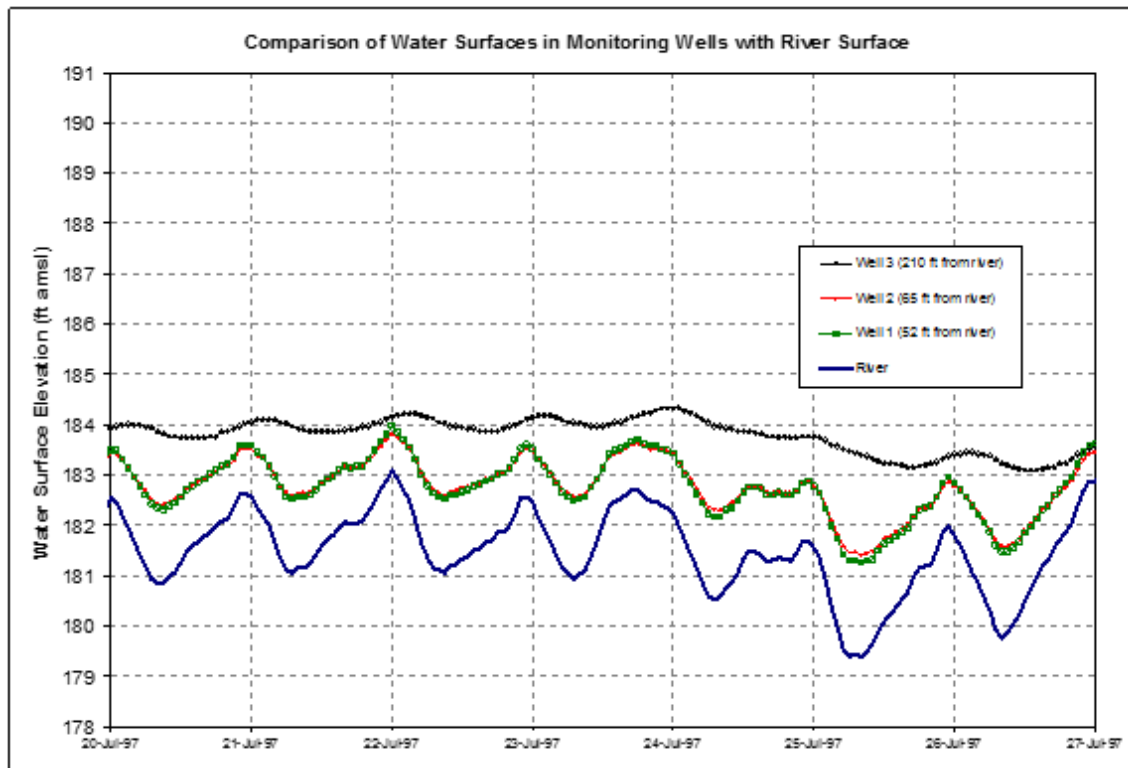
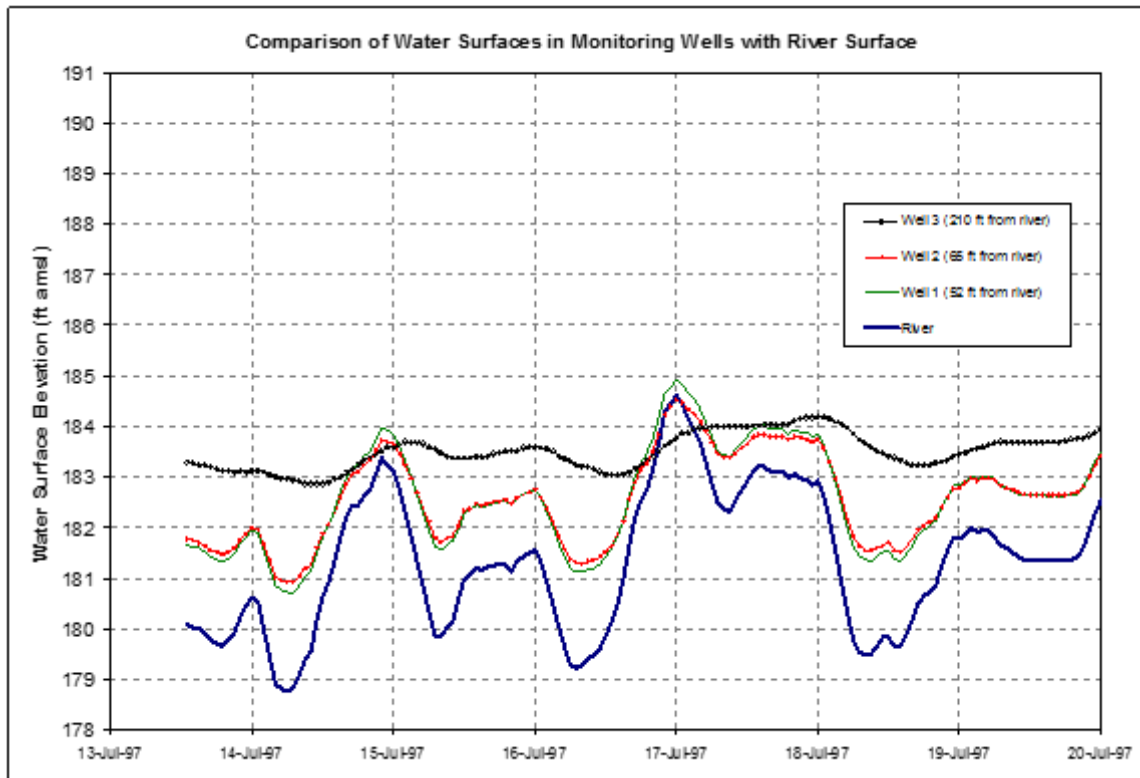
Comparison of Water Surfaces in Monitoring Wells with River Surface



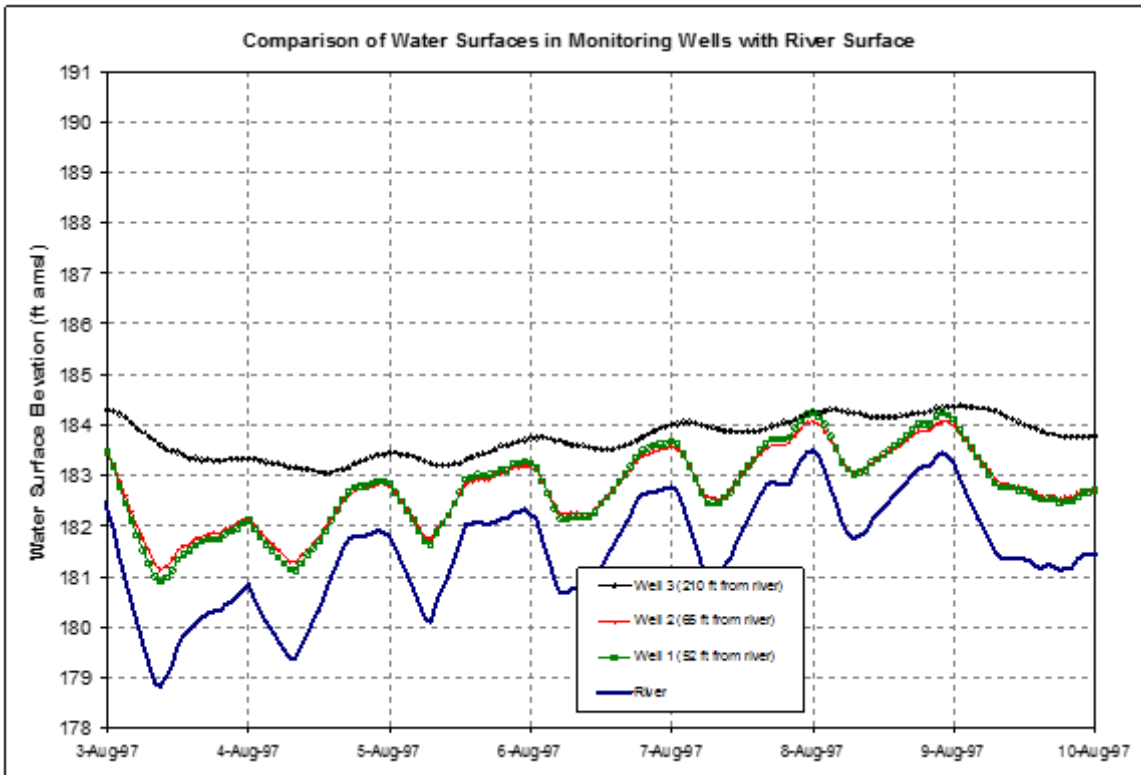
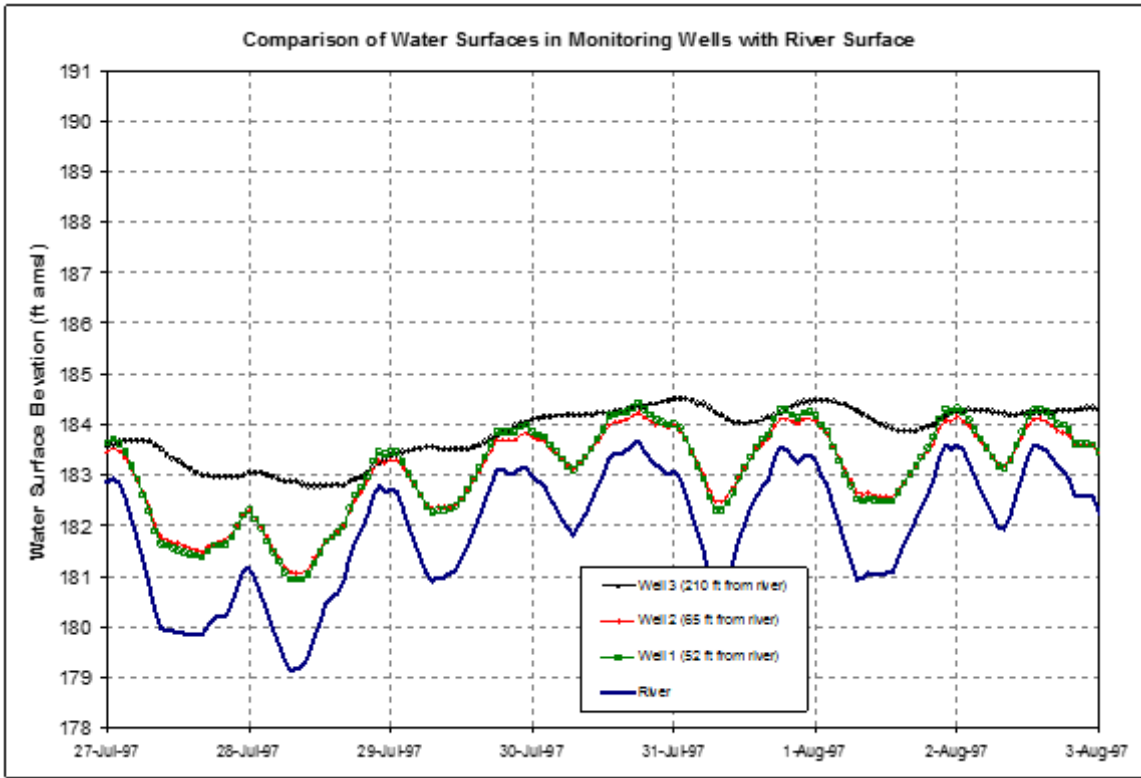
STUDY 3.1.2 NORTHFIELD MOUNTAIN / TURNERS FALLS OPERATIONS IMPACTS ON EXISTING EROSION AND POTENTIAL BANK INSTABILITY



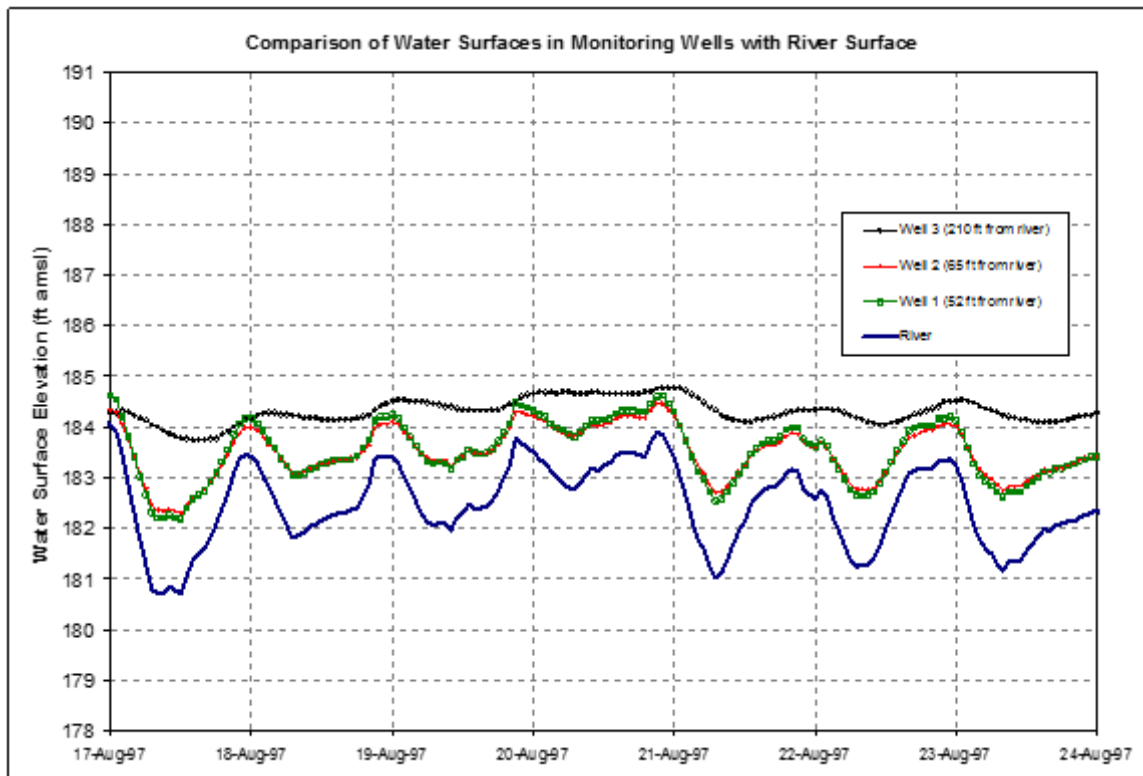
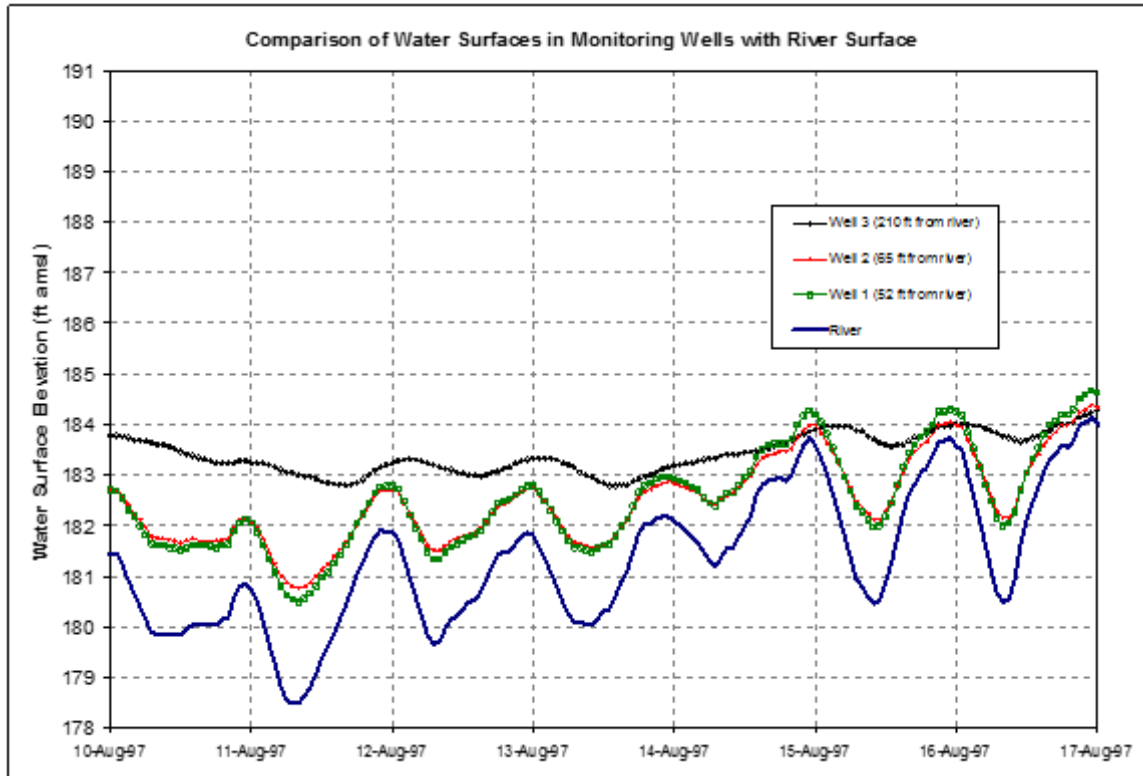
Northfield Mountain Pumped Storage Project (No. 2485) and Turners Falls Hydroelectric Project (No. 1889)  
STUDY 3.1.2 NORTHFIELD MOUNTAIN / TURNERS FALLS OPERATIONS IMPACTS ON EXISTING  
EROSION AND POTENTIAL BANK INSTABILITY



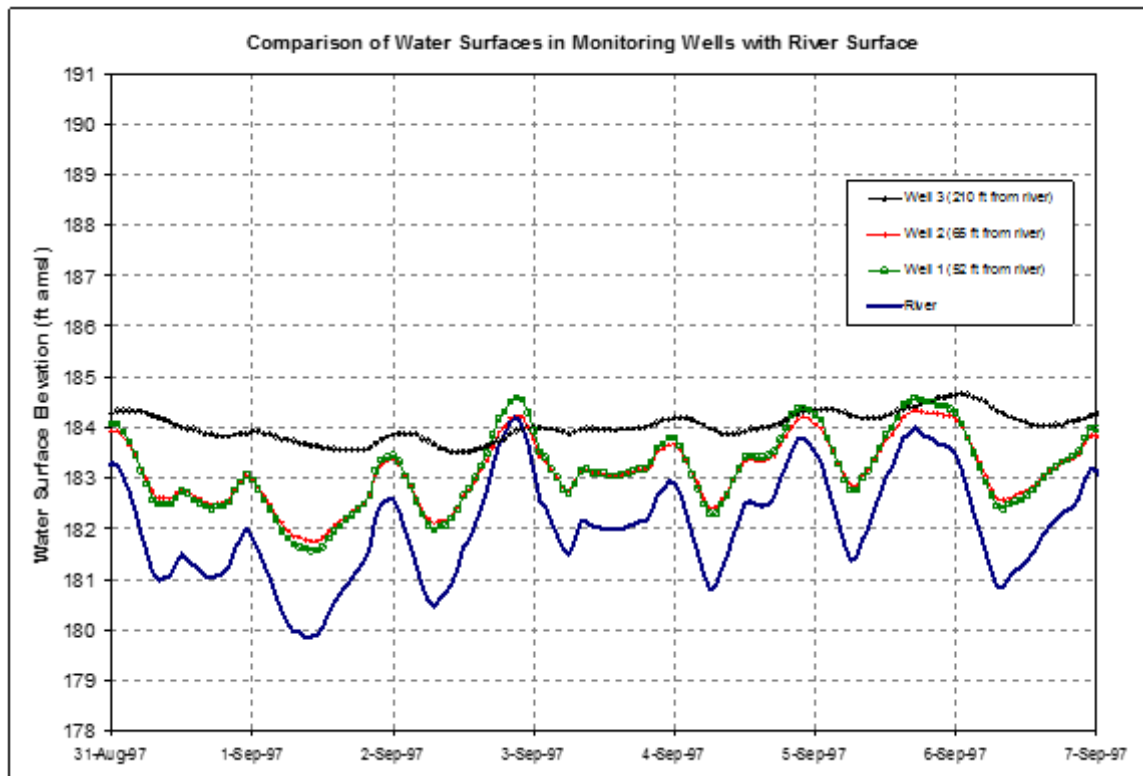
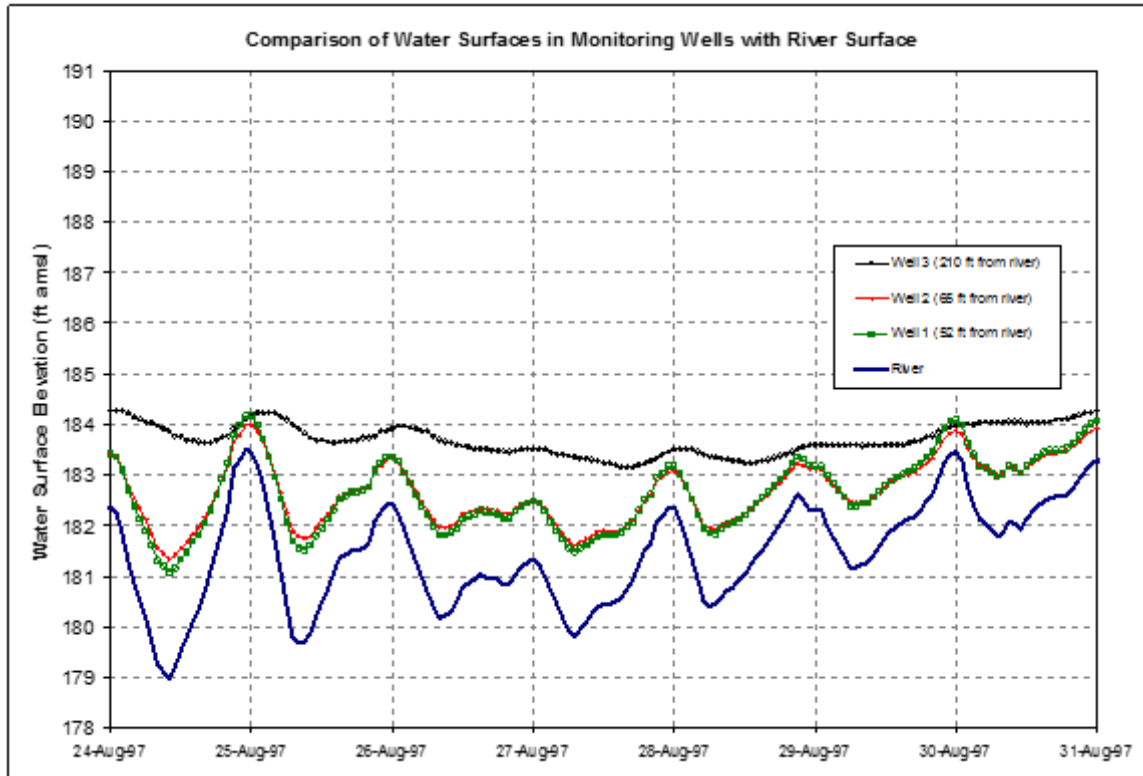
Northfield Mountain Pumped Storage Project (No. 2485) and Turners Falls Hydroelectric Project (No. 1889)  
STUDY 3.1.2 NORTHFIELD MOUNTAIN / TURNERS FALLS OPERATIONS IMPACTS ON EXISTING  
EROSION AND POTENTIAL BANK INSTABILITY



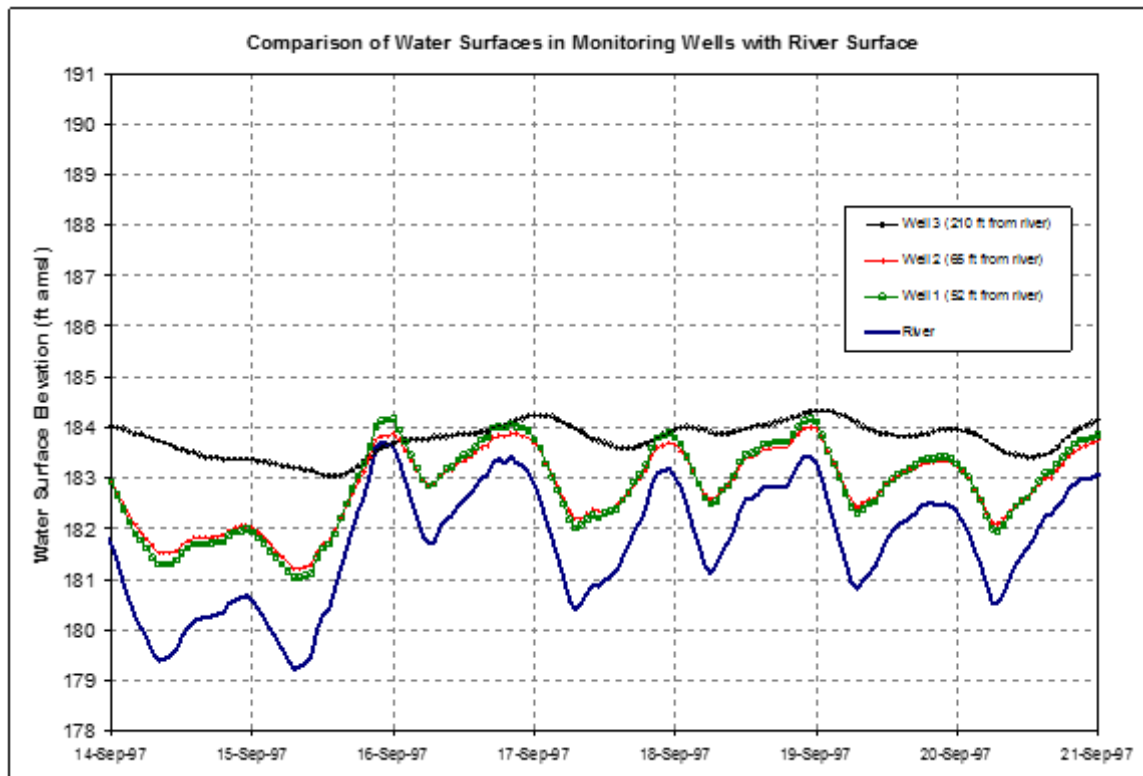
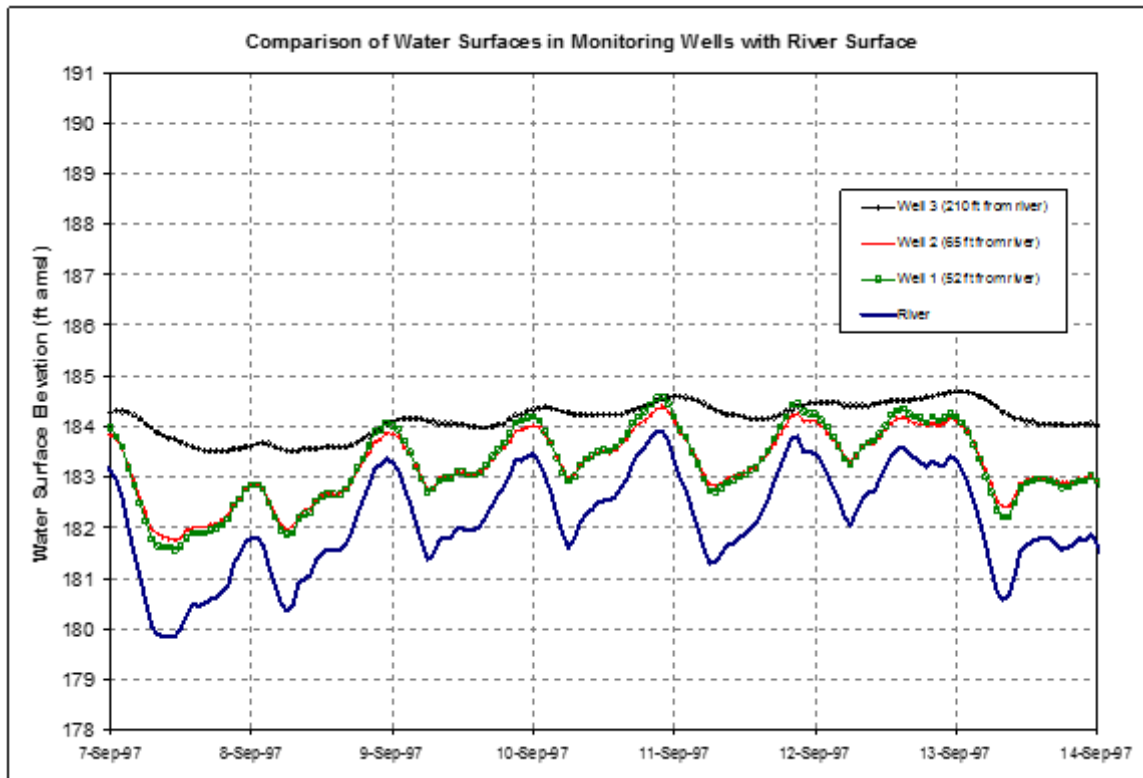
Northfield Mountain Pumped Storage Project (No. 2485) and Turners Falls Hydroelectric Project (No. 1889)  
STUDY 3.1.2 NORTHFIELD MOUNTAIN / TURNERS FALLS OPERATIONS IMPACTS ON EXISTING  
EROSION AND POTENTIAL BANK INSTABILITY



Northfield Mountain Pumped Storage Project (No. 2485) and Turners Falls Hydroelectric Project (No. 1889)  
STUDY 3.1.2 NORTHFIELD MOUNTAIN / TURNERS FALLS OPERATIONS IMPACTS ON EXISTING  
EROSION AND POTENTIAL BANK INSTABILITY

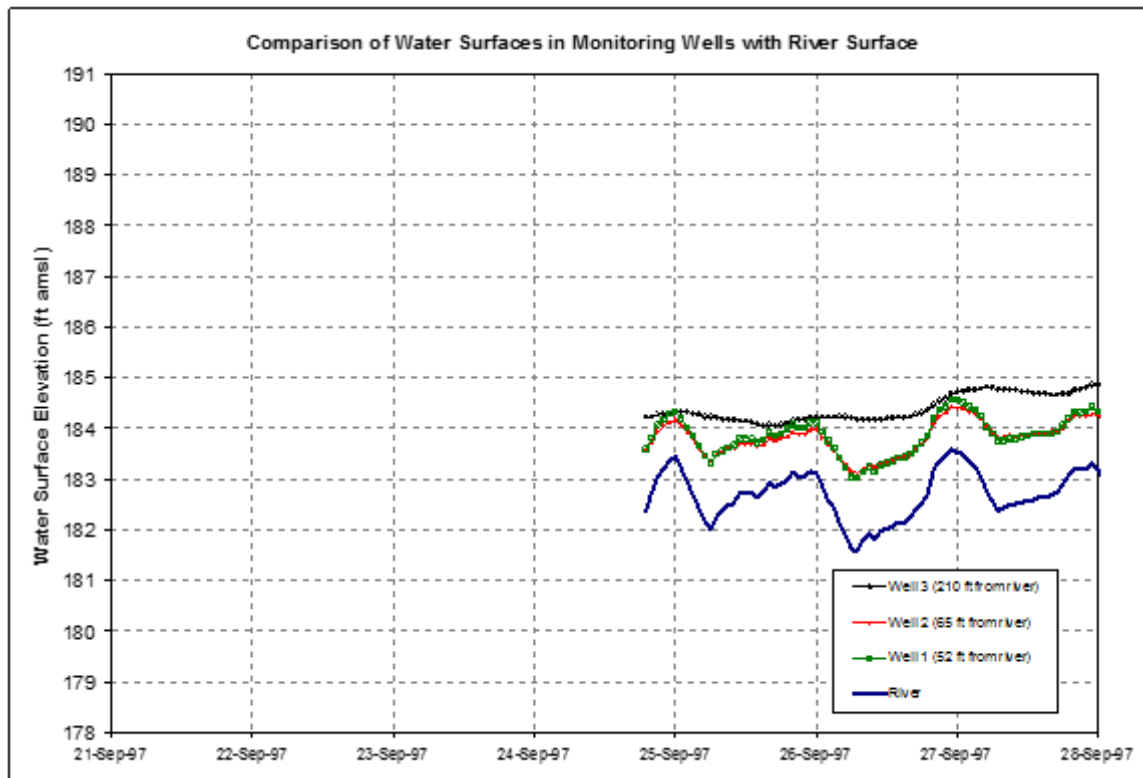
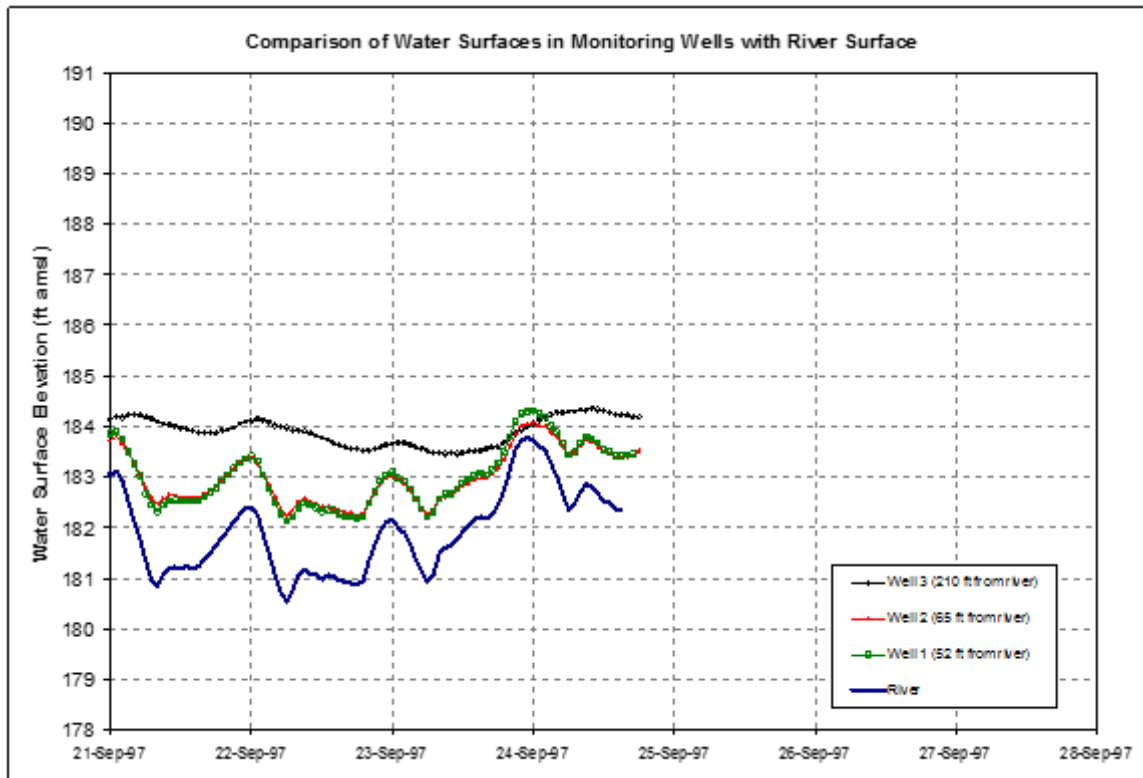


Northfield Mountain Pumped Storage Project (No. 2485) and Turners Falls Hydroelectric Project (No. 1889)  
STUDY 3.1.2 NORTHFIELD MOUNTAIN / TURNERS FALLS OPERATIONS IMPACTS ON EXISTING  
EROSION AND POTENTIAL BANK INSTABILITY

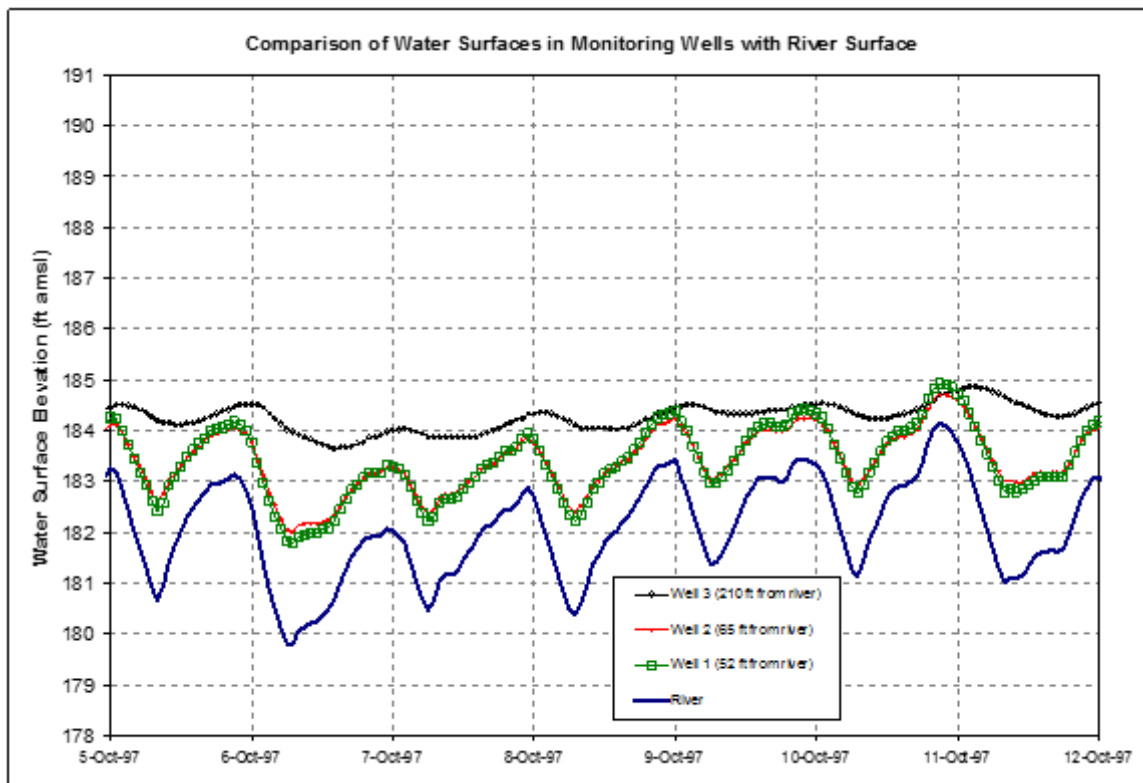
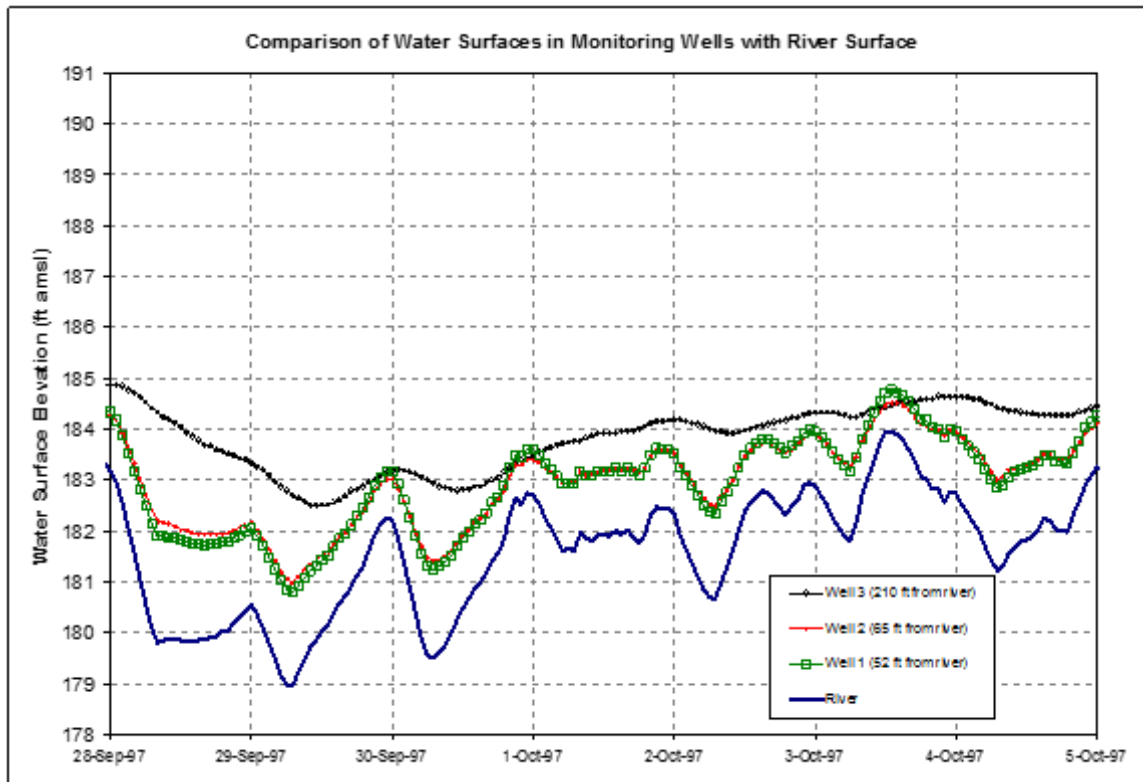




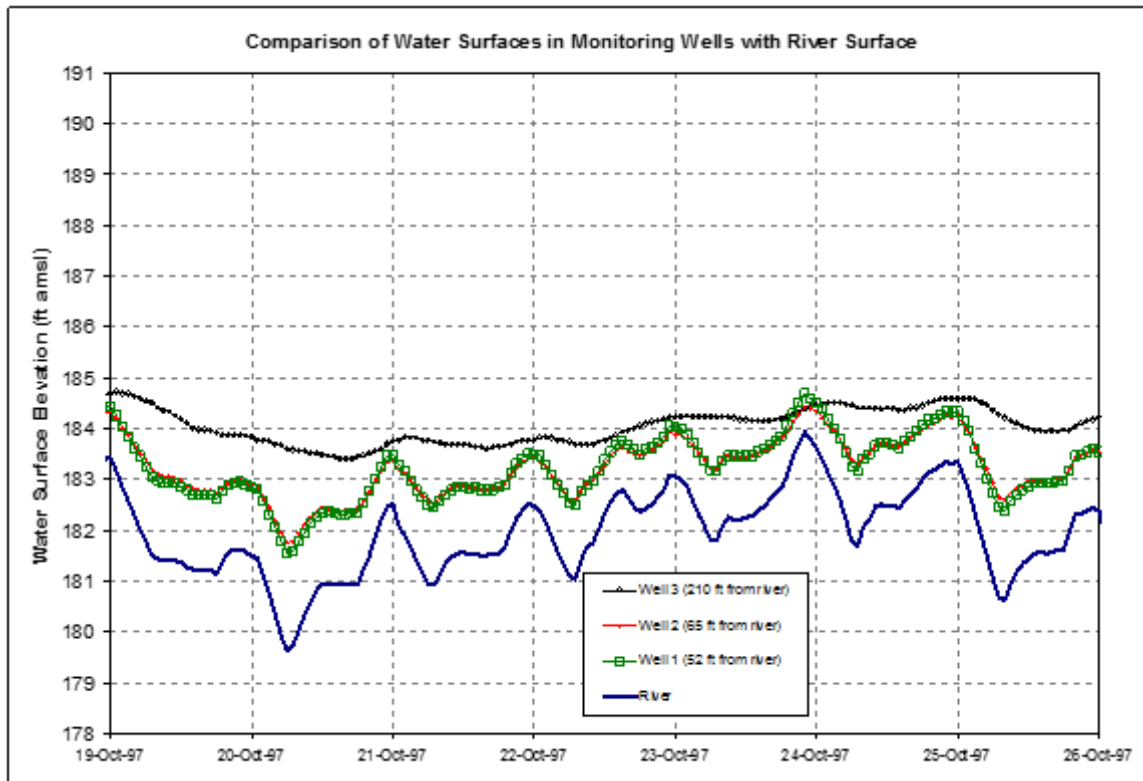
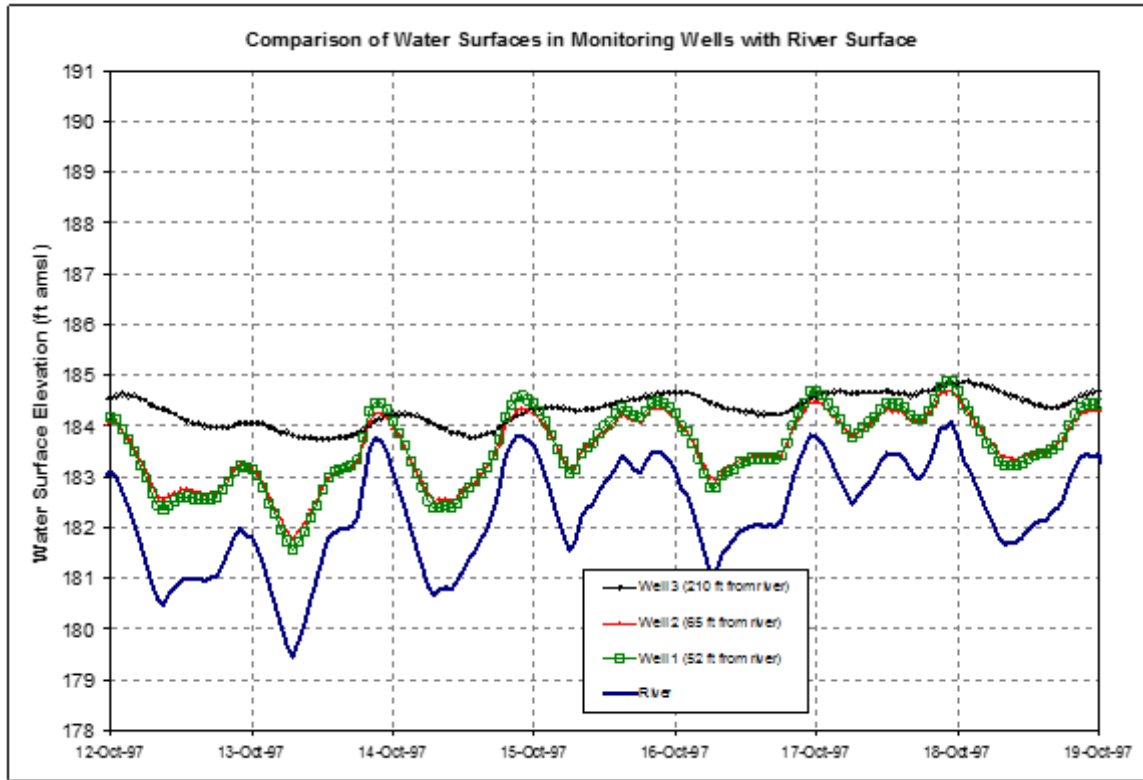
Northfield Mountain Pumped Storage Project (No. 2485) and Turners Falls Hydroelectric Project (No. 1889)  
STUDY 3.1.2 NORTHFIELD MOUNTAIN / TURNERS FALLS OPERATIONS IMPACTS ON EXISTING  
EROSION AND POTENTIAL BANK INSTABILITY



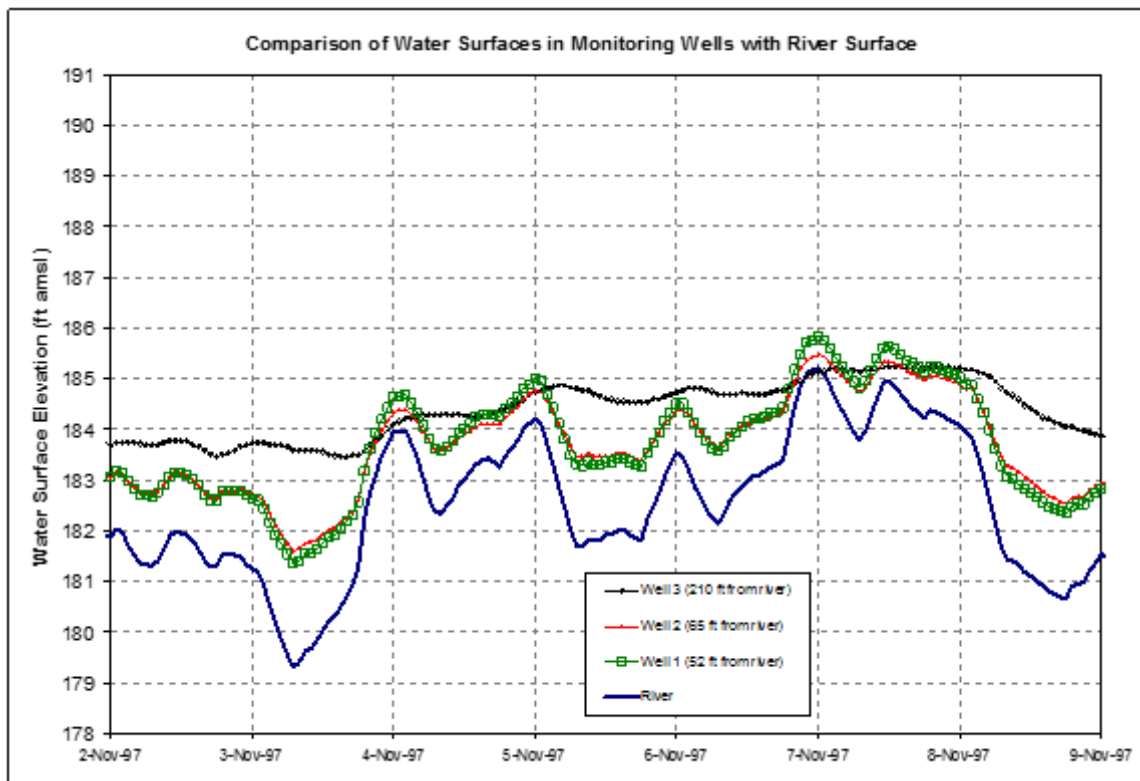
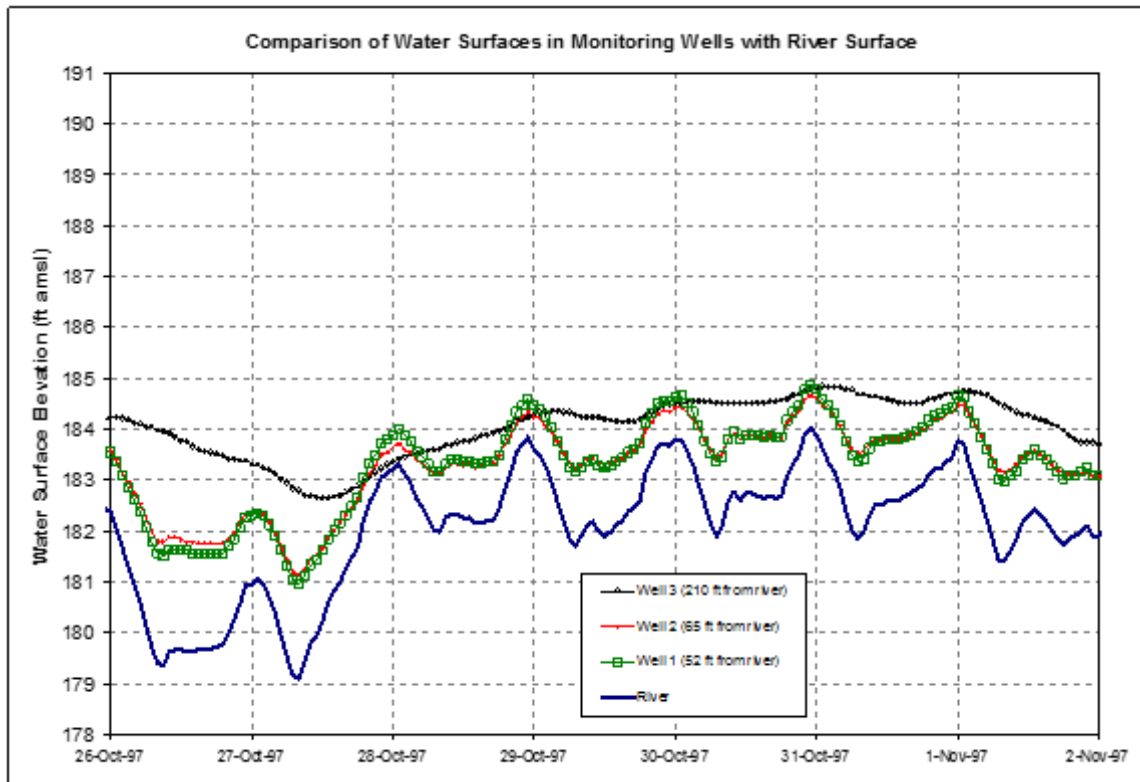
Northfield Mountain Pumped Storage Project (No. 2485) and Turners Falls Hydroelectric Project (No. 1889)  
STUDY 3.1.2 NORTHFIELD MOUNTAIN / TURNERS FALLS OPERATIONS IMPACTS ON EXISTING  
EROSION AND POTENTIAL BANK INSTABILITY



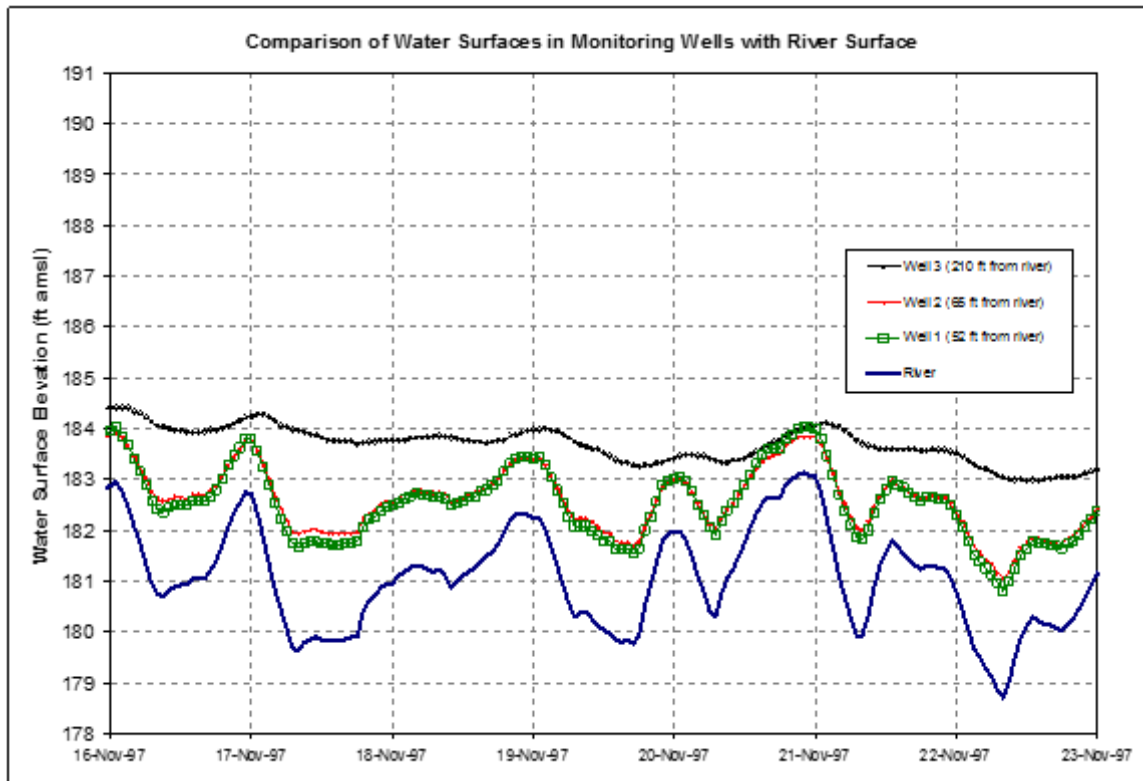
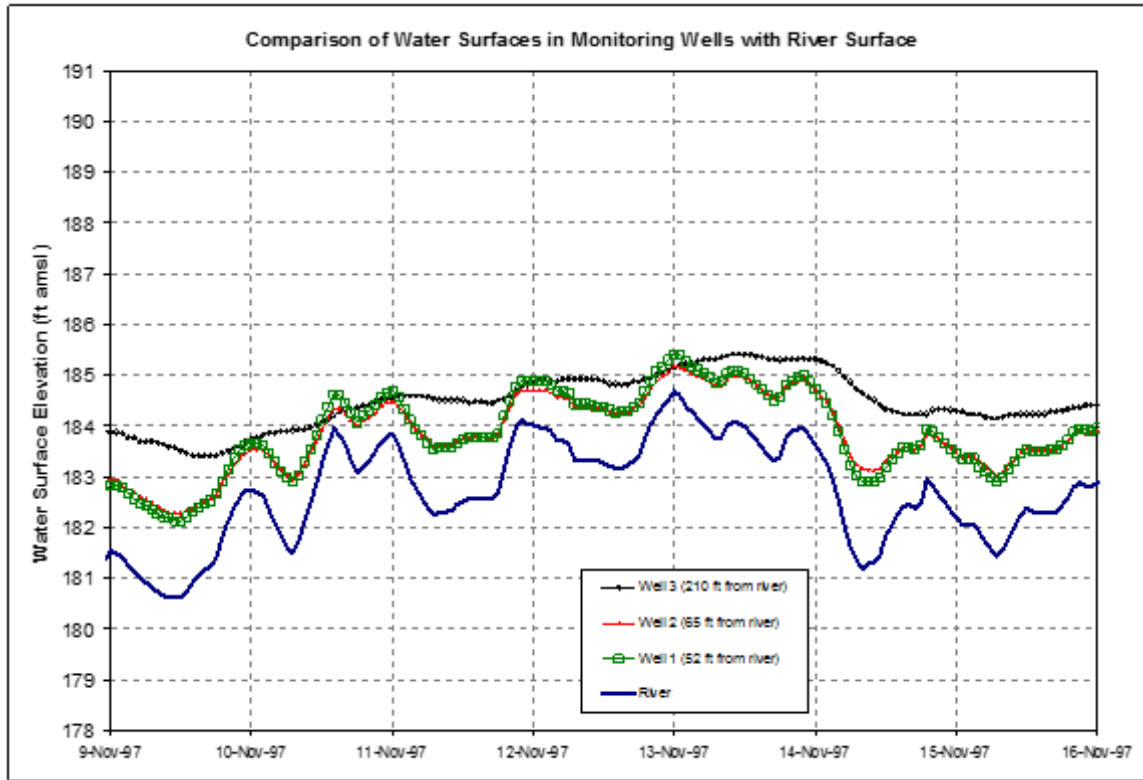
Northfield Mountain Pumped Storage Project (No. 2485) and Turners Falls Hydroelectric Project (No. 1889)  
STUDY 3.1.2 NORTHFIELD MOUNTAIN / TURNERS FALLS OPERATIONS IMPACTS ON EXISTING  
EROSION AND POTENTIAL BANK INSTABILITY



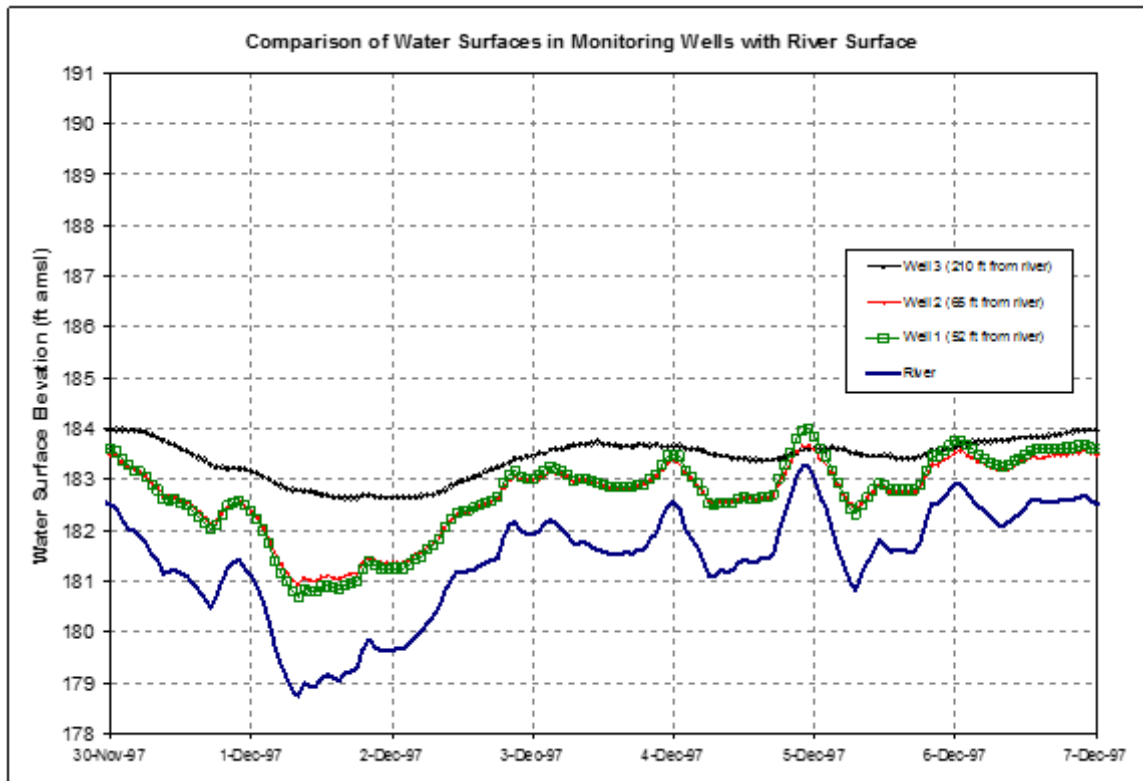
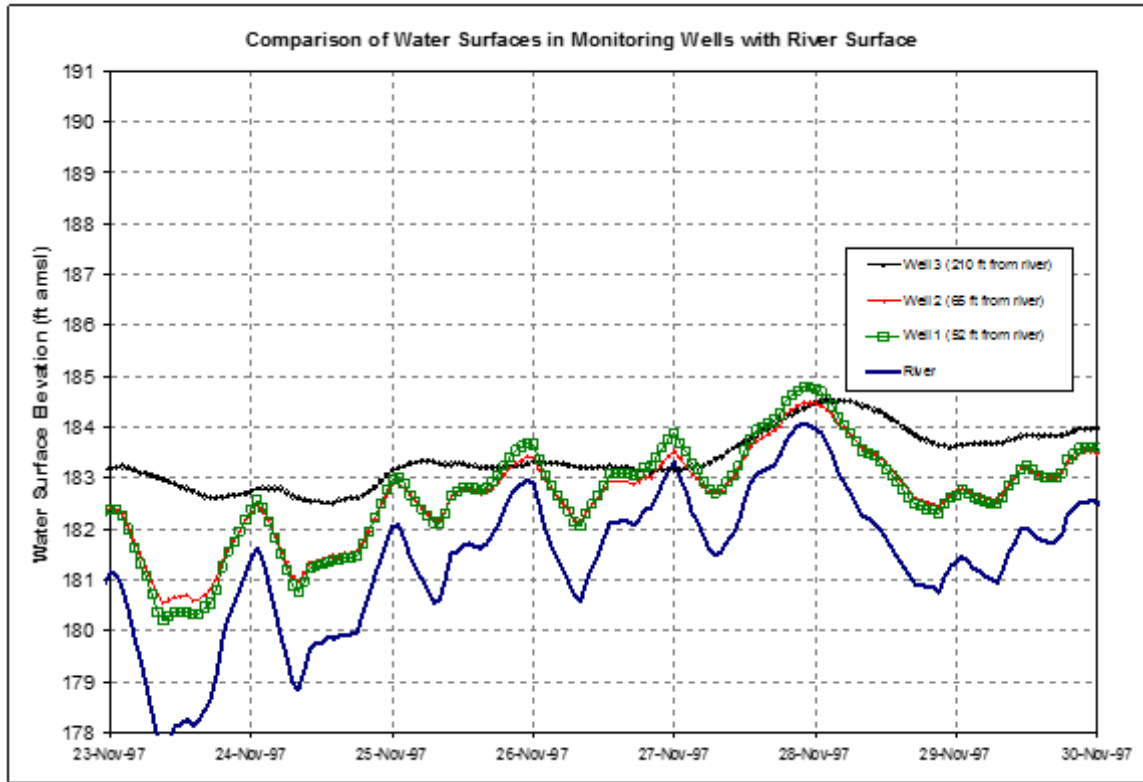
Northfield Mountain Pumped Storage Project (No. 2485) and Turners Falls Hydroelectric Project (No. 1889)  
STUDY 3.1.2 NORTHFIELD MOUNTAIN / TURNERS FALLS OPERATIONS IMPACTS ON EXISTING  
EROSION AND POTENTIAL BANK INSTABILITY



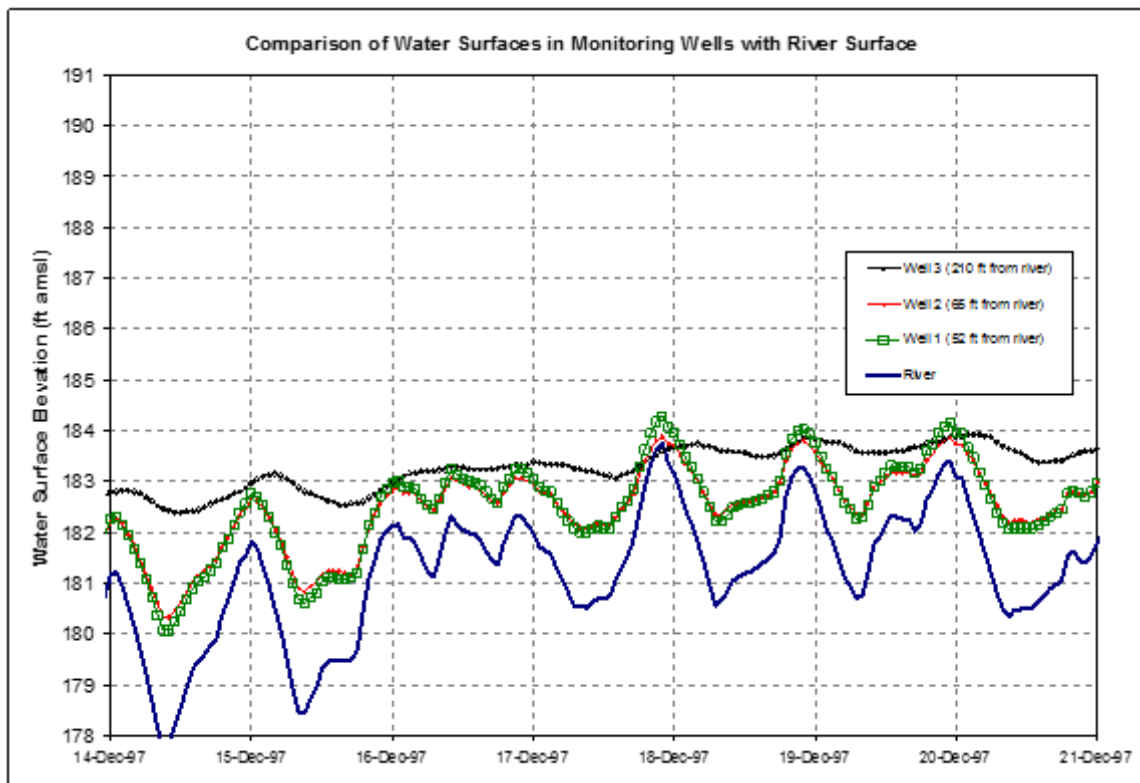
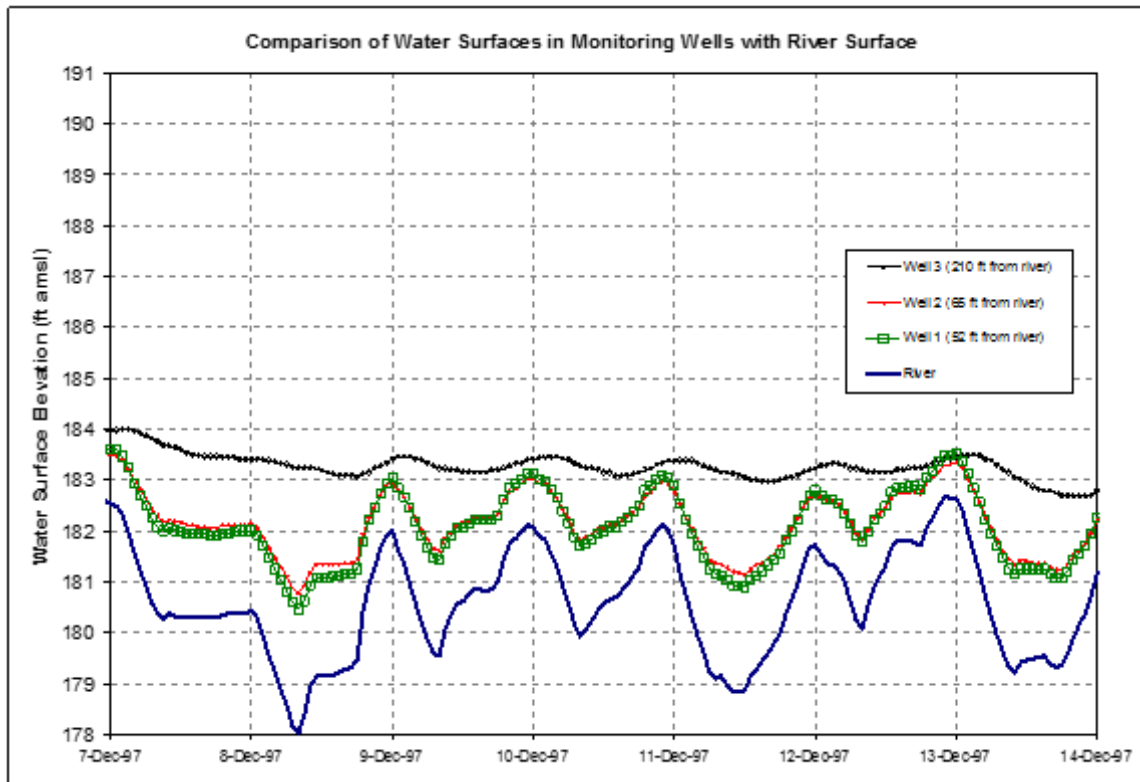
Northfield Mountain Pumped Storage Project (No. 2485) and Turners Falls Hydroelectric Project (No. 1889)  
STUDY 3.1.2 NORTHFIELD MOUNTAIN / TURNERS FALLS OPERATIONS IMPACTS ON EXISTING  
EROSION AND POTENTIAL BANK INSTABILITY



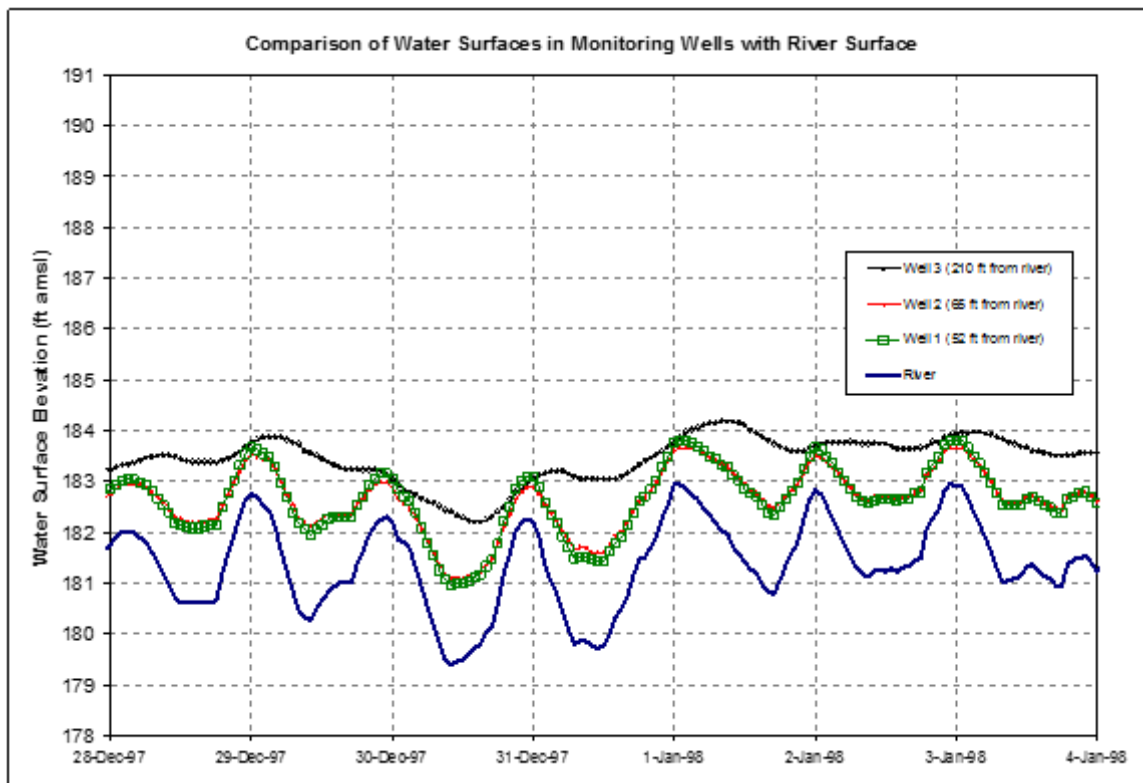
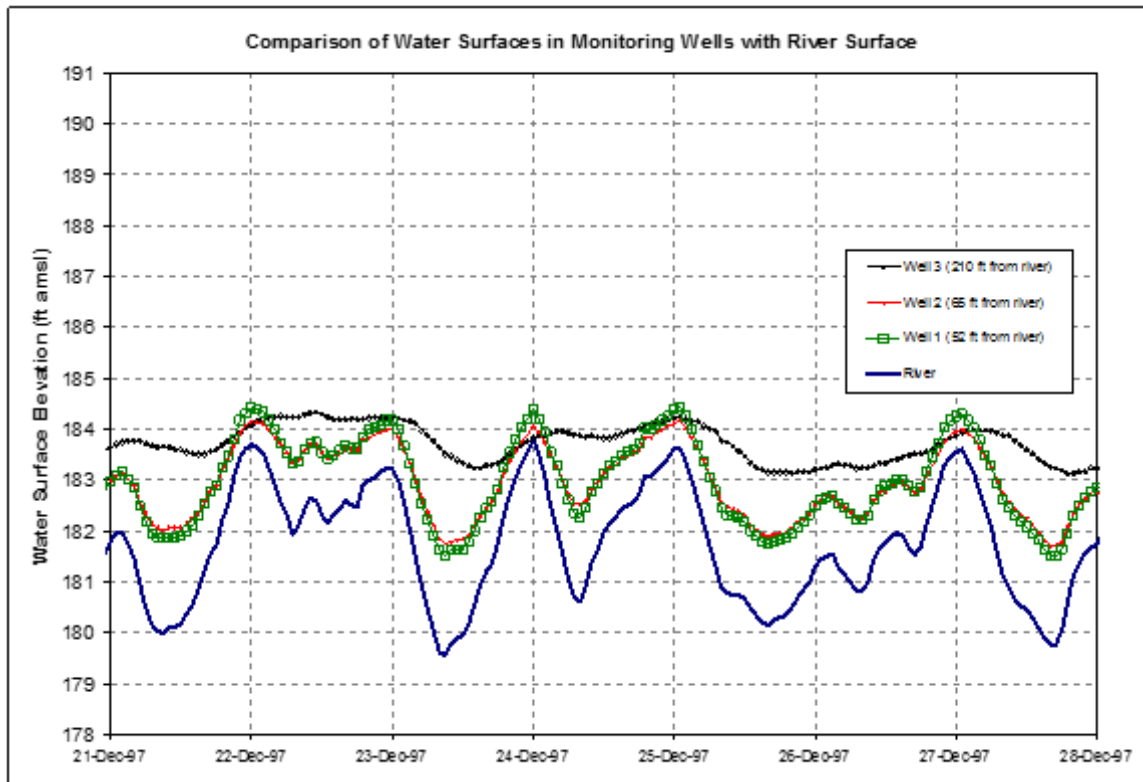
Northfield Mountain Pumped Storage Project (No. 2485) and Turners Falls Hydroelectric Project (No. 1889)  
STUDY 3.1.2 NORTHFIELD MOUNTAIN / TURNERS FALLS OPERATIONS IMPACTS ON EXISTING  
EROSION AND POTENTIAL BANK INSTABILITY



Northfield Mountain Pumped Storage Project (No. 2485) and Turners Falls Hydroelectric Project (No. 1889)  
STUDY 3.1.2 NORTHFIELD MOUNTAIN / TURNERS FALLS OPERATIONS IMPACTS ON EXISTING  
EROSION AND POTENTIAL BANK INSTABILITY

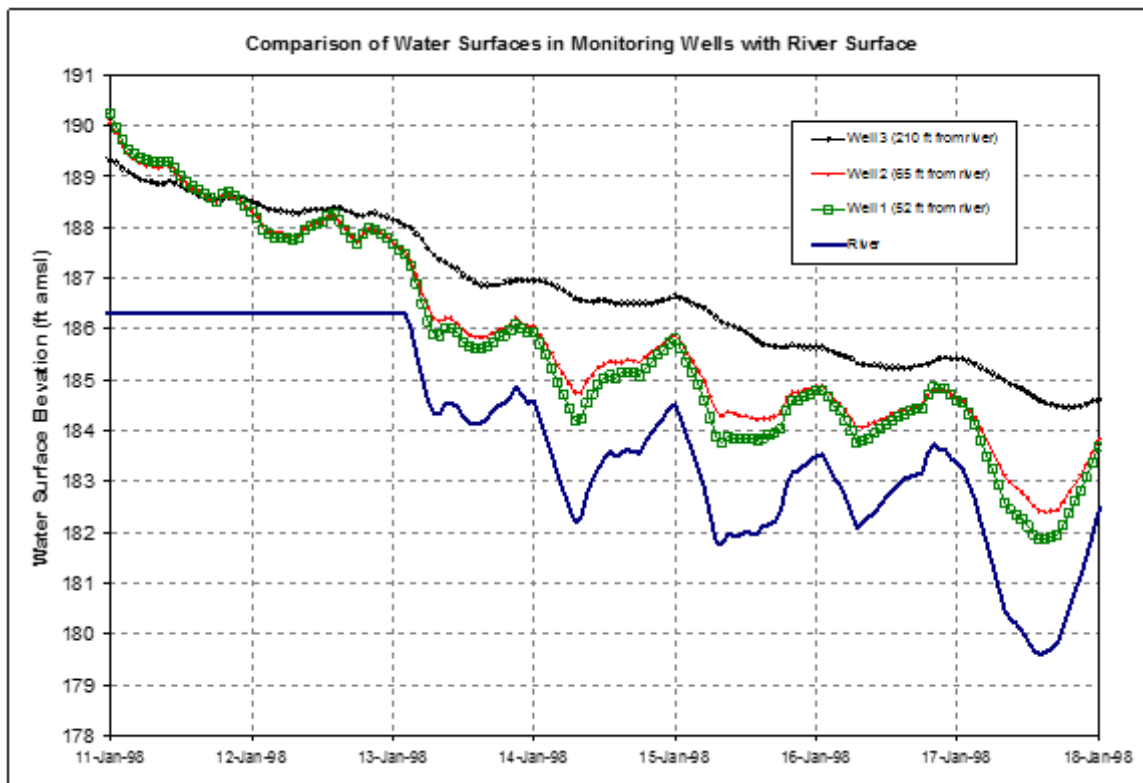
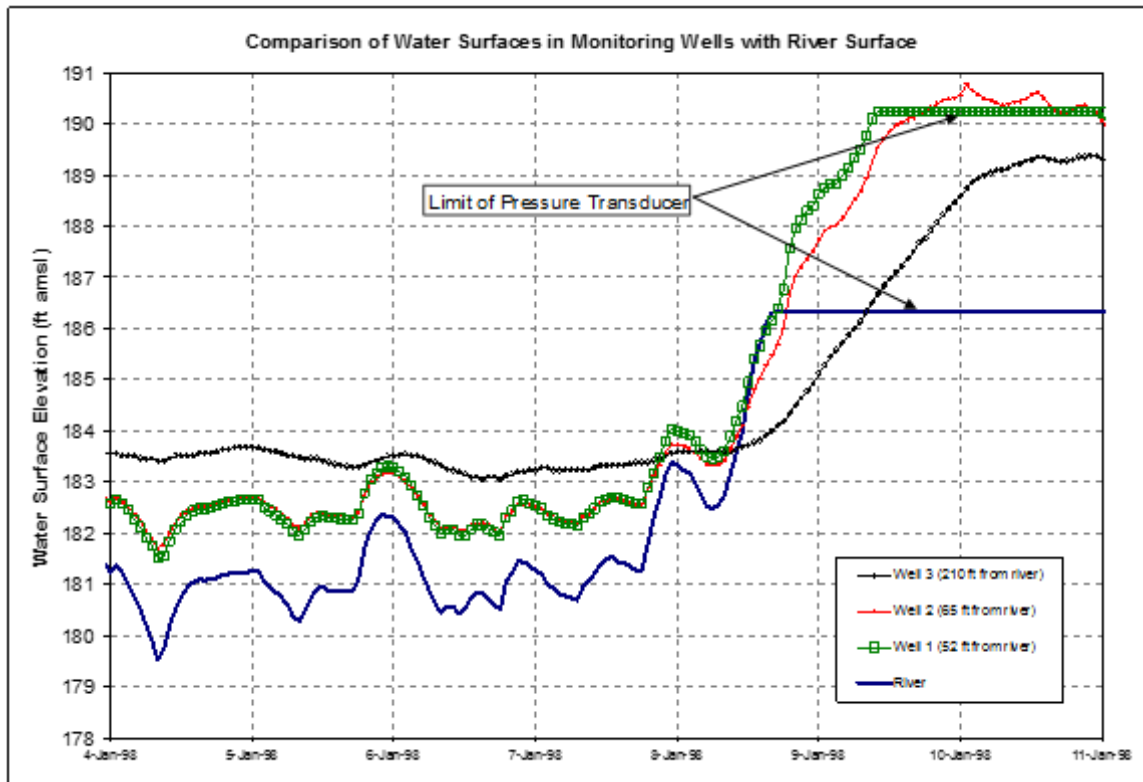


Northfield Mountain Pumped Storage Project (No. 2485) and Turners Falls Hydroelectric Project (No. 1889)  
STUDY 3.1.2 NORTHFIELD MOUNTAIN / TURNERS FALLS OPERATIONS IMPACTS ON EXISTING  
EROSION AND POTENTIAL BANK INSTABILITY

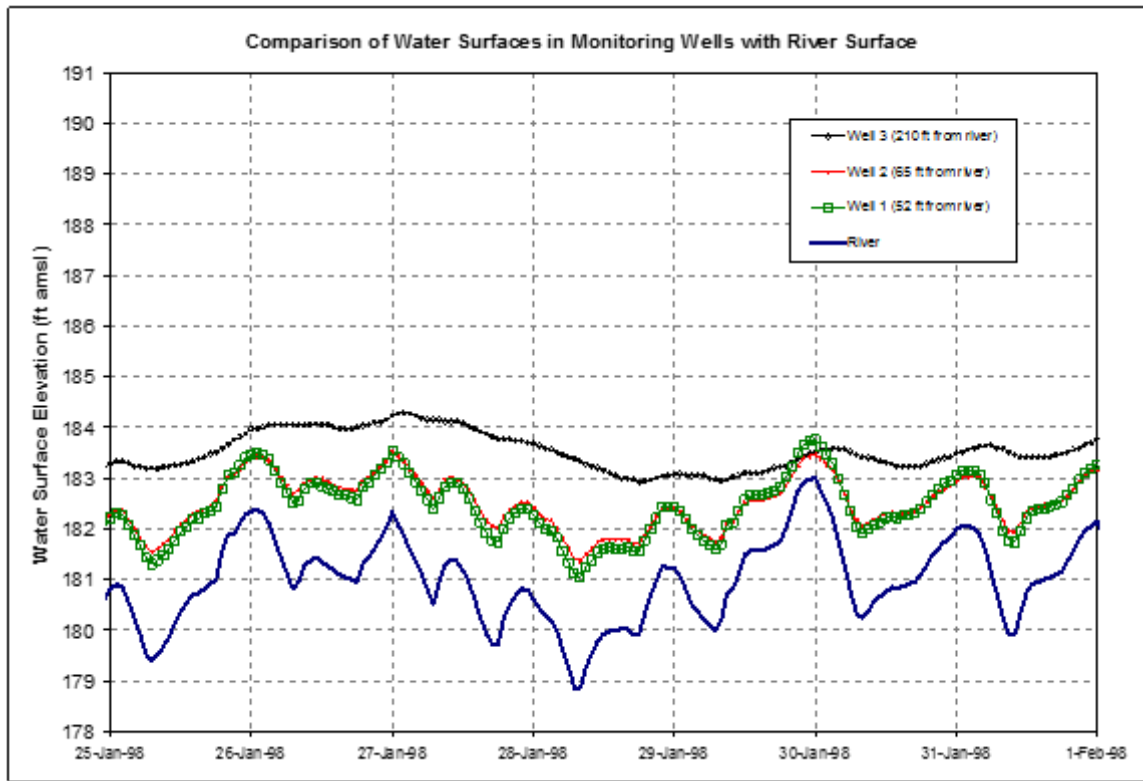
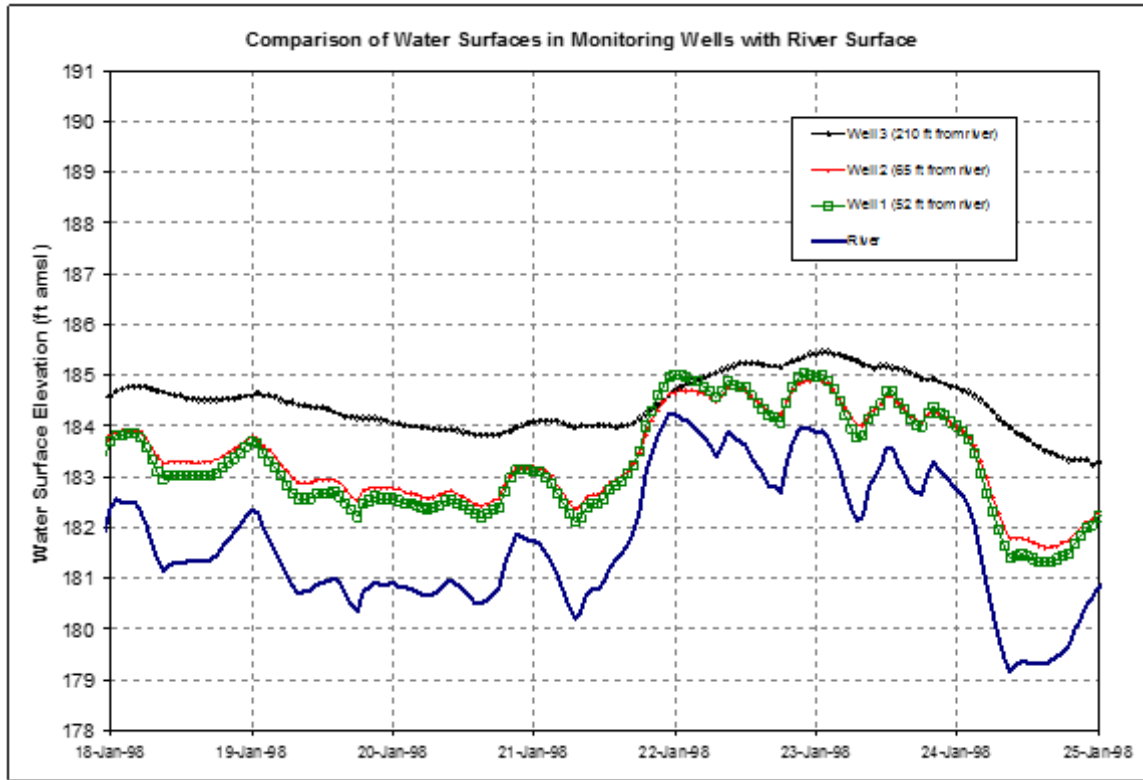




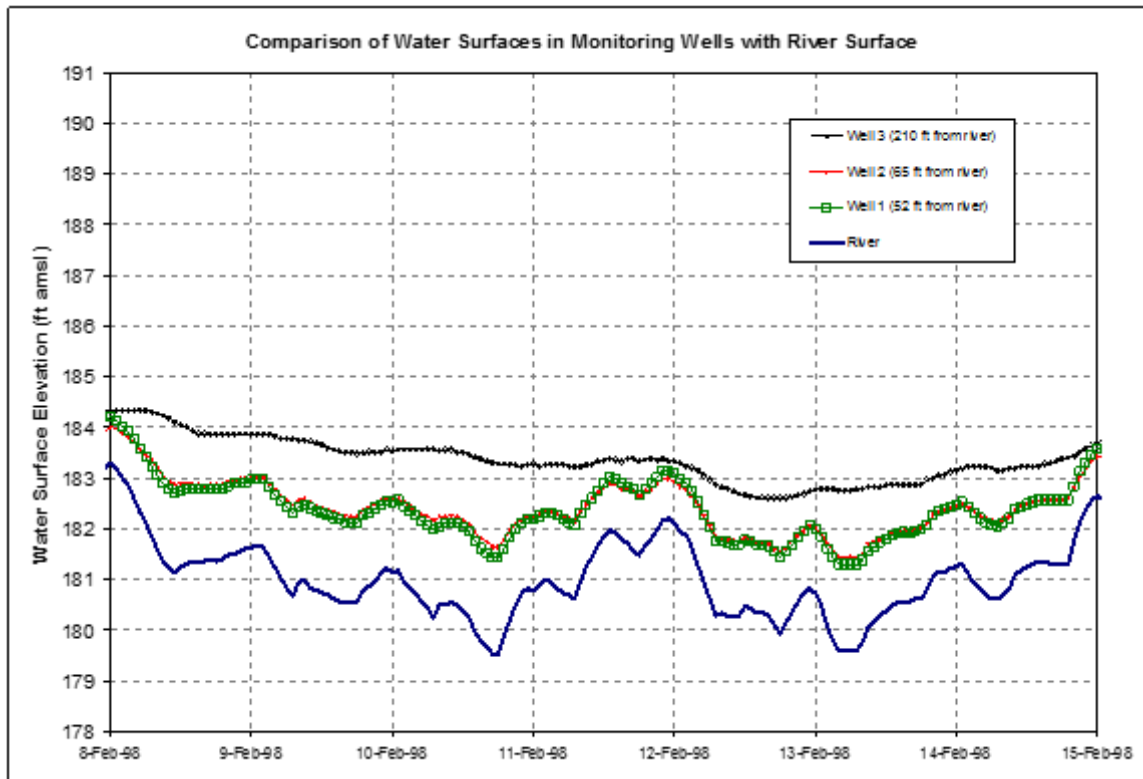
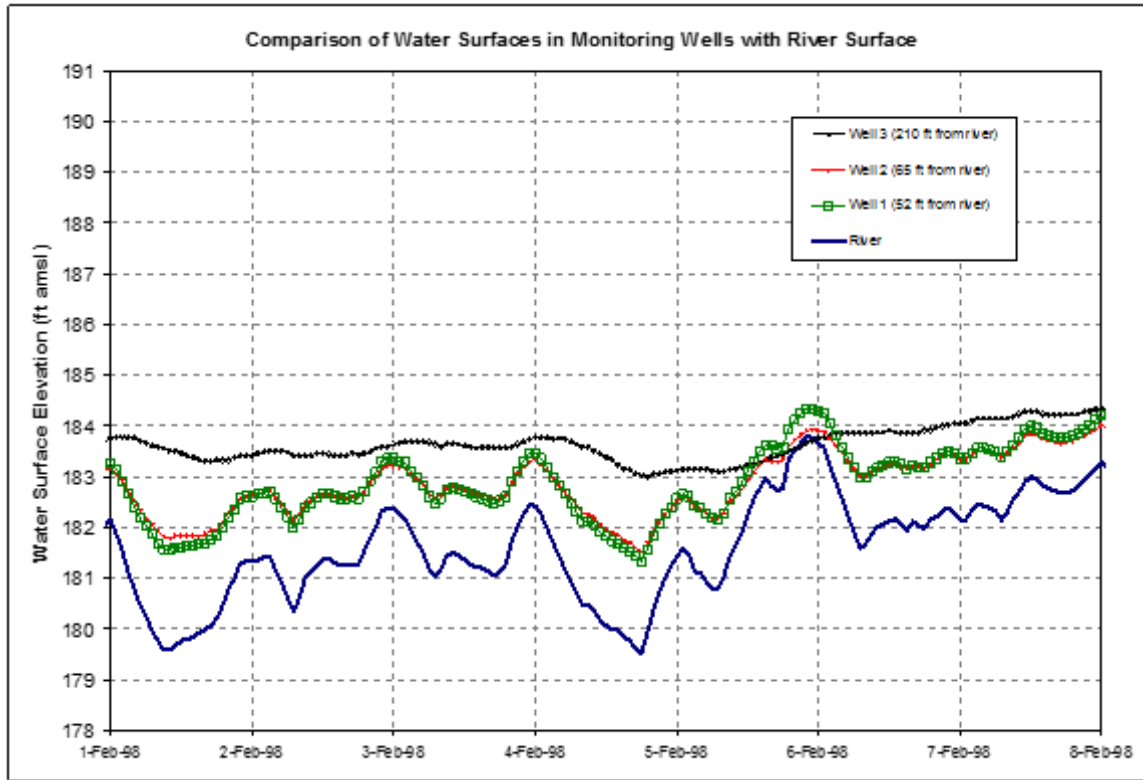
Northfield Mountain Pumped Storage Project (No. 2485) and Turners Falls Hydroelectric Project (No. 1889)  
STUDY 3.1.2 NORTHFIELD MOUNTAIN / TURNERS FALLS OPERATIONS IMPACTS ON EXISTING  
EROSION AND POTENTIAL BANK INSTABILITY



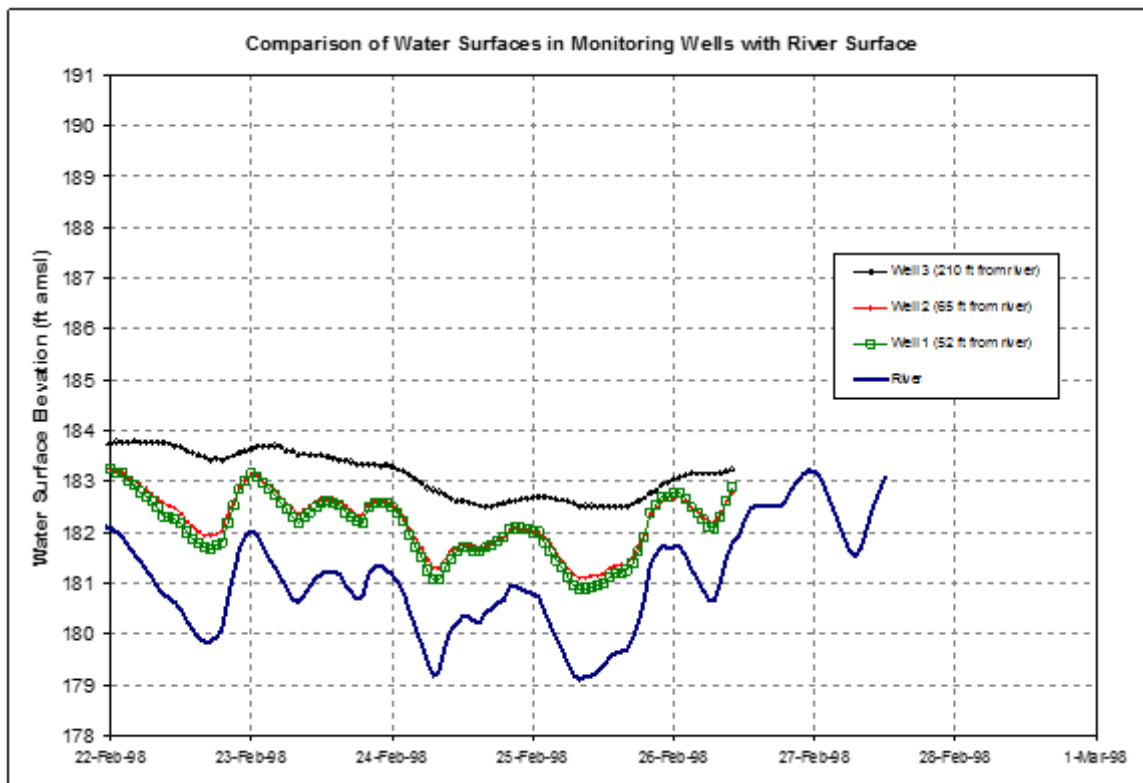
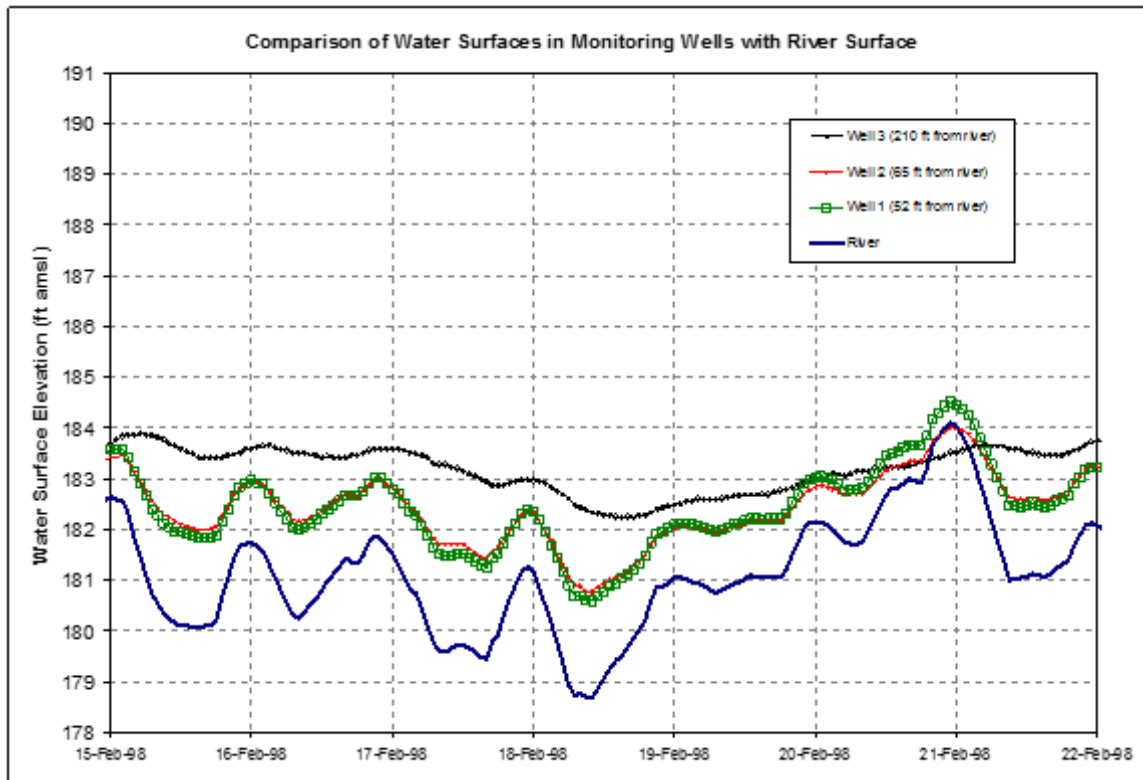
Northfield Mountain Pumped Storage Project (No. 2485) and Turners Falls Hydroelectric Project (No. 1889)  
STUDY 3.1.2 NORTHFIELD MOUNTAIN / TURNERS FALLS OPERATIONS IMPACTS ON EXISTING  
EROSION AND POTENTIAL BANK INSTABILITY



Northfield Mountain Pumped Storage Project (No. 2485) and Turners Falls Hydroelectric Project (No. 1889)  
STUDY 3.1.2 NORTHFIELD MOUNTAIN / TURNERS FALLS OPERATIONS IMPACTS ON EXISTING  
EROSION AND POTENTIAL BANK INSTABILITY



Northfield Mountain Pumped Storage Project (No. 2485) and Turners Falls Hydroelectric Project (No. 1889)  
STUDY 3.1.2 NORTHFIELD MOUNTAIN / TURNERS FALLS OPERATIONS IMPACTS ON EXISTING  
EROSION AND POTENTIAL BANK INSTABILITY



# **APPENDIX J – ICE DATA AND SUPPLEMENTAL INFORMATION**

## **APPENDIX J-1: TEMPERATURE DATA**

Temperature data recorded at the Vernon, VT (1893-1998); Keene, NH (1893-2016); Hanover, NH (1884-2016); and Amherst, MA (1893-2016) monitoring stations is available upon request.

**APPENDIX J-2: ICE MONITORING PHOTOGRAPHS – WINTER 2014/2015 AND 2015/2016**

NOTE: Pictures taken before 12/15/2015 are numbered. Vantage points vary throughout the time pictures were taken prior to 12/15/2015. Pictures taken between 12/15/2015 and 3/8/2016 have consistent vantage points assigned with letters. Each letter indicates a vantage point that remains the same throughout time (i.e., picture A at Pauchaug Boat Launch on 12/15/2015 is the same location as picture A at Pauchaug Boat Launch on 1/5/2016).

See Appendix J-II.pdf

**APPENDIX J-3: LIST OF SCANNED DOCUMENTS FROM TRANSCANADA**

TransCanada allowed access to review and scan files with ice information. The following list of individual file names and content are listed below:

20160229105422918.pdf Vernon Dam 11/4/1927 High Water Book #55  
20160229105505732.pdf Vernon Dam  
20160229105927758.pdf Vernon Dam 11/6/1927  
20160229110117022.pdf Vernon Dam 11/7/1927  
20160229110207358.pdf Vernon Dam 11/5/1927 RR Line Erosion N Walpole  
20160229110316112.pdf N Walpole Flood and Erosion 11/5/1927  
20160229111104563.pdf Conn R High Water Book #123-Ice by Liscomb Brook 1/35  
20160229111231911.pdf Erosion 11/23/1936 Bellows Falls (BF)  
20160229111353344.pdf 1936-1939 Incl TFI and Bridges  
20160229111511775.pdf 1938-1940 82000 CFS TFI  
20160229111608606.pdf 1940 93000 and N Field  
20160229111653870.pdf TFI High Q 1940  
20160229111835664.pdf TFI 1939  
20160229112100264.pdf Conn R Book 158-Survey Pole 1927 and 1936 Flood Heights, Walpole  
20160229112224526.pdf Ice Photos 1942  
20160229112323926.pdf 3/1942 Ice  
20160229112410508.pdf 4/23/1942 Erosion Photos  
20160229112453674.pdf 3 and 4/1942 Ice-Erosion  
20160229112730250.pdf 1942 and 1943 Photos-Erosion ER  
20160229112856407.pdf March-June 1943 Ice and Erosion  
20160229113021786.pdf 1939-1945 Some Ice, Erosion  
20160229113123090.pdf 1945-1946 Ice, Flooding, Erosion



*Northfield Mountain Pumped Storage Project (No. 2485) and Turners Falls Hydroelectric Project (No. 1889)*  
STUDY 3.1.2 NORTHFIELD MOUNTAIN / TURNERS FALLS OPERATIONS IMPACTS ON EXISTING  
EROSION AND POTENTIAL BANK INSTABILITY

---

20160229113316675.pdf 1946 and 1947 Erosion

20160229113509995.pdf Book #299, Erosion

20160229113709288.pdf 1862 or 1869 Flood-Motes, Photos of places where houses washed away

20160229113838470.pdf 3/30/1913 RR Washout

20160229113921716.pdf 3/30/1913 RR Washout

20160229114041975.pdf 1915 Erosion-Farm D/S Vernon Dam, Ice 1915, Stockwell Farm

20160229114148231.pdf 3/3/1915 Ice, East Putney

20160229114235249.pdf Feb/March 1915 Ice, Putney, Demerston Ferry

20160229114325357.pdf 3/1-8/1915 Ice, Suspension Bridge, Matthews Barn

20160229114408623.pdf 2/28-3/1/1915 Ice, Matthews, Crowell Pumping Station

20160229114454627.pdf 2/28/1915 Ice, Asylum Meadow, West River

20160229114632538.pdf 2/28/1915 Ice, Brattleboro Damage to structures

20160229114721709.pdf 2/27-28/1915 Ice Brattleboro

20160229115611024.pdf 1968 Ice Report B.F. Pond

20160229115748717.pdf Bank Erosion and Ice

20160229115839407.pdf Ice in Vermont

20160229115917288.pdf Ice Herricks Cove

20160229120050575.pdf Ice N. of Steamtown, Bank swamping

20160229120122222.pdf Ice-Bank Erosion Walpole

20160229120203566.pdf Ice on Road, BF Dam

20160229120316434.pdf Ice-Vidal Blais-Ice scoured bank 3/25/1968 Cray Property

20160229120348824.pdf Eroded banks showing ice 3/25/1968

20160229120431556.pdf Herricks Cove

20160229120549324.pdf Ice on field, evacuated house, Charlestown

20160229120640894.pdf Steamtown area showing bank erosion and ice

20160229120723335.pdf Bank erosion and ice, helicopter photos, route 12

*Northfield Mountain Pumped Storage Project (No. 2485) and Turners Falls Hydroelectric Project (No. 1889)*  
STUDY 3.1.2 NORTHFIELD MOUNTAIN / TURNERS FALLS OPERATIONS IMPACTS ON EXISTING  
EROSION AND POTENTIAL BANK INSTABILITY

---

20160229120803427.pdf Ice Vermont Yankee Area, Vernon Dam

20160229132225565.pdf Conn River Book #194 – 4/30/1946 Erosion BF U/S

20160229132320504.pdf 1946 and 1951 Ice ETC Windsor BR

20160229132432247.pdf 1946 and 1953 Ice ETC, White R, Windsor BR

20160229132544854.pdf 1953 Ice Springfield VT, W Chesterfield NH

20160229132750945.pdf 4/5/1959 Ice, Charlestown Ice and Erosion

20160229133453106.pdf Spring 1946 High water and Ice

20160229133605262.pdf Spring 1946 Notes on back of photos, Windsor VT, Cornish NH

20160229134036389.pdf April 23-25, 1946, Bank Erosion, Ice damage/erosion

20160229134158989.pdf April 23-25, 1946 Windsor VT, Ice damage/erosion

20160229134304093.pdf April 23-25, 1946 Cornish NH, Ice damage/erosion

20160229134506890.pdf April 23-25, 1946 Cornish NH, Ice damage/erosion

20160229134613415.pdf April 23-25, 1946 Cornish NH, Ice damage/erosion

20160229134736191.pdf April 23-25, 1946 Cornish NH, Ice damage/erosion

20160229134907087.pdf April 23-25, 1946 Cornish NH, Ice damage/erosion

20160229135039552.pdf April 23-25, 1946 Cornish NH, Ice damage/erosion

20160229135852059.pdf Conn River Ice- Field notes 3/8-10/1946

20160229140908456.pdf 1953 Ice Survey Conn and White Rivers- Back to 1944

20160229141440062.pdf 1958 Ice Survey Conn and White Rivers

20160229141615516.pdf 1948 Ice Survey Conn and White Rivers

20160229142407267.pdf River conditions BF Conn River Wilder Jan 8-10, 1930

20160229142407267.pdf River conditions

20160229142647863.pdf Ice info Conn River Jan 14, 15, 16, 1930 Temp data

20160229143707434.pdf Ice conditions February 21-26, 1930

20160229143917288.pdf Flow and weather February 19-March 1, 1930

20160229143957313.pdf Flow and weather February 19-March 1, 1930

*Northfield Mountain Pumped Storage Project (No. 2485) and Turners Falls Hydroelectric Project (No. 1889)*  
STUDY 3.1.2 NORTHFIELD MOUNTAIN / TURNERS FALLS OPERATIONS IMPACTS ON EXISTING  
EROSION AND POTENTIAL BANK INSTABILITY

---

20160229144939157.pdf Ice measurements January 30, 1945

20160229145016656.pdf Ice survey-Wells R to Wilder VT 1944, 1945- Graph

20160229145304468.pdf January 4, 1945 Newspaper article re: Ice and Thaw

20160229145458618.pdf River conditions, spring breakup March 17-25, 1945

20160229145809207.pdf 1945 Ice survey

20160229150123205.pdf River conditions, spring breakup March 17-25, 1945

20160229152242735.pdf Observations of March 1943 with photos

20160229154835640.pdf 1940 Ice survey Wells R – White R

20160229154916139.pdf Ice measurements February 8-10, 1944

20160229154958592.pdf Ice measurements February 8-10, 1944

20160229155138255.pdf Ice measurements February 8-10, 1944 and March 14-17, 1944

20160229155232683.pdf Ice measurements February 8-10, 1944 and March 14-17, 1944

20160229155353684.pdf Spring breakup OBS 1944

20160229155518213.pdf Spring breakup OBS 1944

20160301073455703.pdf Trail Tampering Article re: 1936 and 1938 Flood damage and flies

20160301074145590.pdf 1940 Ice jam- maps and photos

20160301074906643.pdf 1940 Log of OBS

20160301075055202.pdf River conditions u/s Whiter April 13, 1940

20160301075533461.pdf Summary Inspection of Ice spring 1940

20160301080134738.pdf Ice jams at Waterford April 10, 1941-maps and photos

20160301080946446.pdf Field notes, March 1946

20160301081323525.pdf Ice conditions January 7-12, 1946

20160301081658914.pdf 1946 Ice survey Wells R to Windsor VT

20160301081931315.pdf 1946 Ice map

20160301082038899.pdf Ice measurements 1946

20160301083515697.pdf Flood and ice report 1946

*Northfield Mountain Pumped Storage Project (No. 2485) and Turners Falls Hydroelectric Project (No. 1889)*  
STUDY 3.1.2 NORTHFIELD MOUNTAIN / TURNERS FALLS OPERATIONS IMPACTS ON EXISTING  
EROSION AND POTENTIAL BANK INSTABILITY

---

20160301084646101.pdf Notes of 1946 Spring runoff- notes on TFI

20160301084948876.pdf Report of January 1946 river and ice conditions January 7-13, 1946

20160301085402351.pdf Conn River ice March 1946

20160301090012441.pdf 1946 High water and ice March 15-18, 1946

20160301090028260.pdf High water OBS Spring 1946

20160301090625807.pdf 1946 High water OBS

20160301090848758.pdf April 23, 1946 Connect R Inspection Trip-comments on erosion

20160301091151433.pdf Q- USGS March 19, 1946

20160301091326041.pdf Ice map March 18, 1946

20160301091436580.pdf Ice map March 15, 1946

20160301091559541.pdf Newspaper March 11, 1946

20160301091852616.pdf Newspaper March 11, 1946

20160301092027183.pdf Newspaper March 11, 1946

20160301092237336.pdf Erosion photos

20160301092339399.pdf Erosion and ice scar photos

20160301092430587.pdf Erosion and ice scar photos

20160301092602381.pdf Erosion and ice scar photos

20160301092634823.pdf Erosion and ice scar photos April 23, 1946

20160301092727395.pdf Erosion and ice scar photos

20160301092907337.pdf Erosion and ice scar photos

20160301093002604.pdf Erosion and ice scar photos

20160301093052399.pdf Erosion and ice scar photos

20160301093142877.pdf Erosion and ice scar photos

20160301093237044.pdf Erosion and ice scar photos

20160301093324785.pdf Erosion and ice scar photos

20160301093350688.pdf Erosion and ice scar photos

*Northfield Mountain Pumped Storage Project (No. 2485) and Turners Falls Hydroelectric Project (No. 1889)*  
STUDY 3.1.2 NORTHFIELD MOUNTAIN / TURNERS FALLS OPERATIONS IMPACTS ON EXISTING  
EROSION AND POTENTIAL BANK INSTABILITY

---

20160301093433938.pdf Erosion and ice scar photos

20160301094047760.pdf 9/21/1938 Stricken Area

20160301094523267.pdf 9/24/1938 Newspaper-500 dead in flood

20160301094625111.pdf 9/24/1938 Newspaper-500 dead in flood

20160301095550532.pdf Ice breakup exp 1939

20160301095918614.pdf Ice breakup Hold harmless- history of ice jam floods 1936 and more

20160301100549570.pdf Ice breakup News release

20160301100900108.pdf CRREL Ice breakup paper

20160301101457855.pdf EA-Ice breakup-Fonsi

20160301101601499.pdf EA-Ice breakup-Fonsi

20160301102118200.pdf CRREL paper re: Ice breakup (mentions ice breakup 1936)

20160301102828840.pdf CRREL-options for management of dynamic breakup (historic info)

20160301103327188.pdf Ice out Windsor BR 3/16-17/1989 – photos

20160301103442262.pdf Ice exp March 1989 photos

20160301103903920.pdf CRREL ice test field notes March 1989

20160301104426511.pdf “A Study of Dynamic Ice Breakup” 1987

20160301105117632.pdf Bank erosion photos

20160301105402958.pdf Contract docs 1977 for USACE study

20160301110019731.pdf Newspaper article re: Corps erosion study – some discussion of ice

20160301110334857.pdf Newspaper article – some info on tree clearing – Northfield

20160301110630947.pdf Newspaper article on erosion

20160301110746388.pdf News article re: erosion – north field

20160301111854501.pdf Lake Champlain erosion study

20160301112746788.pdf Conn R stream bank erosion study 1947

20160301113043018.pdf Wilder erosion study 1974

20160301113538535.pdf Erosion photos – non impounded reach 1973

*Northfield Mountain Pumped Storage Project (No. 2485) and Turners Falls Hydroelectric Project (No. 1889)*  
STUDY 3.1.2 NORTHFIELD MOUNTAIN / TURNERS FALLS OPERATIONS IMPACTS ON EXISTING  
EROSION AND POTENTIAL BANK INSTABILITY

---

20160301113914177.pdf News article 1975 erosion

20160301115023470.pdf Report on stream bank erosion, Corps 1969

20160301120636295.pdf Bank erosion study NH, VT – USGS 1974

20160301120828271.pdf Erosion maps (sites on USGS)

20160301120906892.pdf Erosion sites on USGS map

20160301121051972.pdf Erosion sites on USGS map

20160301121228722.pdf Erosion sites on USGS map

20160301121340786.pdf Erosion sites on USGS map

20160301121509906.pdf Erosion sites on USGS map

20160301121538662.pdf Erosion sites on USGS map

20160301121723089.pdf Erosion sites on USGS map

20160301121743901.pdf Erosion sites on USGS map

20160301125827778.pdf 1952 weather snow and ice info

20160301130549449.pdf Ice measurements March 1958

20160301131629028.pdf 1952 Slide/RR

20160301132028550.pdf 1952 Ice survey Conn and White R (goes back to 1946)

20160301132908741.pdf Conn River OBS- Wilder to BF 1952

20160301133334129.pdf 1951 Conn River OBS White R to BF

20160301133801375.pdf 1952 Ice survey

20160301133953805.pdf Conn R high water and ice OBS

20160301134315936.pdf Conn R OBS, BF Basin March 16-18, 1953

20160301134628934.pdf 1953 Ice survey Conn and White R's

20160301134736970.pdf 1953 Ice conditions – upper Wilder Pond

20160301134920483.pdf Bellows Falls Pond ice conditions February 1953

20160301135028753.pdf High water notes January 25-26, 1953 Windsor BF

20160301135146940.pdf Wilder Pond OBS January 26, 1953

*Northfield Mountain Pumped Storage Project (No. 2485) and Turners Falls Hydroelectric Project (No. 1889)*  
STUDY 3.1.2 NORTHFIELD MOUNTAIN / TURNERS FALLS OPERATIONS IMPACTS ON EXISTING  
EROSION AND POTENTIAL BANK INSTABILITY

---

20160301135840581.pdf High water at BF 2/23/1954

20160301140030302.pdf OBS – upper Conn R 6/21/1954

20160301140631602.pdf Upper Conn R ice conditions March 1954

20160301141519889.pdf February 1954 – notes and OBS Conn River

20160301141636662.pdf Conn R OBS March 1954

20160301141912553.pdf 1955 Ice survey Conn and White R

20160301142319573.pdf 1955 Ice survey Conn and White R

20160301142726085.pdf Wilder high water OBS April 1955

20160301143141189.pdf Conn R OBS bank inspection April 1955 (14<sup>th</sup> and 15<sup>th</sup>)

20160301143209911.pdf Conn R OBS 4/7/1955

20160301143307898.pdf Up river ice OBS 03/30/1955

20160301143540795.pdf 1955 Ice survey

20160301143844089.pdf Ice measurements ABV Waterford BR 2/17/1955

20160301143941344.pdf Conn R OBS 3/17/1955

20160301144211271.pdf River OBS notes 1955

20160301145028887.pdf 1956 Ice survey Conn and White R's

20160301145203823.pdf Conn R OBS 4/17/1956

20160301145533825.pdf Bellows Falls and Vernon Spring high water OBS April-May 1956

20160301145717043.pdf White R ice survey 1956

20160301150145370.pdf 1956 Ice survey Conn and White R

20160301150803413.pdf OBS Ice formation, Moore-Wilder Winter 1956-1957

20160301150953277.pdf 1957 Ice survey Conn and White R

20160301151323111.pdf 4/4/1959 Ice photos

20160301151423896.pdf 4/4/1959 Ice photos

20160301151506762.pdf 4/5/1959 Ice photos

20160301151557382.pdf 4/5/1959 Ice photos

*Northfield Mountain Pumped Storage Project (No. 2485) and Turners Falls Hydroelectric Project (No. 1889)*  
STUDY 3.1.2 NORTHFIELD MOUNTAIN / TURNERS FALLS OPERATIONS IMPACTS ON EXISTING  
EROSION AND POTENTIAL BANK INSTABILITY

---

20160301151703222.pdf 4/1/1959 Conn R OBS  
20160301151837647.pdf April 3-7, 1959 Conn R OBS  
20160301152153905.pdf March 31-April 6, 1959 Conn R OBS  
20160301152506664.pdf Newspaper: Ice and water surge 3/12/1992  
20160301152829969.pdf Newspaper: Ice on Deerfield 1/31/1992  
20160301153108445.pdf Newspaper: Ice on Deerfield 1/26/1994  
20160301153309484.pdf Newspaper: Alton Dam BRV 3/15/1996  
20160301154544626.pdf Slope movement problems Windsor City, VT 1984  
20160301154649750.pdf Slope movement problems Windsor City, VT 1984  
20160301155618495.pdf Conn R bank survey  
20160301155659934.pdf Conn R bank survey April 1947 – Desc of erosion  
20160301155738298.pdf Conn R bank survey April 1947 – Desc of erosion  
20160301155826865.pdf Conn R bank survey May-June 1947 – Desc of erosion  
20160301160050193.pdf Conn R bank survey May-June 1947 – Desc of erosion  
20160301160202780.pdf Conn R bank survey May-June 1947 – Desc of erosion  
20160301160610850.pdf BF to White R 1947 Bank erosion survey  
20160301160717676.pdf BF to White R 1947 Bank erosion survey  
20160301160832805.pdf BF to White R 1947 Bank erosion survey  
20160301160933806.pdf BF to White R 1947 Bank erosion survey  
20160301161032841.pdf BF to White R 1947 Bank erosion survey  
20160301161138162.pdf BF to White R 1947 Bank erosion survey  
20160301161238269.pdf BF to White R 1947 Bank erosion survey  
20160301161342125.pdf BF to White R 1947 Bank erosion survey  
20160301161438456.pdf BF to White R 1947 Bank erosion survey



#### **APPENDIX J-4: DOCUMENTATION OF THE ESTABLISHMENT AND GROWTH OF NEW RIPARIAN VEGETATION**

Aerial photographs from 1929 to 1952 showed severely eroded areas in the upper TFI followed by increased riparian vegetation documented in the 2008-2010 aerial images and confirmed by the 1998, 2008 and 2013 FRRs in these same previously eroded areas of the river. The 2008 FRR presented several examples of the natural stabilization process in Appendix F of the 2008 FRR, which included this same location downstream of Vernon Dam as well as a large area of new aquatic vegetation on the lower riverbank at another location. The 2013 FRR discussed the ongoing recruitment of new vegetation on the lower riverbank and presented examples showing the increase in lower riverbank vegetation. A comparison of 2008 to 2013 showed an increase in lower riverbank vegetation from 5.1% in 2008 to 11.7% in 2013 (an increase of approximately 16,000 linear feet).

In previous years, observations of herbaceous and aquatic vegetation on the lower riverbank had been made. During recent visits in 2014 and 2015 for data collection at detailed study sites; observations were made of the fact that seeds, seedlings and saplings of woody vegetation have recently been establishing and growing on the lower riverbank at various locations along the TFI. Woody vegetation that has recently been observed in this establishment and growth phase from seeds, seedlings and saplings include maples and cottonwoods. The establishment of woody vegetation represents a new phase of natural stabilization that includes the type of root structure associated with trees rather than just herbaceous or aquatic vegetation that was observed in the 2008 and 2013 FRRs. The process of the recruitment of woody vegetation indicates that in recent years (2014 and 2015); trees have been recently established and are beginning to grow. Examples of this process and locations are provided.

**Figure J-4.1 Maple seeds (photo 0202, 9/28/2015)**



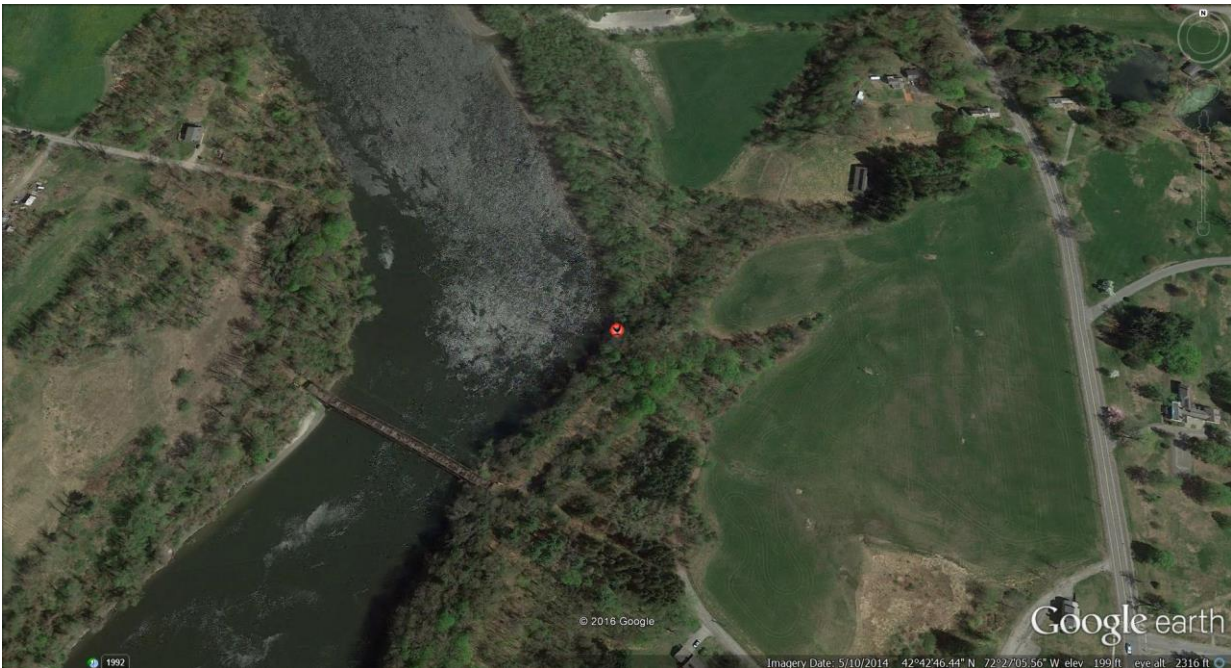
**Figure J-4.2 Location of photo #0202**



**Figure J-4.3 Maple seedlings (photo 0203, 9/28/2015)**



**Figure J-4.4 Location of photo #0203**



**Figure J-4.5 Cottonwood seedlings (photo 0204, 9/28/2015)**



**Figure J-4.6 Location of photo #0204**



**Figure J-4.7 Cottonwood seedlings (photo 0206, 9/28/2015)**



**Figure J-4.8 Location of photo #0206**



**Figure J-4.9 Cottonwood seedlings (photo 6576, 7/15/2014)**



**Figure J-4.10 Location of photo #6576**



**Figure J-4.11 Lower riverbank vegetation (photo 6779, 7/17/2014)**



**Figure J-4.12 Location of photo #6779**



**Figure J-4.13 Lower riverbank vegetation with seedlings (photo 9203, 9/22/2014)**



**Figure J-4.14 Location of photo #9203**





**Figure J-4.15 Maple seedling (photo 9217, 9/22/2014)**



**Figure J-4.16 Location of photo #9217**



**Figure J-4.17 Maple seedling (photo 9218, 9/22/2014)**



**Figure J-4.18 Location of photo #9218**



**Figure J-4.19 Maple sapling (photo 9219, 9/22/2014)**



**Figure J-4.20 Location of photo #9219**



**Figure J-4.21 Lower riverbank vegetation with seedlings (photo 9297, 9/23/2014)**



**Figure J-4.22 Location of photo #9297**



**Figure J-4.23 Cottonwood seedlings (photo 9298, 9/23/2014)**



**Figure J-4.24 Location of photo #9298**



**Figure J-4.25 Cottonwood seedlings (photo 9299, 9/23/2014)**



**Figure J-4.26 Location of photo #9299**



**Figure J-4.27 Maple seedlings (photo 9300, 9/23/2014)**



**Figure J-4.28 Location of photo #9300**



**Figure J-4.29 Maple sapling (photo 9307, 9/23/2014)**



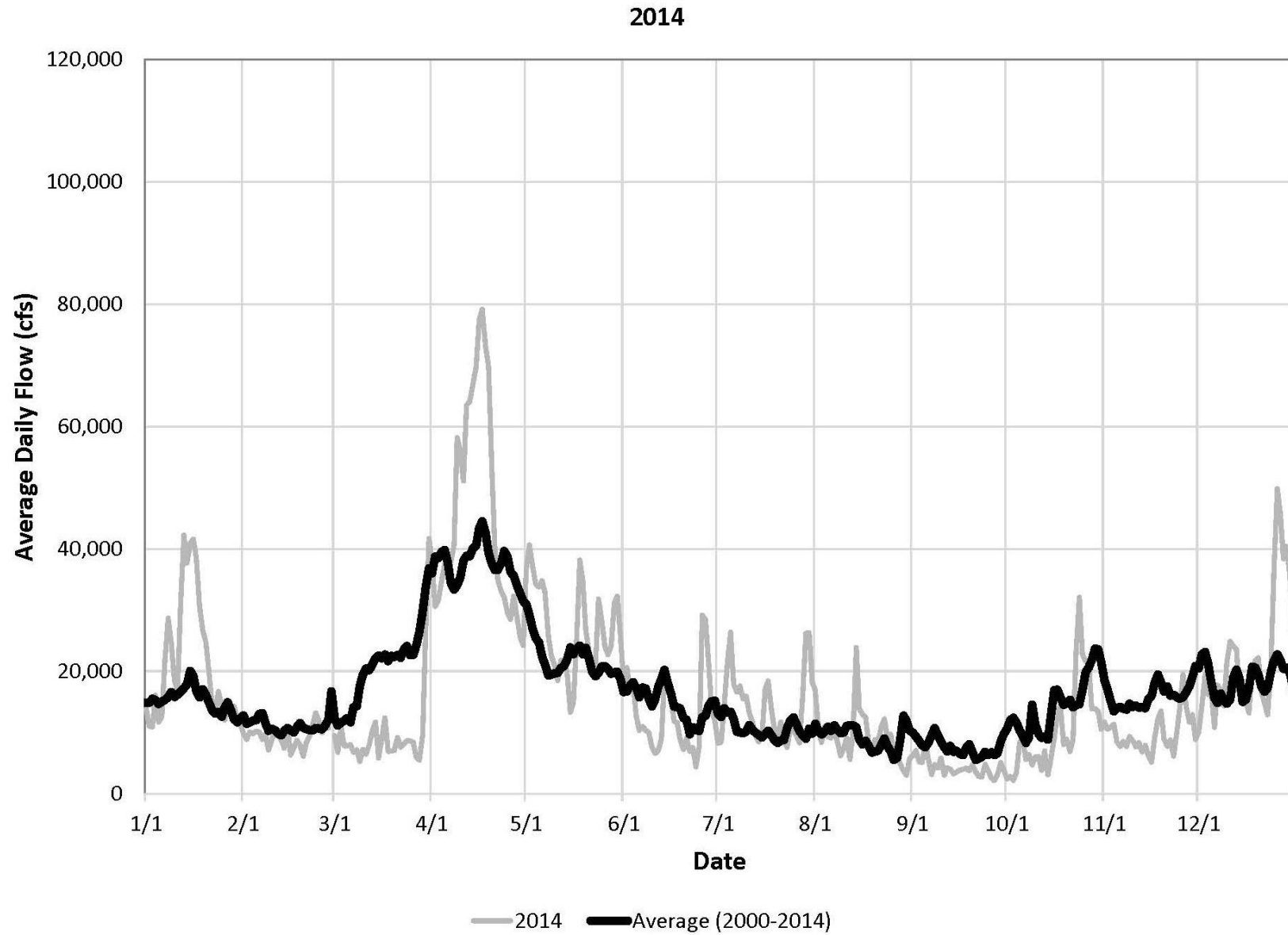
**Figure J-4.30 Location of photo #9307**



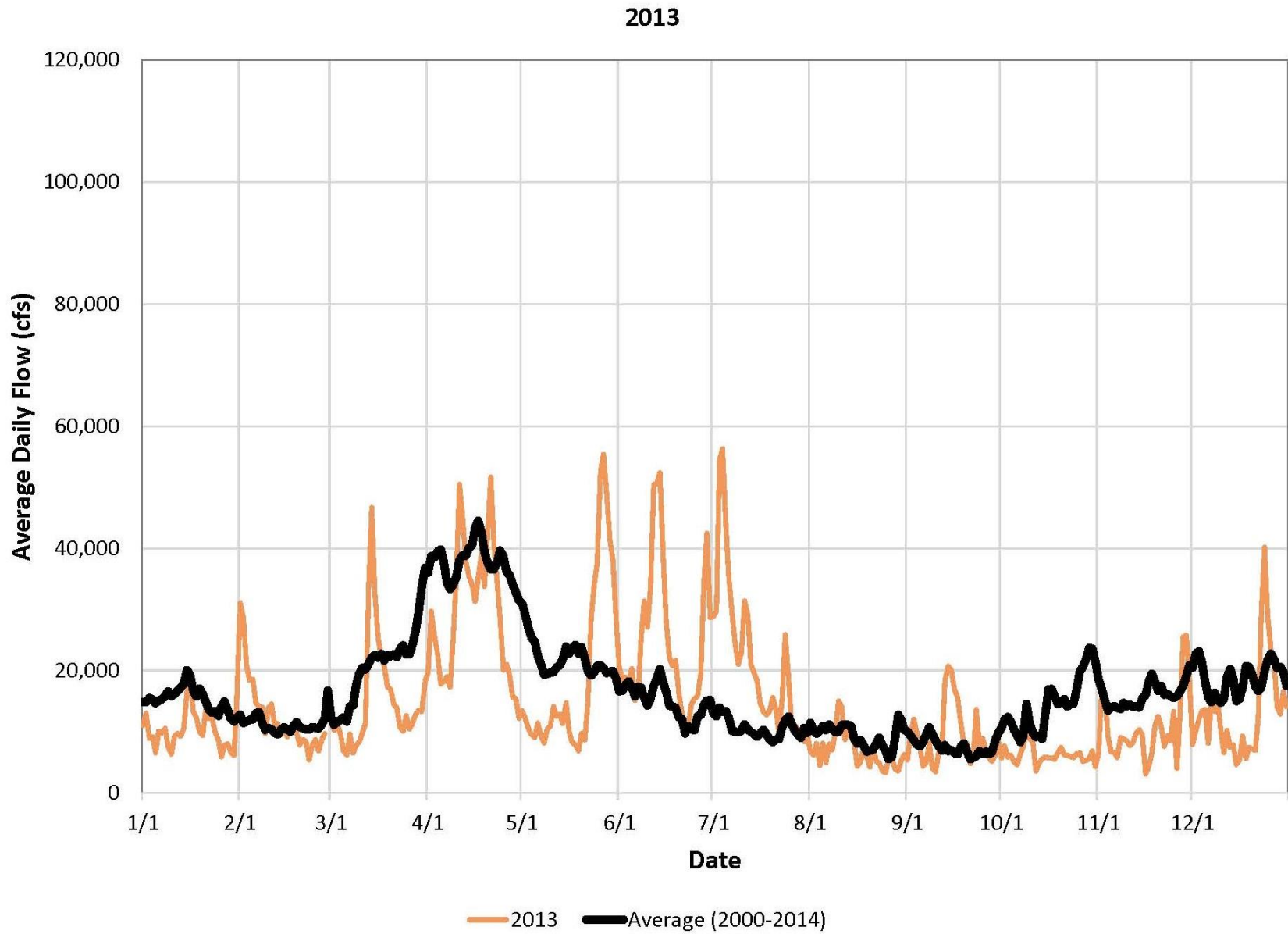


**APPENDIX K – ANNUAL  
HYDROGRAPHS AT MONTAGUE, MA  
(2000-2014)**

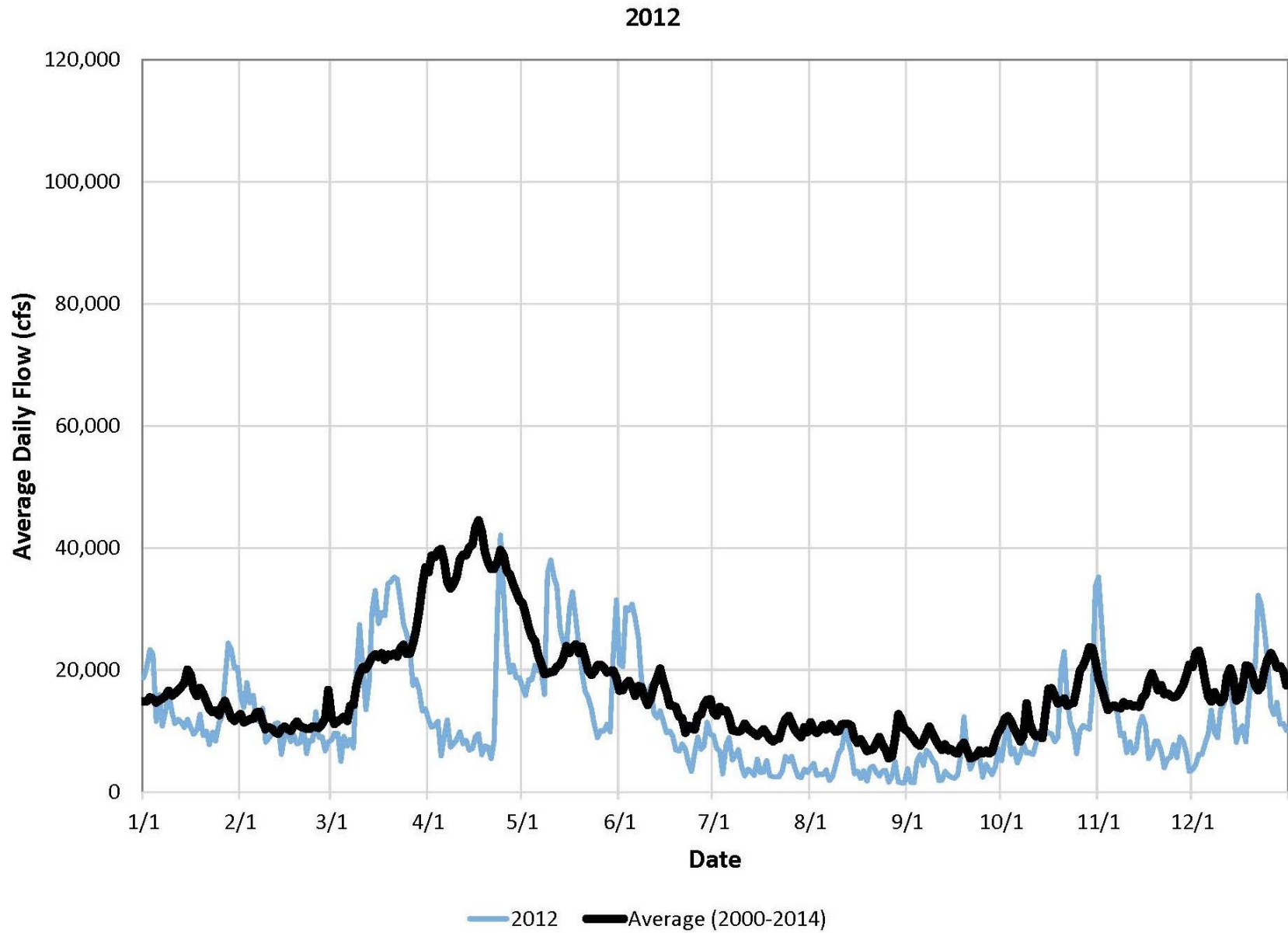
STUDY 3.1.2 NORTHFIELD MOUNTAIN / TURNERS FALLS OPERATIONS IMPACTS ON EXISTING EROSION AND POTENTIAL BANK INSTABILITY



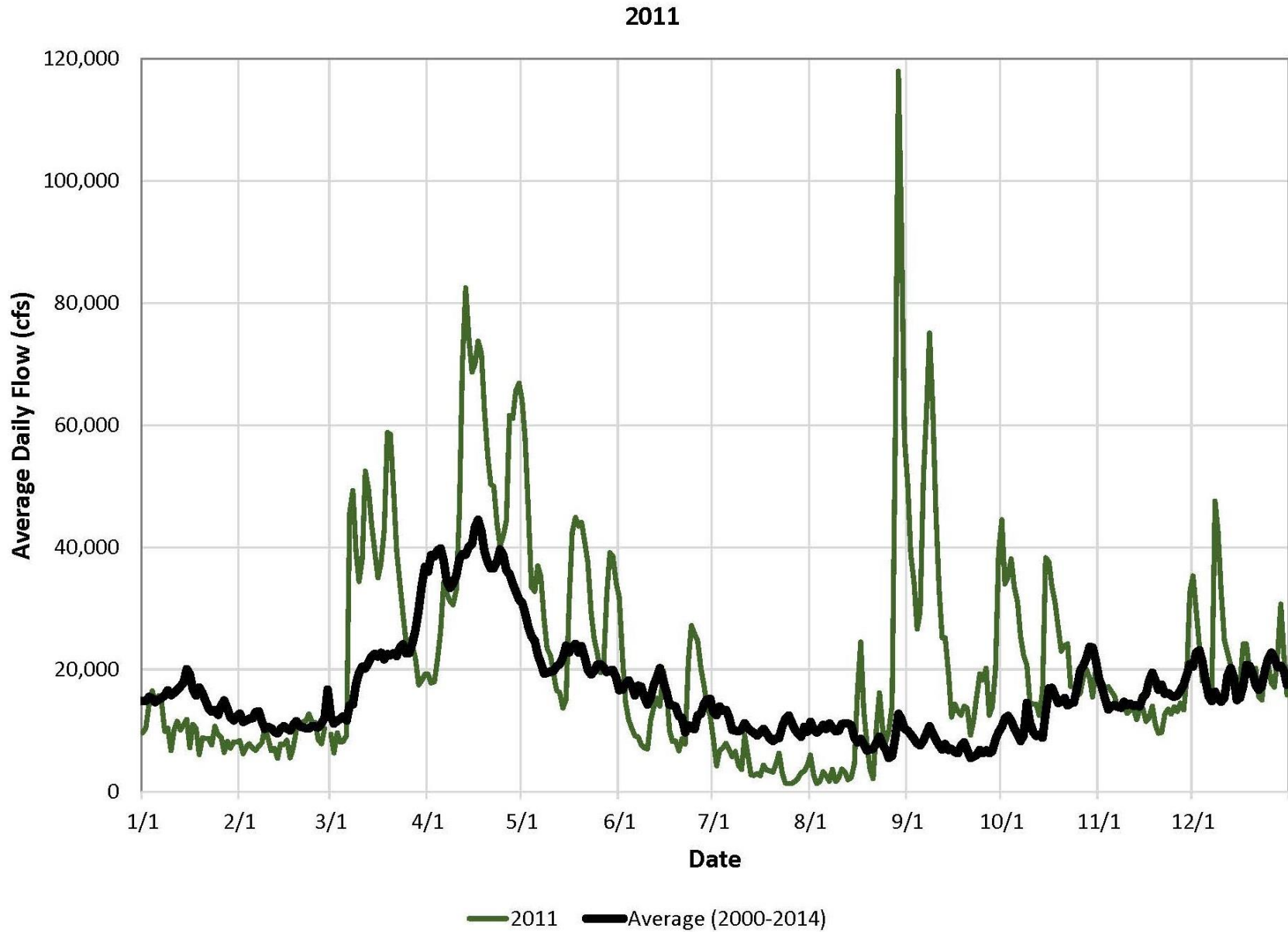
STUDY 3.1.2 NORTHFIELD MOUNTAIN / TURNERS FALLS OPERATIONS IMPACTS ON EXISTING EROSION AND POTENTIAL BANK INSTABILITY



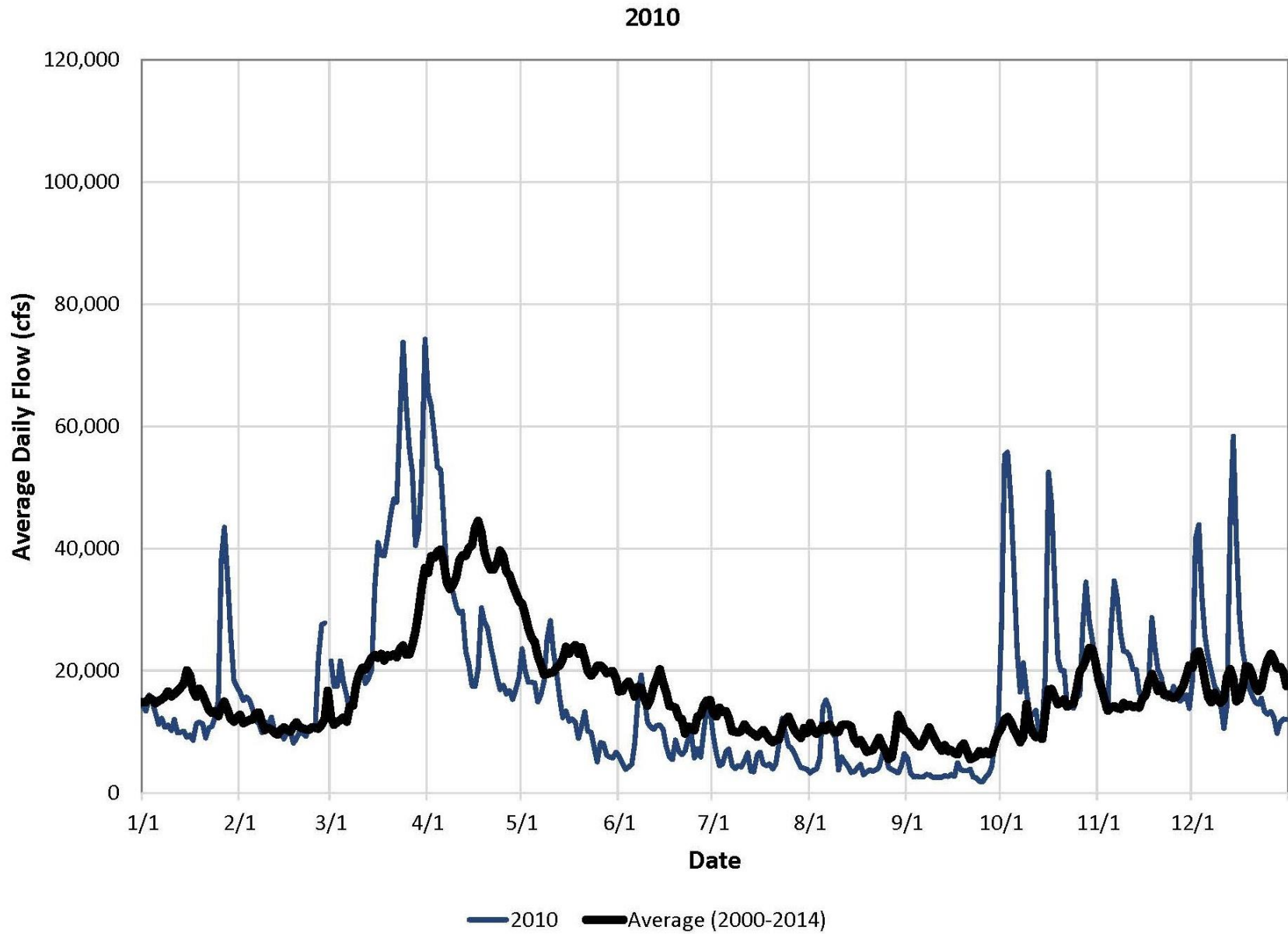
STUDY 3.1.2 NORTHFIELD MOUNTAIN / TURNERS FALLS OPERATIONS IMPACTS ON EXISTING EROSION AND POTENTIAL BANK INSTABILITY



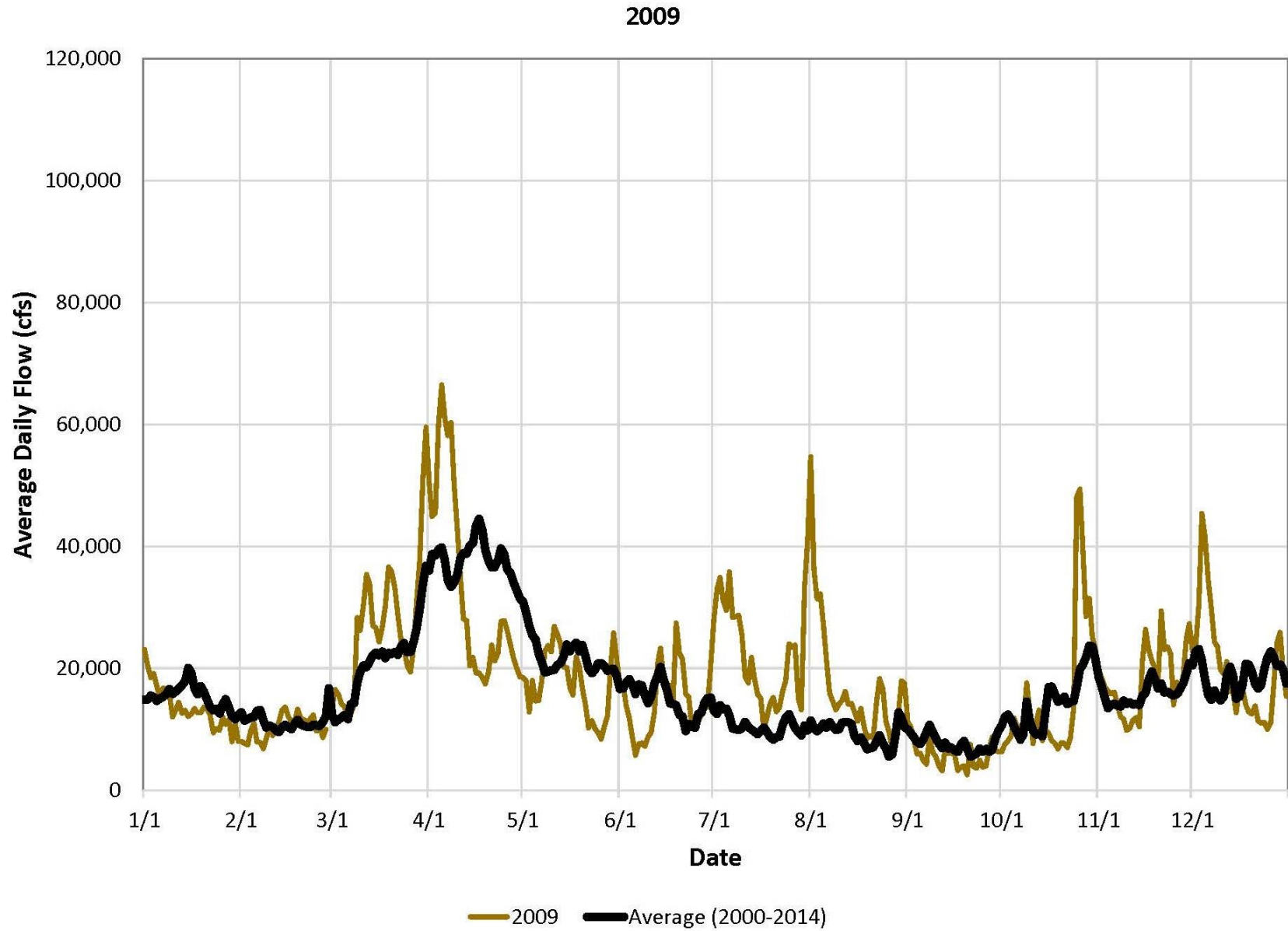
STUDY 3.1.2 NORTHFIELD MOUNTAIN / TURNERS FALLS OPERATIONS IMPACTS ON EXISTING EROSION AND POTENTIAL BANK INSTABILITY



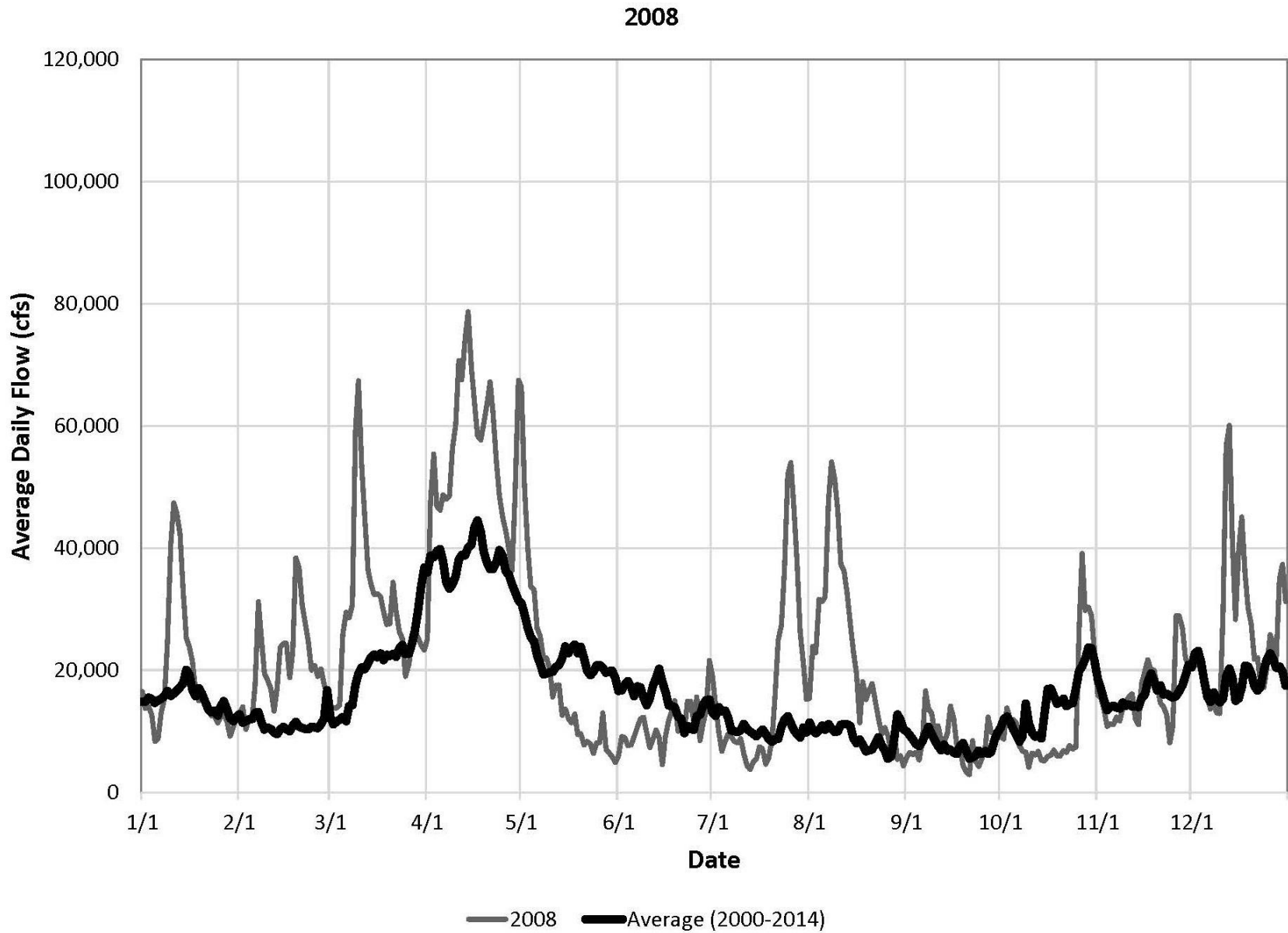
STUDY 3.1.2 NORTHFIELD MOUNTAIN / TURNERS FALLS OPERATIONS IMPACTS ON EXISTING EROSION AND POTENTIAL BANK INSTABILITY



STUDY 3.1.2 NORTHFIELD MOUNTAIN / TURNERS FALLS OPERATIONS IMPACTS ON EXISTING EROSION AND POTENTIAL BANK INSTABILITY

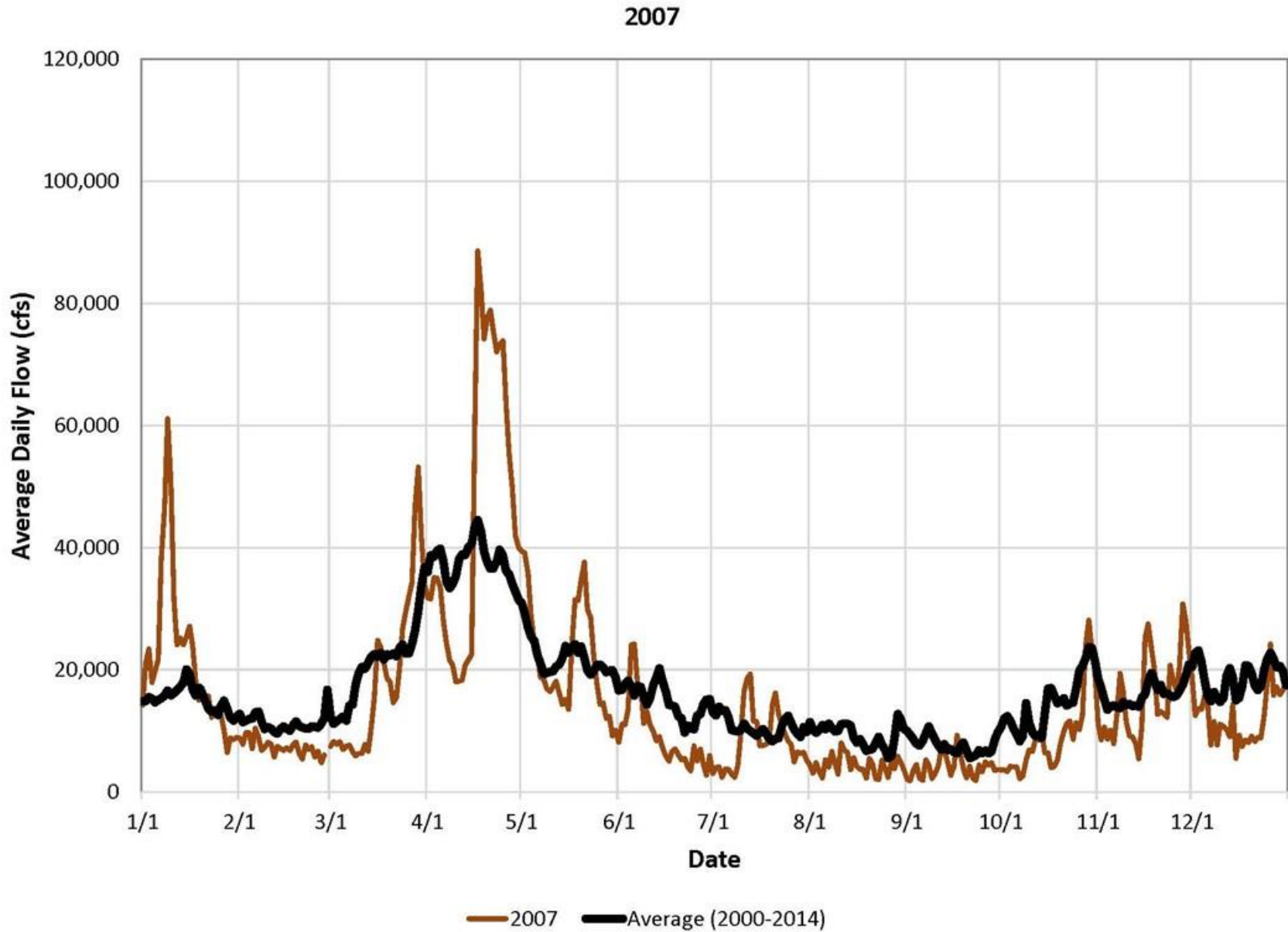


STUDY 3.1.2 NORTHFIELD MOUNTAIN / TURNERS FALLS OPERATIONS IMPACTS ON EXISTING EROSION AND POTENTIAL BANK INSTABILITY

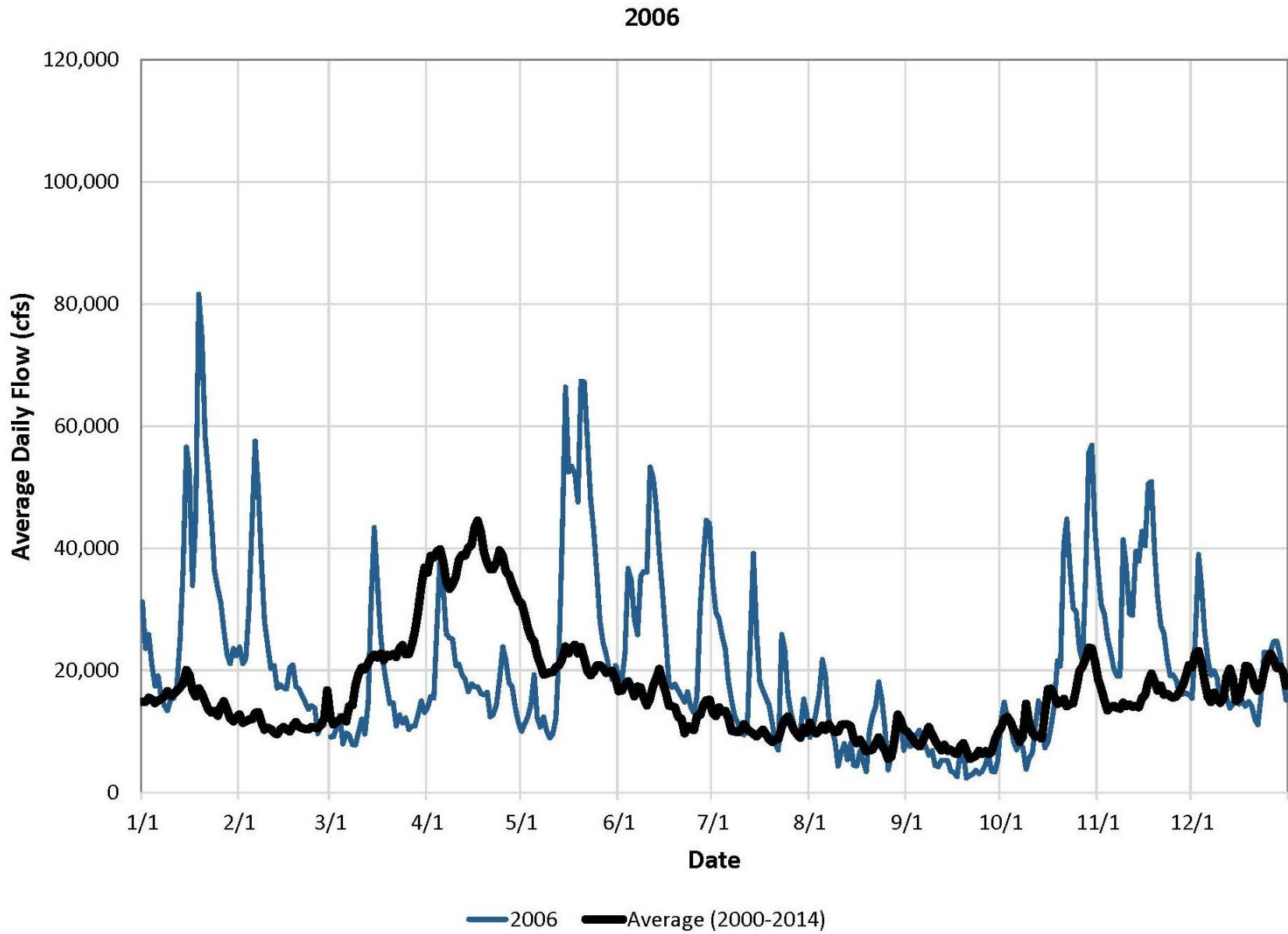




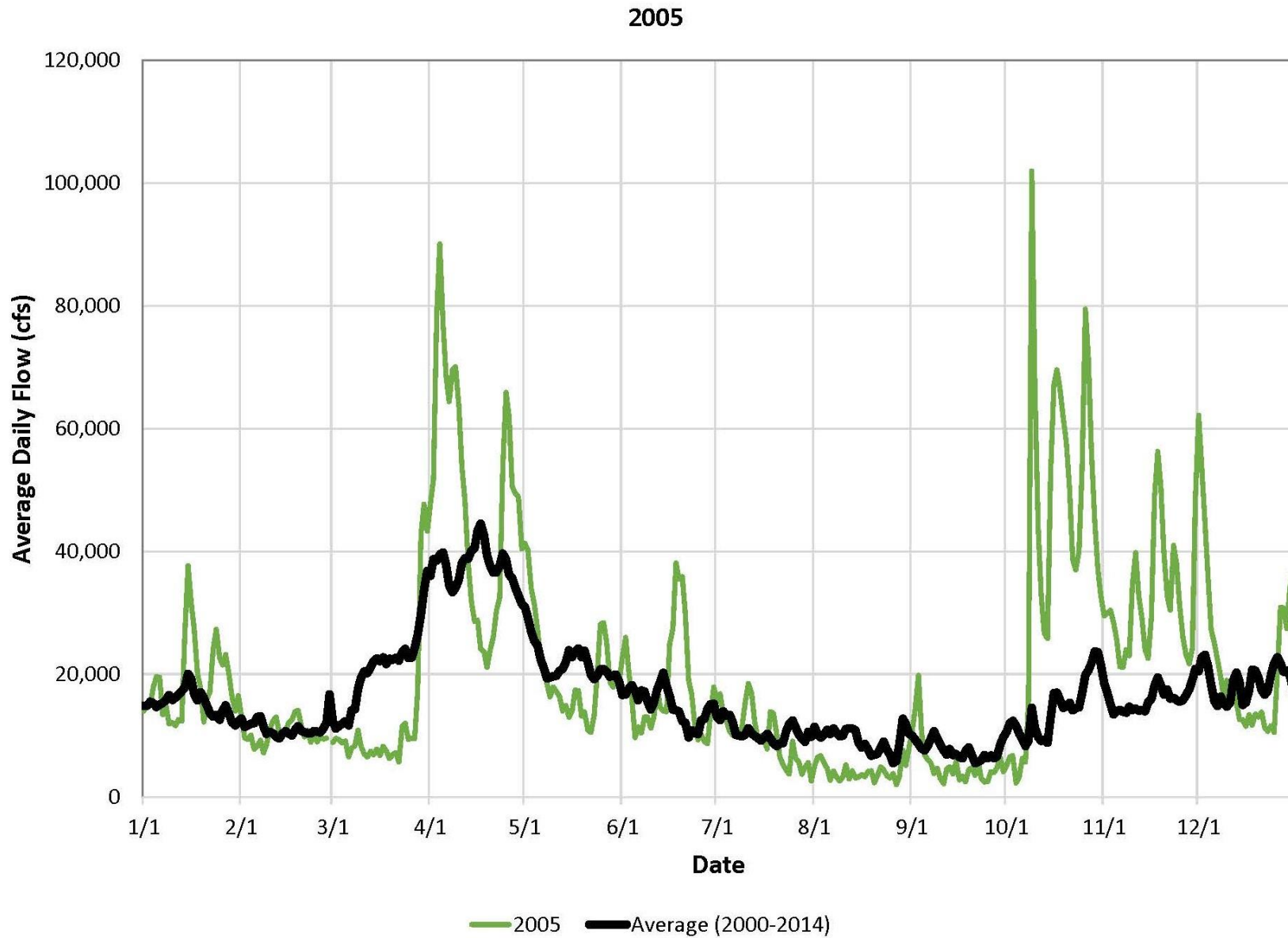
STUDY 3.1.2 NORTHFIELD MOUNTAIN / TURNERS FALLS OPERATIONS IMPACTS ON EXISTING EROSION AND POTENTIAL BANK INSTABILITY



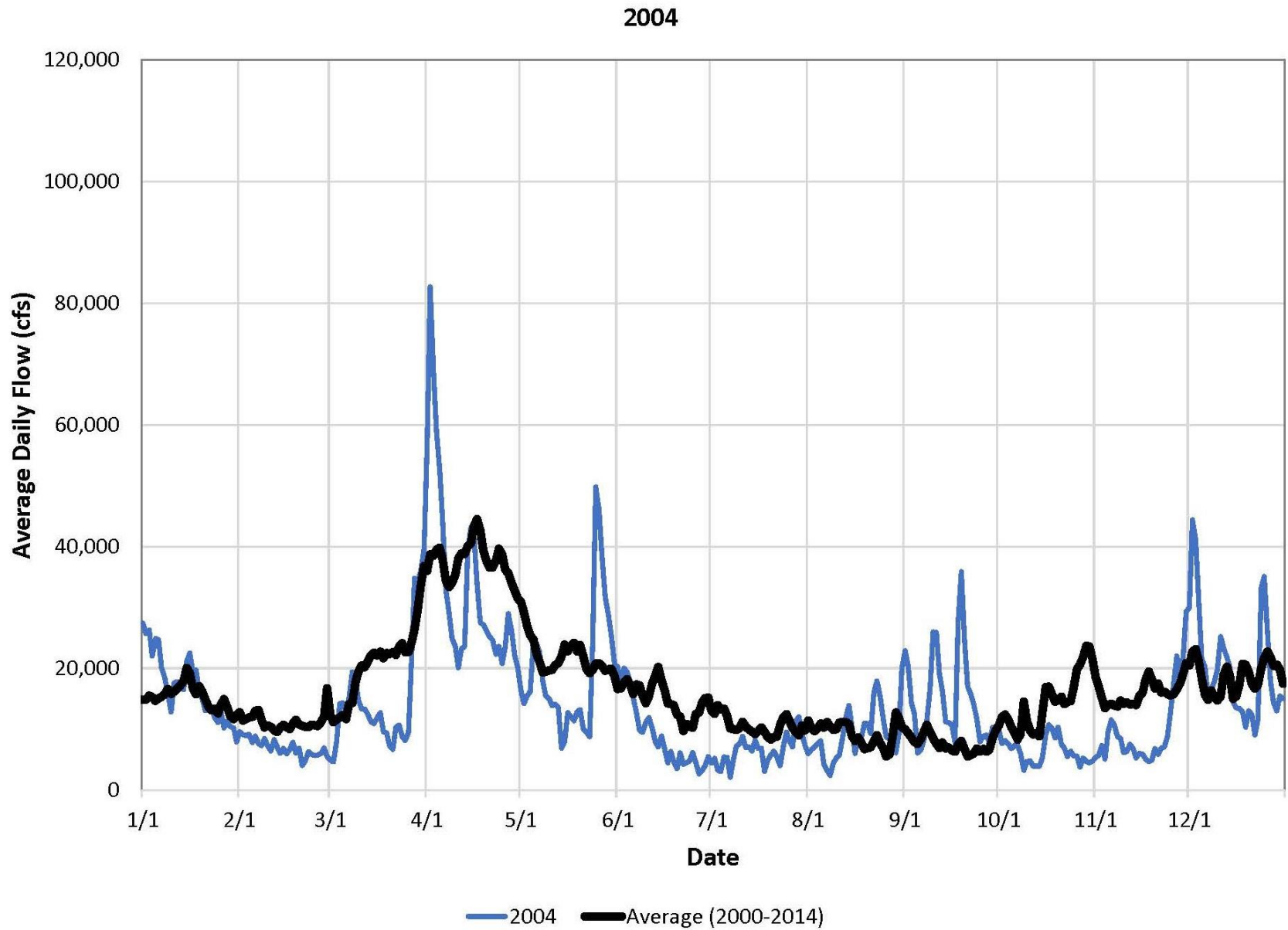
STUDY 3.1.2 NORTHFIELD MOUNTAIN / TURNERS FALLS OPERATIONS IMPACTS ON EXISTING EROSION AND POTENTIAL BANK INSTABILITY



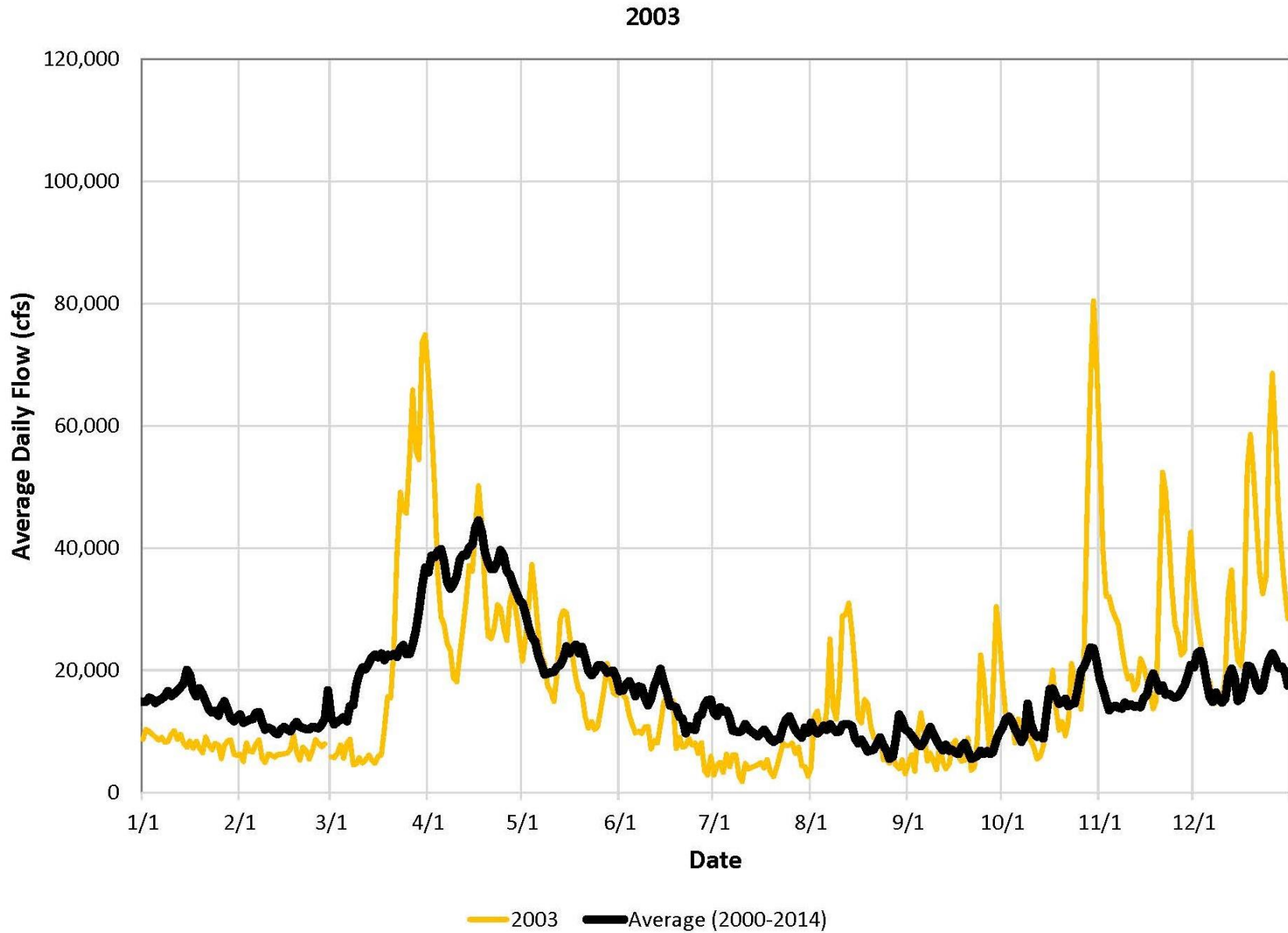
STUDY 3.1.2 NORTHFIELD MOUNTAIN / TURNERS FALLS OPERATIONS IMPACTS ON EXISTING EROSION AND POTENTIAL BANK INSTABILITY



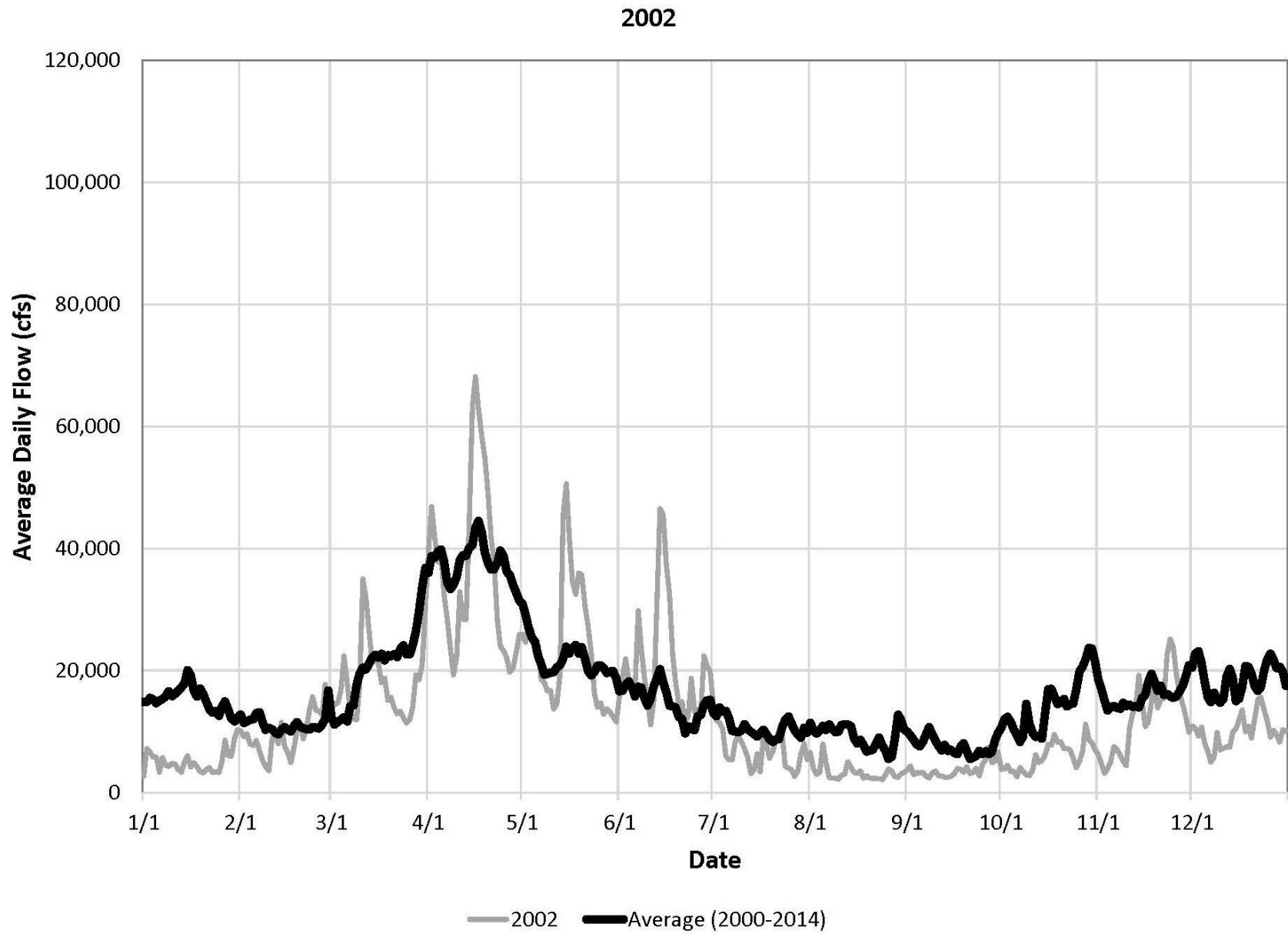
STUDY 3.1.2 NORTHFIELD MOUNTAIN / TURNERS FALLS OPERATIONS IMPACTS ON EXISTING EROSION AND POTENTIAL BANK INSTABILITY



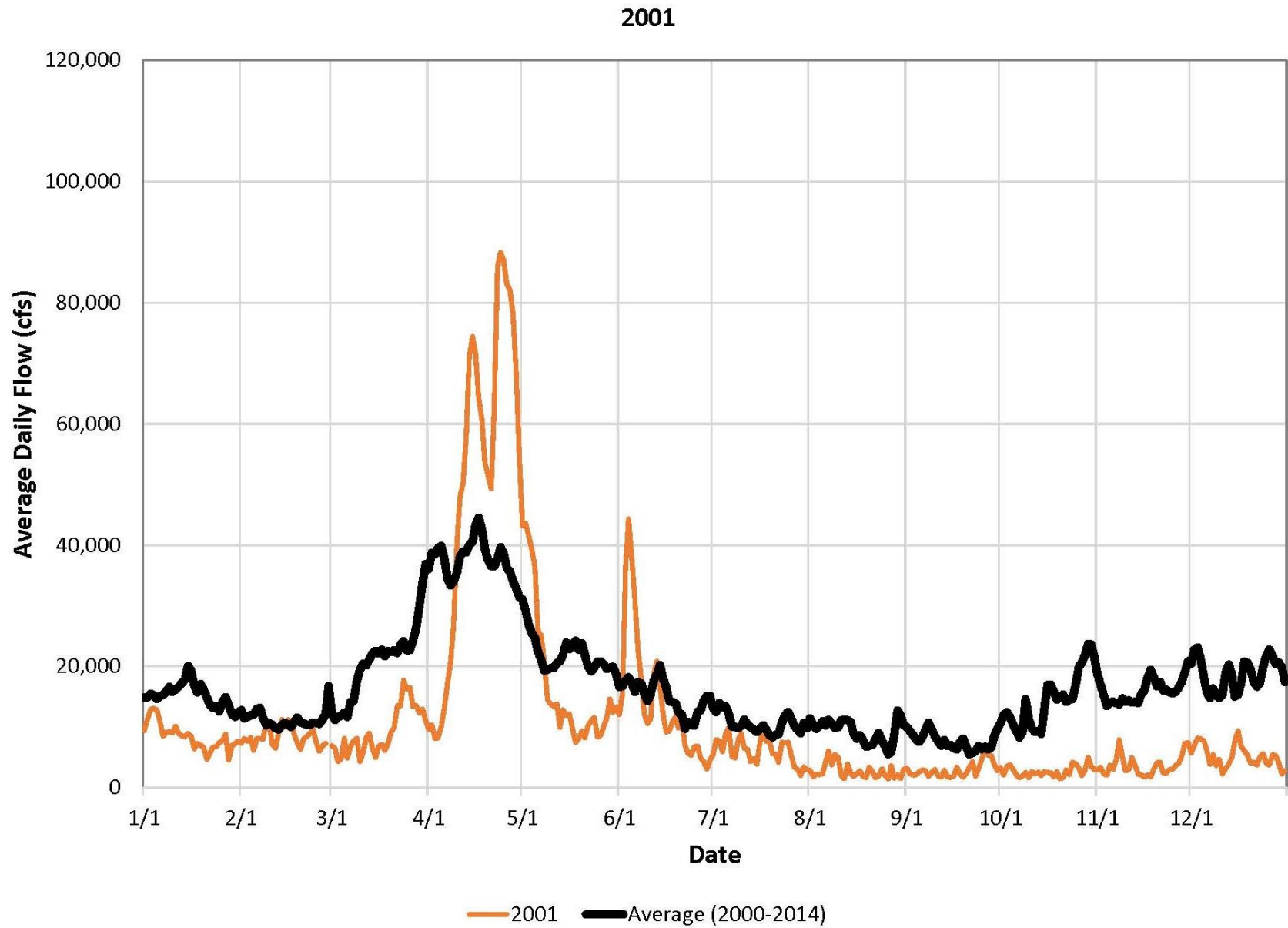
STUDY 3.1.2 NORTHFIELD MOUNTAIN / TURNERS FALLS OPERATIONS IMPACTS ON EXISTING EROSION AND POTENTIAL BANK INSTABILITY



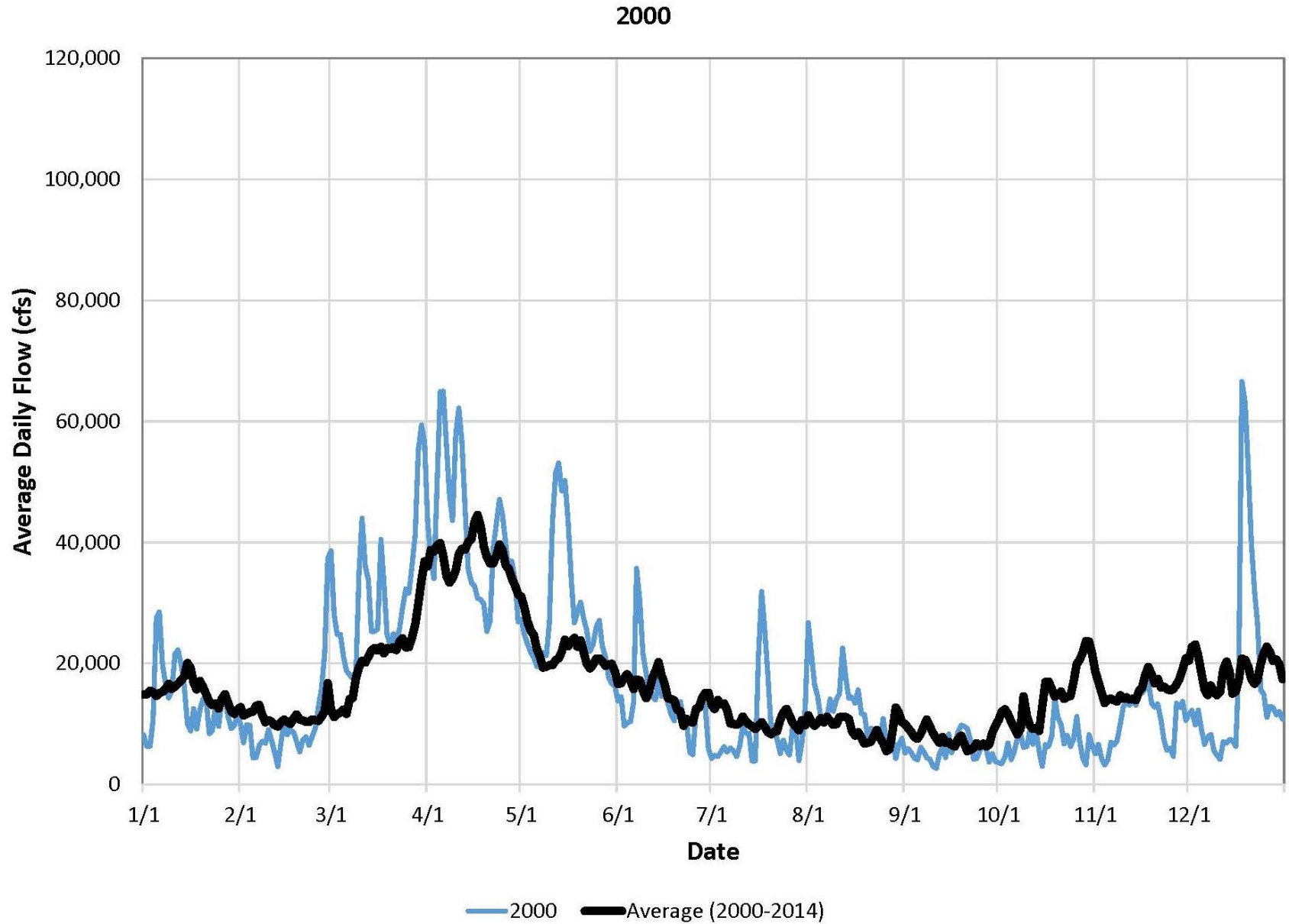
STUDY 3.1.2 NORTHFIELD MOUNTAIN / TURNERS FALLS OPERATIONS IMPACTS ON EXISTING EROSION AND POTENTIAL BANK INSTABILITY



STUDY 3.1.2 NORTHFIELD MOUNTAIN / TURNERS FALLS OPERATIONS IMPACTS ON EXISTING EROSION AND POTENTIAL BANK INSTABILITY



STUDY 3.1.2 NORTHFIELD MOUNTAIN / TURNERS FALLS OPERATIONS IMPACTS ON EXISTING EROSION AND POTENTIAL BANK INSTABILITY





## **APPENDIX L – BSTEM INPUT DATA**

Northfield Mountain Pumped Storage Project (No. 2485) and Turners Falls Hydroelectric Project (No. 1889)

STUDY 3.1.2 NORTHFIELD MOUNTAIN / TURNERS FALLS OPERATIONS IMPACTS ON EXISTING EROSION AND POTENTIAL BANK INSTABILITY

2L Pre-Restoration												
Material Descripti	Bank Model Input Data					Groundwater Model Input Data			Toe Model Input Data		Roughness	Comments
Layer Number	Friction angle $f^b$ (degrees)	Cohesion $c'$ (kPa)	Saturated unit weight ( $kN/m^3$ )	$f^b$ (degrees)	Chemical concentrati on (kg/kg)	Hydraulic Conductivity $k_{sat}$ (m/s)	van Genuchten $a$ (1/m)	van Genuchten $n$	$\tau_c$ (Pa)	$k$ ( $cm^3/Ns$ )	Manning $n$ ( $s/m^{1/3}$ )	
Layer 1	33.7	1.6	18.5	10.0	-	2.823E-05	1.5070	1.8410	0.27	0.384	0.034	MJ2 6.2 due to roots Tc*10 for exposed roots from d50 of 0.1 mm * 10 for roots
Layer 2	33.7	7.8	18.5	10.0	-	2.823E-05	1.5073	1.8413	2.70	0.122	0.045	
Layer 3	20.5	31.3	18.0	10.0	-	9.150E-06	0.6577	1.6788	2.70	0.122	0.064	
Layer 4	20.5	25.1	18.0	10.0	-	9.150E-06	0.6577	1.6788	0.70	0.239	0.017	

2L Post-Restoration												
Material Descripti	Bank Model Input Data					Groundwater Model Input Data			Toe Model Input Data		Roughness	Comments
Layer Number	Friction angle $f^b$ (degrees)	Cohesion $c'$ (kPa)	Saturated unit weight ( $kN/m^3$ )	$f^b$ (degrees)	Chemical concentrati on (kg/kg)	Hydraulic Conductivity $k_{sat}$ (m/s)	van Genuchten $a$ (1/m)	van Genuchten $n$	$\tau_c$ (Pa)	$k$ ( $cm^3/Ns$ )	Manning $n$ ( $s/m^{1/3}$ )	
Layer 1	33.7	1.6	18.5	10.0	-	2.823E-05	1.5070	1.8410	0.27	0.384	0.050	MJ2 6.2 due to roots Tc*10 for exposed roots from d50 of 0.1 mm * 10 for roots
Layer 2	33.7	7.8	18.5	10.0	-	2.823E-05	1.5073	1.8413	2.70	0.122	0.055	
Layer 3	20.5	31.3	18.0	10.0	-	9.150E-06	0.6577	1.6788	2.70	0.122	0.064	
Layer 4	20.5	25.1	18.0	10.0	-	9.150E-06	0.6577	1.6788	0.70	0.239	0.048	

3L													
Material Descriptors		Bank Model Input Data					Groundwater Model Input Data			Toe Model Input Data		Roughness	Comments
Layer Number	Layer Depth	Friction angle $f^b$ (degrees)	Cohesion $c'$ (kPa)	Saturated unit weight ( $kN/m^3$ )	$f^b$ (degrees)	Chemical concentrati on (kg/kg)	Hydraulic Conductivity $k_{sat}$ (m/s)	van Genuchten $a$ (1/m)	van Genuchten $n$	$\tau_c$ (Pa)	$k$ ( $cm^3/Ns$ )	Manning $n$ ( $s/m^{1/3}$ )	
Layer 1	1.61	34.4	0.0	18.0	10.0	-	2.823E-05	1.5073	1.8413	0.33	60.000	0.016	based on MJ4
Layer 2	1.00	34.4	0.0	18.0	10.0	-	2.823E-05	1.5073	1.8413	0.33	25.000	0.016	based on MJ4
Layer 3	1.87	26.0	17.7	18.0	10.0	-	2.823E-05	1.5073	1.8413	0.18	0.478	0.028	based on MJ 1 and 2 and 2000 geometry
Layer 4	1.65	26.0	17.7	18.0	10.0	-	2.823E-05	1.5073	1.8413	1.75	0.151	0.018	based on MJ 1 and 2 and 2000 geometry

Northfield Mountain Pumped Storage Project (No. 2485) and Turners Falls Hydroelectric Project (No. 1889)

STUDY 3.1.2 NORTHFIELD MOUNTAIN / TURNERS FALLS OPERATIONS IMPACTS ON EXISTING EROSION AND POTENTIAL BANK INSTABILITY

3R Pre Restoration													
Material Descriptors		Bank Model Input Data					Groundwater Model Input Data			Toe Model Input Data		Roughness	Comments
Layer Number	Layer Depth	Friction angle $f^a$ (degrees)	Cohesion $c'$ (kPa)	Saturated unit weight (kN/m <sup>3</sup> )	$f^b$ (degrees)	Chemical concentration (kg/kg)	Hydraulic Conductivity $k_{sat}$ (m/s)	van Genuchten $a$ (1/m)	van Genuchten $n$	$\tau_c$ (Pa)	$k$ (cm <sup>3</sup> /Ns)	Manning $n$ (s/m <sup>1/3</sup> )	
Layer 1	1.92	30.9	1.7	18.0	10.0	-	3.097E-06	2.3570	2.0037	0.66	5.000	0.016	Assuming no Restoration from MJ1
Layer 2	3.39	30.9	1.7	18.0	10.0	-	3.097E-06	2.3570	2.0037	0.66	0.800	0.016	
Layer 3	1.59	31.0	2.1	18.0	10.0	-	3.097E-06	2.3570	2.0037	0.66	0.246	0.030	
Layer 4	0.90	31.0	2.1	18.0	10.0	-	3.097E-06	2.3570	2.0037	0.26	0.391	0.047	
3R Post Restoration													
Material Descriptors		Bank Model Input Data					Groundwater Model Input Data			Toe Model Input Data		Roughness	Comments
Layer Number	Layer Depth	Friction angle $f^a$ (degrees)	Cohesion $c'$ (kPa)	Saturated unit weight (kN/m <sup>3</sup> )	$f^b$ (degrees)	Chemical concentration (kg/kg)	Hydraulic Conductivity $k_{sat}$ (m/s)	van Genuchten $a$ (1/m)	van Genuchten $n$	$\tau_c$ (Pa)	$k$ (cm <sup>3</sup> /Ns)	Manning $n$ (s/m <sup>1/3</sup> )	
Layer 1	1.00	30.9	1.7	18.0	10.0	-	3.097E-06	2.3570	2.0037	0.66	0.246	0.025	$d_{50}$ RipRap = 55.0 mm
Layer 2	3.12	30.9	1.7	18.0	10.0	-	3.097E-06	2.3570	2.0037	0.66	0.246	0.025	
Layer 3	2.51	31.0	2.1	18.0	10.0	-	3.097E-06	2.3570	2.0037	0.66	0.246	0.040	
Layer 4	1.03	42.0	0.0	20.0	10.0	-	1.745E-03	3.5237	2.3286	53.46	0.027	0.060	
4L													
Material Descriptors		Bank Model Input Data					Groundwater Model Input Data			Toe Model Input Data		Roughness	Comments
Layer Number	Layer Depth	Friction angle $f^a$ (degrees)	Cohesion $c'$ (kPa)	Saturated unit weight (kN/m <sup>3</sup> )	$f^b$ (degrees)	Chemical concentration (kg/kg)	Hydraulic Conductivity $k_{sat}$ (m/s)	van Genuchten $a$ (1/m)	van Genuchten $n$	$\tau_c$ (Pa)	$k$ (cm <sup>3</sup> /Ns)	Manning $n$ (s/m <sup>1/3</sup> )	
Layer 1	1.00	32.8	0.0	18.0	10.0	-	2.823E-05	1.5073	1.8413	1.30	0.175	0.050	$\tau_c$ *10 for exposed roots $\tau_c$ *10 for exposed roots, $c'$ added 5.2 due to roots $\tau_c$ *10 for exposed roots, $c'$ added 5.2 due to roots $\tau_c$ *10 for exposed roots
Layer 2	1.50	32.8	5.2	18.0	10.0	-	2.823E-05	1.5073	1.8413	1.30	0.175	0.050	
Layer 3	1.25	32.8	5.2	18.0	10.0	-	2.823E-05	1.5073	1.8413	1.30	0.175	0.050	
Layer 4	1.19	32.8	0.0	18.0	10.0	-	2.823E-05	1.5073	1.8413	1.30	0.175	0.040	

Northfield Mountain Pumped Storage Project (No. 2485) and Turners Falls Hydroelectric Project (No. 1889)

STUDY 3.1.2 NORTHFIELD MOUNTAIN / TURNERS FALLS OPERATIONS IMPACTS ON EXISTING EROSION AND POTENTIAL BANK INSTABILITY

5CR													
Material Descriptors		Bank Model Input Data					Groundwater Model Input Data			Toe Model Input Data		Roughness	Comments
Layer Number	Layer Depth	Friction angle $f^a$ (degrees)	Cohesion $c'$ (kPa)	Saturated unit weight (kN/m <sup>3</sup> )	$f^b$ (degrees)	Chemical concentration (kg/kg)	Hydraulic Conductivity $k_{sat}$ (m/s)	van Genuchten $a$ (1/m)	van Genuchten $n$	$\tau_c$ (Pa)	$k$ (cm <sup>3</sup> /Ns)	Manning $n$ (s/m <sup>1/3</sup> )	
Layer 1	1.00	31.0	2.9	18.0	10.0	-	2.823E-05	1.5073	1.8413	8.70	0.068	0.030	avg MJ 6&7 $\tau_c$ *10 for exposed roots
Layer 2	2.74	31.0	2.9	18.0	10.0	-	9.150E-06	0.6577	1.6788	0.87	0.195	0.018	avg MJ 6&7
Layer 3	1.97	32.4	5.9	18.0	10.0	-	9.150E-06	0.6577	1.6788	1.03	0.197	0.020	MJ 1
Layer 4	1.41	31.4	4.2	18.0	10.0	-	9.150E-06	0.6577	1.6788	0.13	0.555	0.050	beach-toe sample $d_{50}$ = 0.18 mm
6AR													
Material Descriptors		Bank Model Input Data					Groundwater Model Input Data			Toe Model Input Data		Roughness	Comments
Layer Number	Layer Depth	Friction angle $f^a$ (degrees)	Cohesion $c'$ (kPa)	Saturated unit weight (kN/m <sup>3</sup> )	$f^b$ (degrees)	Chemical concentration (kg/kg)	Hydraulic Conductivity $k_{sat}$ (m/s)	van Genuchten $a$ (1/m)	van Genuchten $n$	$\tau_c$ (Pa)	$k$ (cm <sup>3</sup> /Ns)	Manning $n$ (s/m <sup>1/3</sup> )	
Layer 1	1.00	29.5	6.1	18.0	10.0	-	2.820E-05	1.5073	1.8413	0.54	0.272	0.030	Avg. MJ 1 and 6
Layer 2	1.85	33.3	2.2	18.0	10.0	-	9.170E-05	3.2066	2.1662	0.54	0.272	0.030	Avg. MJ 1 and 6
Layer 3	3.58	33.7	0.0	18.0	10.0	-	9.170E-05	3.2066	2.1662	0.80	0.223	0.030	MJ 3
Layer 4	1.07	33.7	0.0	18.0	10.0	-	9.170E-05	3.2066	2.1662	0.71	0.237	0.030	Assume 1mm SP
6AL Pre Restoration													
Material Descriptors		Bank Model Input Data					Groundwater Model Input Data			Toe Model Input Data		Roughness	Comments
Layer Number	Layer Depth	Friction angle $f^a$ (degrees)	Cohesion $c'$ (kPa)	Saturated unit weight (kN/m <sup>3</sup> )	$f^b$ (degrees)	Chemical concentration (kg/kg)	Hydraulic Conductivity $k_{sat}$ (m/s)	van Genuchten $a$ (1/m)	van Genuchten $n$	$\tau_c$ (Pa)	$k$ (cm <sup>3</sup> /Ns)	Manning $n$ (s/m <sup>1/3</sup> )	
Layer 1	5.12	33.2	0.0	18.0	10.0	-	9.150E-06	0.6577	1.6788	0.44	0.291	0.060	Avg. MJ 3&4
Layer 2	2.32	33.2	0.0	18.0	10.0	-	9.150E-06	0.6577	1.6788	0.44	3.198	0.016	Avg. MJ 3&4 +High k
Layer 3	2.55	33.2	0.0	18.0	10.0	-	9.150E-06	0.6577	1.6788	0.44	2.000	0.016	Avg. MJ 3&4 since Restoration and assume sand sized material from upper tests
Layer 4	1.22	29.5	8.0	18.0	10.0	-	9.150E-06	0.6577	1.6788	0.71	0.237	0.040	assume $d_{50}$ =1 mm (1998)

Northfield Mountain Pumped Storage Project (No. 2485) and Turners Falls Hydroelectric Project (No. 1889)

STUDY 3.1.2 NORTHFIELD MOUNTAIN / TURNERS FALLS OPERATIONS IMPACTS ON EXISTING EROSION AND POTENTIAL BANK INSTABILITY

6AL Post Restoration													
Material Descriptors		Bank Model Input Data					Groundwater Model Input Data			Toe Model Input Data		Roughness	Comments
Layer Number	Layer Depth	Friction angle $f^a$ (degrees)	Cohesion $c'$ (kPa)	Saturated unit weight (kN/m <sup>3</sup> )	$f^b$ (degrees)	Chemical concentration (kg/kg)	Hydraulic Conductivity $k_{sat}$ (m/s)	van Genuchten $a$ (1/m)	van Genuchten $n$	$\tau_c$ (Pa)	$k$ (cm <sup>3</sup> /Ns)	Manning $n$ (s/m <sup>1/3</sup> )	
Layer 1	1.00	33.2	0.0	18.0	10.0	-	9.150E-06	0.6577	1.6788	0.47	0.291	0.040	Avg. MJ1&2
Layer 2	3.96	33.2	0.0	18.0	10.0	-	9.150E-06	0.6577	1.6788	0.47	0.291	0.040	Avg. MJ1&2
Layer 3	4.87	29.5	8.0	18.0	10.0	-	9.150E-06	0.6577	1.6788	2.05	0.140	0.035	Avg. MJ 3&4
Layer 4	1.92	29.5	8.0	18.0	10.0	-	1.745E-03	3.5237	2.3286	53.46	0.027	0.040	$d_{50}$ particle Count = 57.0 mm

7L													
Material Descriptors		Bank Model Input Data					Groundwater Model Input Data			Toe Model Input Data		Roughness	Comments
Layer Number	Layer Depth	Friction angle $f^a$ (degrees)	Cohesion $c'$ (kPa)	Saturated unit weight (kN/m <sup>3</sup> )	$f^b$ (degrees)	Chemical concentration (kg/kg)	Hydraulic Conductivity $k_{sat}$ (m/s)	van Genuchten $a$ (1/m)	van Genuchten $n$	$\tau_c$ (Pa)	$k$ (cm <sup>3</sup> /Ns)	Manning $n$ (s/m <sup>1/3</sup> )	
Layer 1	3.90	26.6	15.7	18.0	10.0	-	2.823E-05	1.5073	1.8413	0.75	0.231	0.060	avg, MJ1 & 2
Layer 2	1.63	26.6	0.0	18.0	10.0	-	2.823E-05	1.5073	1.8413	0.75	1.500	0.016	avg, MJ1 & 2
Layer 3	1.61	35.3	0.0	18.0	10.0	-	9.174E-05	3.2066	2.1662	0.75	0.231	0.030	avg, MJ1 & 2
Layer 4	1.36	35.3	0.0	18.0	10.0	-	9.174E-05	3.2066	2.1662	0.71	0.350	0.028	assume 1mm $d_{50}$

7R													
Material Descriptors		Bank Model Input Data					Groundwater Model Input Data			Toe Model Input Data		Roughness	Comments
Layer Number	Layer Depth	Friction angle $f^a$ (degrees)	Cohesion $c'$ (kPa)	Saturated unit weight (kN/m <sup>3</sup> )	$f^b$ (degrees)	Chemical concentration (kg/kg)	Hydraulic Conductivity $k_{sat}$ (m/s)	van Genuchten $a$ (1/m)	van Genuchten $n$	$\tau_c$ (Pa)	$k$ (cm <sup>3</sup> /Ns)	Manning $n$ (s/m <sup>1/3</sup> )	
Layer 1	2.71	29.7	0.0	18.0	10.0	-	1.411E-04	4.0563	2.3286	10.00	1.000	0.016	MJ 3&4
Layer 2	1.65	29.0	12.2	18.0	10.0	-	1.411E-04	4.0563	2.3286	1.46	0.400	0.016	MJ 1&2
Layer 3	1.58	31.3	16.1	18.0	10.0	-	9.150E-06	0.6577	1.6788	1.46	0.166	0.025	MJ 1&2
Layer 4	1.50	31.3	5.6	18.0	10.0	-	9.150E-06	0.6577	1.6788	0.70	0.239	0.035	$d_{50} = 0.105$ mm x10 for veg

Northfield Mountain Pumped Storage Project (No. 2485) and Turners Falls Hydroelectric Project (No. 1889)

STUDY 3.1.2 NORTHFIELD MOUNTAIN / TURNERS FALLS OPERATIONS IMPACTS ON EXISTING EROSION AND POTENTIAL BANK INSTABILITY

8L													
Material Descriptors		Bank Model Input Data					Groundwater Model Input Data			Toe Model Input Data		Roughness	Comments
Layer Number	Layer Depth	Friction angle $f^a$ (degrees)	Cohesion $c'$ (kPa)	Saturated unit weight (kN/m <sup>3</sup> )	$f^b$ (degrees)	Chemical concentration (kg/kg)	Hydraulic Conductivity $k_{sat}$ (m/s)	van Genuchten $a$ (1/m)	van Genuchten $n$	$\tau_c$ (Pa)	$k$ (cm <sup>3</sup> /Ns)	Manning $n$ (s/m <sup>1/3</sup> )	
Layer 1	1.00	33.2	0.0	18.0	10.0	-	2.820E-06	0.6577	1.6788	3.33	0.110	0.050	c' added 6.1 kPa for veg d <sub>50</sub> = 7.0 mm
Layer 2	2.60	33.2	6.1	18.0	10.0	-	2.820E-06	0.6577	1.6788	3.33	0.110	0.050	
Layer 3	1.15	33.2	6.1	18.0	10.0	-	9.150E-06	0.6577	1.6788	3.33	3.000	0.016	
Layer 4	2.55	33.2	0.0	18.0	10.0	-	9.150E-06	0.6577	1.6788	6.80	0.077	0.050	

8R Pre Restoration													
Material Descriptors		Bank Model Input Data					Groundwater Model Input Data			Toe Model Input Data		Roughness	Comments
Layer Number	Layer Depth	Friction angle $f^a$ (degrees)	Cohesion $c'$ (kPa)	Saturated unit weight (kN/m <sup>3</sup> )	$f^b$ (degrees)	Chemical concentration (kg/kg)	Hydraulic Conductivity $k_{sat}$ (m/s)	van Genuchten $a$ (1/m)	van Genuchten $n$	$\tau_c$ (Pa)	$k$ (cm <sup>3</sup> /Ns)	Manning $n$ (s/m <sup>1/3</sup> )	
Layer 1	1.00	28.1	6.1	18.0	10.0	-	2.823E-05	1.5073	1.8413	0.63	2.380	0.016	Avg, MJ1 & 2 c' added 1.7 kPa for veg
Layer 2	1.80	33.7	3.2	18.0	10.0	-	2.823E-05	1.5073	1.8413	0.63	2.380	0.016	
Layer 3	1.69	32.9	14.4	18.0	10.0	-	2.823E-05	1.5073	1.8413	0.63	0.810	0.016	
Layer 4	1.37	32.9	12.7	18.0	10.0	-	2.823E-05	1.5073	1.8413	0.63	0.253	0.030	

8R Post Restoration													
Material Descriptors		Bank Model Input Data					Groundwater Model Input Data			Toe Model Input Data		Roughness	Comments
Layer Number	Layer Depth	Friction angle $f^a$ (degrees)	Cohesion $c'$ (kPa)	Saturated unit weight (kN/m <sup>3</sup> )	$f^b$ (degrees)	Chemical concentration (kg/kg)	Hydraulic Conductivity $k_{sat}$ (m/s)	van Genuchten $a$ (1/m)	van Genuchten $n$	$\tau_c$ (Pa)	$k$ (cm <sup>3</sup> /Ns)	Manning $n$ (s/m <sup>1/3</sup> )	
Layer 1	1.00	28.1	6.1	18.0	10.0	-	2.823E-05	1.5073	1.8413	0.63	2.380	0.016	Avg, MJ1 & 2
Layer 2	1.80	33.7	3.2	18.0	10.0	-	2.823E-05	1.5073	1.8413	0.63	2.380	0.016	
Layer 3	1.69	32.9	14.4	18.0	10.0	-	2.823E-05	1.5073	1.8413	0.63	0.810	0.016	
Layer 4	1.37	32.9	12.7	18.0	10.0	-	2.823E-05	1.5073	1.8413	14.58	0.052	0.030	

Northfield Mountain Pumped Storage Project (No. 2485) and Turners Falls Hydroelectric Project (No. 1889)

STUDY 3.1.2 NORTHFIELD MOUNTAIN / TURNERS FALLS OPERATIONS IMPACTS ON EXISTING EROSION AND POTENTIAL BANK INSTABILITY

9R Pre Restoration													
Material Descriptors		Bank Model Input Data					Groundwater Model Input Data			Toe Model Input Data		Roughness	Comments
Layer Number	Layer Depth	Friction angle $f^a$ (degrees)	Cohesion $c'$ (kPa)	Saturated unit weight (kN/m <sup>3</sup> )	$f^b$ (degrees)	Chemical concentration (kg/kg)	Hydraulic Conductivity $k_{sat}$ (m/s)	van Genuchten $a$ (1/m)	van Genuchten $n$	$\tau_c$ (Pa)	$k$ (cm <sup>3</sup> /Ns)	Manning $n$ (s/m <sup>1/3</sup> )	
Layer 1	12.54	32.3	3.9	18.0	10.0	-	9.174E-05	3.2066	2.1662	0.09	0.667	0.020	from PS sample (.12 mm) + Rip Root value of 3.9 for $c'$
Layer 2	2.59	33.1	3.6	18.0	10.0	-	9.174E-05	3.2066	2.1662	0.29	11.782	0.016	d50 = 0.41 mm + Rip Root value of 3.6 for $c'$
Layer 3	1.92	28.2	18.3	18.0	10.0	-	9.150E-06	1.6788	2.0037	10.30	5.500	0.016	MJ average (new) + Rip Root value of 3.6 for $c'$
Layer 4	1.47	28.2	14.7	18.0	10.0	-	9.150E-06	1.6788	2.0037	0.21	3.500	0.020	d <sub>50</sub> = 0.30 mm

9R Post Restoration													
Material Descriptors		Bank Model Input Data					Groundwater Model Input Data			Toe Model Input Data		Roughness	Comments
Layer Number	Layer Depth	Friction angle $f^a$ (degrees)	Cohesion $c'$ (kPa)	Saturated unit weight (kN/m <sup>3</sup> )	$f^b$ (degrees)	Chemical concentration (kg/kg)	Hydraulic Conductivity $k_{sat}$ (m/s)	van Genuchten $a$ (1/m)	van Genuchten $n$	$\tau_c$ (Pa)	$k$ (cm <sup>3</sup> /Ns)	Manning $n$ (s/m <sup>1/3</sup> )	
Layer 1	12.54	32.3	3.9	18.0	10.0	-	9.174E-05	3.2066	2.1662	0.09	0.667	0.050	from PS sample (.12 mm) + Rip Root value of 3.9 for $c'$
Layer 2	2.59	33.1	3.6	18.0	10.0	-	9.174E-05	3.2066	2.1662	0.29	0.371	0.016	d50 = 0.41 mm + Rip Root value of 3.6 for $c'$
Layer 3	1.92	28.2	18.3	18.0	10.0	-	9.150E-06	1.6788	2.0037	14.45	1.000	0.016	MJ average (new) + Rip Root value of 3.6 for $c'$
Layer 4	1.47	28.2	14.7	18.0	10.0	-	9.150E-06	1.6788	2.0037	0.21	0.436	0.035	d <sub>50</sub> = 0.30 mm

10R Post Restoration													
Material Descriptors		Bank Model Input Data					Groundwater Model Input Data			Toe Model Input Data		Roughness	Comments
Layer Number	Layer Depth	Friction angle $f^a$ (degrees)	Cohesion $c'$ (kPa)	Saturated unit weight (kN/m <sup>3</sup> )	$f^b$ (degrees)	Chemical concentration (kg/kg)	Hydraulic Conductivity $k_{sat}$ (m/s)	van Genuchten $a$ (1/m)	van Genuchten $n$	$\tau_c$ (Pa)	$k$ (cm <sup>3</sup> /Ns)	Manning $n$ (s/m <sup>1/3</sup> )	
Layer 1	1.00	31.0	1.1	18.0	10.0	-	2.823E-05	1.5073	1.8413	3.47	0.581	0.016	Avg. MJ 1 and 2
Layer 2	4.00	31.0	1.1	18.0	10.0	-	2.823E-05	1.5073	1.8413	3.47	0.581	0.016	Avg. MJ 1 and 2
Layer 3	3.03	25.6	15.0	18.0	10.0	-	2.823E-05	1.5073	1.8413	3.47	0.107	0.045	Avg. MJ 1 and 2
Layer 4	1.45	42.0	15.0	20.0	10.0	-	2.823E-05	1.5073	1.8413	57.35	0.026	0.045	Partical Count d <sub>50</sub> = 59 mm

Northfield Mountain Pumped Storage Project (No. 2485) and Turners Falls Hydroelectric Project (No. 1889)

STUDY 3.1.2 NORTHFIELD MOUNTAIN / TURNERS FALLS OPERATIONS IMPACTS ON EXISTING EROSION AND POTENTIAL BANK INSTABILITY

11L													
Material Descriptors		Bank Model Input Data					Groundwater Model Input Data			Toe Model Input Data		Roughness	Comments
Layer Number	Layer Depth	Friction angle $f'$ (degrees)	Cohesion $c'$ (kPa)	Saturated unit weight (kN/m <sup>3</sup> )	$f^b$ (degrees)	Chemical concentration (kg/kg)	Hydraulic Conductivity $k_{sat}$ (m/s)	van Genuchten $a$ (1/m)	van Genuchten $n$	$\tau_c$ (Pa)	$k$ (cm <sup>3</sup> /Ns)	Manning $n$ (s/m <sup>1/3</sup> )	
Layer 1	1.00	33.2	0.4	18.0	10.0	-	9.150E-06	0.6577	1.6788	2.91	0.117	0.030	MJ 3
Layer 2	2.30	33.2	4.4	18.0	10.0	-	9.150E-06	0.6577	1.6788	2.91	0.117	0.050	MJ 3 + Rip Root value of 4.0 for $c'$
Layer 3	4.41	31.8	0.0	18.0	10.0	-	9.150E-06	0.6577	1.6788	2.91	0.117	0.045	MJ 3
Layer 4	0.50	31.8	0.0	18.0	10.0	-	9.150E-06	0.6577	1.6788	4.24	0.097	0.045	Avg. MJ1&2

12BL													
Material Descriptors		Bank Model Input Data					Groundwater Model Input Data			Toe Model Input Data		Roughness	Comments
Layer Number	Layer Depth	Friction angle $f'$ (degrees)	Cohesion $c'$ (kPa)	Saturated unit weight (kN/m <sup>3</sup> )	$f^b$ (degrees)	Chemical concentration (kg/kg)	Hydraulic Conductivity $k_{sat}$ (m/s)	van Genuchten $a$ (1/m)	van Genuchten $n$	$\tau_c$ (Pa)	$k$ (cm <sup>3</sup> /Ns)	Manning $n$ (s/m <sup>1/3</sup> )	
Layer 1	1.00	25.4	4.5	18.0	10.0	-	1.411E-04	4.0563	2.3286	0.08	0.707	0.050	$d_{50} = 0.11$ mm
Layer 2	9.56	31.4	4.7	18.0	10.0	-	9.174E-05	3.2066	2.1662	0.08	0.707	0.035	$d_{50} = 0.11$ mm
Layer 3	4.15	29.2	5.3	18.0	10.0	-	1.411E-04	4.0563	2.3286	0.08	6.500	0.016	$d_{50} = 0.11$ mm
Layer 4	0.85	29.2	5.3	18.0	10.0	-	1.411E-04	4.0563	2.3286	0.16	1.500	0.016	$d_{50} = 0.23$ mm

18L													
Material Descriptors		Bank Model Input Data					Groundwater Model Input Data			Toe Model Input Data		Roughness	Comments
Layer Number	Layer Depth	Friction angle $f'$ (degrees)	Cohesion $c'$ (kPa)	Saturated unit weight (kN/m <sup>3</sup> )	$f^b$ (degrees)	Chemical concentration (kg/kg)	Hydraulic Conductivity $k_{sat}$ (m/s)	van Genuchten $a$ (1/m)	van Genuchten $n$	$\tau_c$ (Pa)	$k$ (cm <sup>3</sup> /Ns)	Manning $n$ (s/m <sup>1/3</sup> )	
Layer 1	1.00	31.0	0.0	18.0	10.0	-	2.823E-05	1.5073	1.8413	2.13	0.137	0.050	MJ 3&4
Layer 2	3.02	31.0	0.0	18.0	10.0	-	2.823E-05	1.5073	1.8413	2.13	0.137	0.050	MJ 3&4
Layer 3	2.00	31.0	0.0	18.0	10.0	-	2.823E-05	1.5073	1.8413	10.24	0.063	0.020	MJ 1&2
Layer 4	1.05	31.0	0.0	18.0	10.0	-	2.823E-05	1.5073	1.8413	0.71	0.270	0.030	assume 1mm sand



Northfield Mountain Pumped Storage Project (No. 2485) and Turners Falls Hydroelectric Project (No. 1889)

STUDY 3.1.2 NORTHFIELD MOUNTAIN / TURNERS FALLS OPERATIONS IMPACTS ON EXISTING EROSION AND POTENTIAL BANK INSTABILITY

21R													
Material Descriptors		Bank Model Input Data					Groundwater Model Input Data			Toe Model Input Data		Roughness	Comments
Layer Number	Layer Depth	Friction angle $f'$ (degrees)	Cohesion $c'$ (kPa)	Saturated unit weight (kN/m <sup>3</sup> )	$f^b$ (degrees)	Chemical concentration (kg/kg)	Hydraulic Conductivity $k_{sat}$ (m/s)	van Genuchten $a$ (1/m)	van Genuchten $n$	$\tau_c$ (Pa)	$k$ (cm <sup>3</sup> /Ns)	Manning $n$ (s/m <sup>1/3</sup> )	
Layer 1	1.00	24.2	18.4	18.0	10.0	-	2.823E-05	1.5073	1.8413	0.96	0.205	0.050	MJ 3&4
Layer 2	2.60	19.8	20.9	18.0	10.0	-	2.823E-05	1.5073	1.8413	0.96	0.205	0.050	MJ 3&4 + Rip Root value of 3.6 for $c'$
Layer 3	3.36	32.8	2.2	18.0	10.0	-	2.823E-05	1.5073	1.8413	0.09	0.670	0.060	MJ 1&2 + Rip Root value of 3.6 for $c'$
Layer 4	1.26	32.8	2.2	18.0	10.0	-	2.823E-05	1.5073	1.8413	0.07	0.756	0.050	$d_{50} = 0.1\text{mm}$

26R													
Material Descriptors		Bank Model Input Data					Groundwater Model Input Data			Toe Model Input Data		Roughness	Comments
Layer Number	Layer Depth	Friction angle $f'$ (degrees)	Cohesion $c'$ (kPa)	Saturated unit weight (kN/m <sup>3</sup> )	$f^b$ (degrees)	Chemical concentration (kg/kg)	Hydraulic Conductivity $k_{sat}$ (m/s)	van Genuchten $a$ (1/m)	van Genuchten $n$	$\tau_c$ (Pa)	$k$ (cm <sup>3</sup> /Ns)	Manning $n$ (s/m <sup>1/3</sup> )	
Layer 1	1.00	31.4	0.0	18.0	10.0	-	9.150E-06	0.6577	1.6788	0.20	0.447	0.040	$d_{50} 0.026\text{mm}-\tau_c*10$ for exposed roots
Layer 2	0.90	31.4	0.0	18.0	10.0	-	9.174E-05	3.2066	2.1662	0.20	0.447	0.050	
Layer 3	5.77	35.4	4.4	18.0	10.0	-	9.174E-05	3.2066	2.1662	0.03	1.212	0.050	MJ 3&4
Layer 4	0.87	35.4	4.4	18.0	10.0	-	9.174E-05	3.2066	2.1662	0.30	0.365	0.050	$d_{50} = 0.42\text{ mm}$

29R													
Material Descriptors		Bank Model Input Data					Groundwater Model Input Data			Toe Model Input Data		Roughness	Comments
Layer Number	Layer Depth	Friction angle $f'$ (degrees)	Cohesion $c'$ (kPa)	Saturated unit weight (kN/m <sup>3</sup> )	$f^b$ (degrees)	Chemical concentration (kg/kg)	Hydraulic Conductivity $k_{sat}$ (m/s)	van Genuchten $a$ (1/m)	van Genuchten $n$	$\tau_c$ (Pa)	$k$ (cm <sup>3</sup> /Ns)	Manning $n$ (s/m <sup>1/3</sup> )	
Layer 1	1.00	31.8	9.1	18.0	10.0	-	2.823E-05	1.5073	1.8413	1.51	0.163	0.050	MJ 3&4
Layer 2	2.00	34.1	0.0	18.0	10.0	-	2.823E-05	1.5073	1.8413	1.51	0.163	0.050	MJ 3&4
Layer 3	4.20	34.1	0.0	18.0	10.0	-	2.823E-05	1.5073	1.8413	2.20	0.135	0.050	MJ 1&2
Layer 4	0.71	34.1	0.0	18.0	10.0	-	2.823E-05	1.5073	1.8413	0.80	0.224	0.050	$d_{50} 0.11\text{ mm}-\tau_c*10$ for exposed roots at water edge

Northfield Mountain Pumped Storage Project (No. 2485) and Turners Falls Hydroelectric Project (No. 1889)

STUDY 3.1.2 NORTHFIELD MOUNTAIN / TURNERS FALLS OPERATIONS IMPACTS ON EXISTING EROSION AND POTENTIAL BANK INSTABILITY

75BL													
Material Descriptors		Bank Model Input Data					Groundwater Model Input Data			Toe Model Input Data		Roughness	Comments
Layer Number	Layer Depth	Friction angle $f^a$ (degrees)	Cohesion $c'$ (kPa)	Saturated unit weight (kN/m <sup>3</sup> )	$f^b$ (degrees)	Chemical concentrat ion (kg/kg)	Hydraulic Conductivity $k_{sat}$ (m/s)	van Genuchten $a$ (1/m)	van Genuchten $n$	$\tau_c$ (Pa)	$k$ (cm <sup>3</sup> /Ns)	Manning $n$ (s/m <sup>1/3</sup> )	
Layer 1	1.00	36.7	1.9	18.0	10.0	-	9.150E-06	0.6577	1.6788	0.11	0.603	0.050	MJ3 MJ3 MJ2 Particle count: D <sub>50</sub> 28.5 mm. Used SP = 0.16 mm based on field observations.
Layer 2	8.82	36.7	1.9	18.0	10.0	-	9.150E-06	0.6577	1.6788	0.11	0.603	0.035	
Layer 3	9.04	33.8	0.0	18.0	10.0	-	2.823E-05	1.5073	1.8413	6.70	0.077	0.035	
Layer 4	0.92	33.8	0.0	18.0	10.0	-	2.823E-05	1.5073	1.8413	0.11	0.603	0.030	
87L													
Material Descriptors		Bank Model Input Data					Groundwater Model Input Data			Toe Model Input Data		Roughness	Comments
Layer Number	Layer Depth	Friction angle $f^a$ (degrees)	Cohesion $c'$ (kPa)	Saturated unit weight (kN/m <sup>3</sup> )	$f^b$ (degrees)	Chemical concentrat ion (kg/kg)	Hydraulic Conductivity $k_{sat}$ (m/s)	van Genuchten $a$ (1/m)	van Genuchten $n$	$\tau_c$ (Pa)	$k$ (cm <sup>3</sup> /Ns)	Manning $n$ (s/m <sup>1/3</sup> )	
Layer 1	1.40	33.1	5.3	18.0	10.0	-	9.150E-06	0.6577	1.6788	0.19	0.455	0.050	MJ 3&4 MJ 3&4 MJ 3&4 MJ 1&2
Layer 2	2.00	27.5	16.2	18.0	10.0	-	9.150E-06	0.6577	1.6788	0.19	0.455	0.050	
Layer 3	2.27	27.5	16.2	18.0	10.0	-	2.823E-05	1.5073	1.8413	0.19	0.455	0.050	
Layer 4	0.53	27.5	16.2	18.0	10.0	-	2.823E-05	1.5073	1.8413	0.07	0.748	0.035	
119BL													
Material Descriptors		Bank Model Input Data					Groundwater Model Input Data			Toe Model Input Data		Roughness	Comments
Layer Number	Layer Depth	Friction angle $f^a$ (degrees)	Cohesion $c'$ (kPa)	Saturated unit weight (kN/m <sup>3</sup> )	$f^b$ (degrees)	Chemical concentrat ion (kg/kg)	Hydraulic Conductivity $k_{sat}$ (m/s)	van Genuchten $a$ (1/m)	van Genuchten $n$	$\tau_c$ (Pa)	$k$ (cm <sup>3</sup> /Ns)	Manning $n$ (s/m <sup>1/3</sup> )	
Layer 1	1.00	35.8	0.0	18.0	10.0	-	9.150E-06	0.6577	1.6788	0.52	0.277	0.050	$\tau_c$ *10 for exposed roots Avg. MJ 3&4 $d_{50} = 0.068$ mm
Layer 2	1.60	35.8	0.0	18.0	10.0	-	9.150E-06	0.6577	1.6788	0.52	0.277	0.040	
Layer 3	4.91	33.0	2.8	18.0	10.0	-	9.150E-06	0.6577	1.6788	0.52	0.277	0.060	
Layer 4	1.15	33.0	2.8	18.0	10.0	-	9.150E-06	0.6577	1.6788	0.26	0.392	0.038	

Northfield Mountain Pumped Storage Project (No. 2485) and Turners Falls Hydroelectric Project (No. 1889)

STUDY 3.1.2 NORTHFIELD MOUNTAIN / TURNERS FALLS OPERATIONS IMPACTS ON EXISTING EROSION AND POTENTIAL BANK INSTABILITY

303BL													
Material Descriptors		Bank Model Input Data					Groundwater Model Input Data			Toe Model Input Data		Roughness	Comments
Layer Number	Layer Depth	Friction angle $f'$ (degrees)	Cohesion $c'$ (kPa)	Saturated unit weight (kN/m <sup>3</sup> )	$f^b$ (degrees)	Chemical concentration (kg/kg)	Hydraulic Conductivity $k_{sat}$ (m/s)	van Genuchten $a$ (1/m)	van Genuchten $n$	$\tau_c$ (Pa)	$k$ (cm <sup>3</sup> /Ns)	Manning $n$ (s/m <sup>1/3</sup> )	
Layer 1	1.10	34.5	0.9	18.0	10.0	-	9.150E-06	0.6577	1.6788	0.14	0.539	0.050	MJ 3&4
Layer 2	1.97	34.5	0.9	18.0	10.0	-	9.150E-06	0.6577	1.6788	0.14	0.539	0.050	MJ 3&4
Layer 3	1.06	34.5	0.9	18.0	10.0	-	9.150E-06	0.6577	1.6788	8.54	0.068	0.060	MJ 1&2
Layer 4	0.86	34.5	0.9	18.0	10.0	-	9.150E-06	0.6577	1.6788	8.54	0.068	0.060	beach $d_{50} = 0.11$ mm

BC1R													
Material Descripti	Bank Model Input Data					Groundwater Model Input Data			Toe Model Input Data		Roughness	Comments	
Layer Number	Friction angle $f'$ (degrees)	Cohesion $c'$ (kPa)	Saturated unit weight (kN/m <sup>3</sup> )	$f^b$ (degrees)	Chemical concentration (kg/kg)	Hydraulic Conductivity $k_{sat}$ (m/s)	van Genuchten $a$ (1/m)	van Genuchten $n$	$\tau_c$ (Pa)	$k$ (cm <sup>3</sup> /Ns)	Manning $n$ (s/m <sup>1/3</sup> )		
Layer 1	32.3	0.4	18.5	10.0	-	1.411E-04	4.0563	2.3286	0.71	0.237	0.040	assume 1mm sand	
Layer 2	14.0	30.6	18.5	10.0	-	1.411E-04	4.0563	2.3286	0.26	2.500	0.020	adj (PS and PC) $d_{50}$ of 0.37mm	
Layer 3	32.3	0.4	18.0	10.0	-	2.820E-06	1.1195	1.5473	0.10	12.920	0.016		
Layer 4	32.3	0.4	18.0	10.0	-	2.820E-06	1.1195	1.5473	0.26	6.325	0.016		

## **APPENDIX M – 2013 FRR RIVERBANK SEGMENTS WITH CAUSES OF EROSION**

2013 FRR Riverbank Segment Attributes - Updated with Causes of Erosion

ID	LENGTH (ft)	BANK	UPPER RIVERBANK				LOWER RIVERBANK			EROSION CHARACTERISTICS							
			SLOPE	HEIGHT	SEDIMENT	VEGETATION	SLOPE	SEDIMENT	VEGETATION	TYPE OF EROSION	POTENTIAL INDICATOR OF EROSION	STAGE OF EROSION	EXTENT OF EROSION	DOMINANT CAUSE	CONTRIBUTING CAUSE	CONTRIBUTING CAUSE 2	LAND-USE POTENTIAL CONTRIBUTING CAUSE
567	690	Right Bank	Flat	Low	Silt/Sand	Heavy	Flat/Beach	Silt/Sand	None-Very Sparse		None	Stable	None/Little	Vernon Operations	High Flows	None	Yes
568	229	Right Bank	Moderate	Low	Silt/Sand	Moderate	Flat/Beach	Silt/Sand	None-Very Sparse		None	Stable	None/Little	Vernon Operations	High Flows	None	Yes
569	120	Right Bank	Flat	Low	Silt/Sand	Heavy	Flat/Beach	Silt/Sand	None-Very Sparse	Undercut	Creep/Leaning Trees	Stable	None/Little	Vernon Operations	High Flows	None	Yes
570	300	Right Bank	Steep	High	Silt/Sand	Heavy	Flat/Beach	Silt/Sand	None-Very Sparse		None	Stable	None/Little	Vernon Operations	High Flows	None	Yes
571	235	Right Bank	Steep	High	Silt/Sand	Moderate	Flat/Beach	Silt/Sand	None-Very Sparse	Rotational Slump	Other	Eroded	Some	Vernon Operations	High Flows	None	Yes
572	594	Right Bank	Steep	High	Silt/Sand	Heavy	Flat/Beach	Silt/Sand	None-Very Sparse		None	Stable	None/Little	Vernon Operations	High Flows	None	Yes
573	387	Right Bank	Moderate	Medium	Silt/Sand	Heavy	Moderate	Silt/Sand	None-Very Sparse		None	Stable	None/Little	Vernon Operations	High Flows	None	Yes
574	184	Right Bank	Moderate	Medium	Silt/Sand	Heavy	Flat/Beach	Gravel	None-Very Sparse		None	Stable	None/Little	Vernon Operations	High Flows	None	Yes
575	233	Right Bank	Moderate	High	Silt/Sand	Heavy	Flat/Beach	Silt/Sand	None-Very Sparse	Undercut	None	Stable	None/Little	Vernon Operations	High Flows	None	No
576	751	Right Bank	Moderate	High	Bedrock	Heavy	Steep	Bedrock	None-Very Sparse		None	Stable	None/Little	Vernon Operations	High Flows	None	No
577	429	Right Bank	Steep	High	Silt/Sand	Heavy	Moderate	Cobbles	None-Very Sparse	Undercut	Creep/Leaning Trees	Stable	None/Little	Vernon Operations	High Flows	None	No
578	322	Right Bank	Steep	High	Bedrock	Moderate	Vertical	Bedrock	None-Very Sparse		None	Stable	None/Little	Vernon Operations	High Flows	None	No
579	696	Right Bank	Moderate	High	Silt/Sand	Heavy	Moderate	Silt/Sand	None-Very Sparse	Undercut	Creep/Leaning Trees	Stable	None/Little	Vernon Operations	High Flows	None	No
580	487	Right Bank	Moderate	High	Bedrock	Moderate	Moderate	Bedrock	None-Very Sparse		None	Stable	None/Little	Vernon Operations	High Flows	None	Yes
581	348	Right Bank	Moderate	High	Silt/Sand	Moderate	Moderate	Boulders	None-Very Sparse	Undercut	None	Stable	None/Little	Vernon Operations	High Flows	None	No
582	328	Right Bank	Moderate	Medium	Bedrock	Moderate	Moderate	Bedrock	None-Very Sparse		None	Stable	None/Little	Vernon Operations	High Flows	None	No
583	127	Right Bank	Moderate	High	Silt/Sand	Heavy	Flat/Beach	Silt/Sand	None-Very Sparse		Creep/Leaning Trees	Stable	None/Little	Vernon Operations	High Flows	None	No
584	52	Right Bank	Moderate	Medium	Bedrock	Heavy	Moderate	Bedrock	None-Very Sparse		None	Stable	None/Little	Vernon Operations	High Flows	None	No
585	157	Right Bank	Moderate	High	Silt/Sand	Heavy	Flat/Beach	Boulders	None-Very Sparse	Undercut	None	Stable	None/Little	Vernon Operations	High Flows	None	No
586	345	Right Bank	Moderate	High	Silt/Sand	Heavy	Moderate	Silt/Sand	None-Very Sparse	Rotational Slump	Overhanging Bank	Eroded	Some	Vernon Operations	High Flows	None	No
587	498	Right Bank	Flat	Low	Silt/Sand	Heavy	Flat/Beach	Silt/Sand	None-Very Sparse	Undercut	Creep/Leaning Trees	Stable	None/Little	Vernon Operations	High Flows	None	No
588	357	Right Bank	Moderate	Medium	Silt/Sand	Moderate	Moderate	Silt/Sand	None-Very Sparse		None	Stable	None/Little	Vernon Operations	High Flows	None	Yes
589	652	Right Bank	Moderate	High	Silt/Sand	Moderate	Moderate	Silt/Sand	None-Very Sparse	Undercut	Creep/Leaning Trees	Stable	None/Little	Vernon Operations	High Flows	None	Yes
590	124	Right Bank	Moderate	Medium	Bedrock	Moderate	Moderate	Bedrock	None-Very Sparse		None	Stable	None/Little	Vernon Operations	High Flows	None	No
591	398	Right Bank	Moderate	Medium	Silt/Sand	Moderate	Flat/Beach	Silt/Sand	None-Very Sparse	Undercut	Creep/Leaning Trees	Stable	None/Little	Vernon Operations	High Flows	None	No

ID	LENGTH (ft)	BANK	UPPER RIVERBANK				LOWER RIVERBANK			EROSION CHARACTERISTICS							
			SLOPE	HEIGHT	SEDIMENT	VEGETATION	SLOPE	SEDIMENT	VEGETATION	TYPE OF EROSION	POTENTIAL INDICATOR OF EROSION	STAGE OF EROSION	EXTENT OF EROSION	DOMINANT CAUSE	CONTRIBUTING CAUSE	CONTRIBUTING CAUSE 2	LAND-USE POTENTIAL CONTRIBUTING CAUSE
592	99	Right Bank	Moderate	Medium	Silt/Sand	Moderate	Flat/Beach	Gravel	None-Very Sparse	Undercut	Creep/Leaning Trees	Stable	None/Little	Vernon Operations	High Flows	None	No
593	97	Right Bank	Moderate	Medium	Silt/Sand	Heavy	Flat/Beach	Silt/Sand	Moderate	Undercut	Creep/Leaning Trees	Stable	None/Little	Vernon Operations	High Flows	None	No
594	429	Right Bank	Moderate	High	Silt/Sand	Heavy	Flat/Beach	Silt/Sand	None-Very Sparse	Undercut	Creep/Leaning Trees	Stable	None/Little	Vernon Operations	High Flows	None	No
595	842	Right Bank	Flat	Medium	Silt/Sand	None-Very Sparse	Flat/Beach	Silt/Sand	None-Very Sparse		None	Stable	None/Little	Vernon Operations	High Flows	None	Yes
596	169	Right Bank	Moderate	High	Boulders	None-Very Sparse	Moderate	Boulders	None-Very Sparse		None	Stable	None/Little	Vernon Operations	High Flows	None	Yes
315	369	Left Bank	Steep	High	Silt/Sand	Heavy	Moderate	Cobbles	None-Very Sparse		None	Stable	None/Little	Vernon Operations	High Flows	None	No
316	502	Left Bank	Steep	High	Silt/Sand	Heavy	Flat/Beach	Gravel	None-Very Sparse		None	Stable	None/Little	Vernon Operations	High Flows	None	No
317	236	Left Bank	Vertical	High	Silt/Sand	Heavy	Flat/Beach	Gravel	None-Very Sparse	Topples	Creep/Leaning Trees	Potential Future Erosion	Some	Vernon Operations	High Flows	None	No
318	841	Left Bank	Steep	High	Silt/Sand	Heavy	Flat/Beach	Silt/Sand	None-Very Sparse	Undercut	Creep/Leaning Trees	Stable	None/Little	Vernon Operations	High Flows	None	No
319	510	Left Bank	Steep	High	Silt/Sand	Heavy	Flat/Beach	Silt/Sand	None-Very Sparse		Creep/Leaning Trees	Stable	None/Little	Vernon Operations	High Flows	None	No
320	252	Left Bank	Moderate	High	Silt/Sand	Heavy	Flat/Beach	Silt/Sand	None-Very Sparse	Undercut	Creep/Leaning Trees	Stable	None/Little	Vernon Operations	High Flows	None	No
321	121	Left Bank	Moderate	High	Silt/Sand	Heavy	Flat/Beach	Silt/Sand	None-Very Sparse	Undercut	None	Stable	None/Little	Vernon Operations	High Flows	None	No
322	350	Left Bank	Moderate	High	Silt/Sand	Heavy	Flat/Beach	Gravel	None-Very Sparse	Undercut	Creep/Leaning Trees	Stable	None/Little	Vernon Operations	High Flows	None	No
323	184	Left Bank	Steep	High	Silt/Sand	Heavy	Moderate	Boulders	None-Very Sparse		Creep/Leaning Trees	Stable	None/Little	Vernon Operations	High Flows	None	Yes
324	284	Left Bank	Moderate	High	Silt/Sand	Heavy	Flat/Beach	Silt/Sand	None-Very Sparse		None	Stable	None/Little	Vernon Operations	High Flows	None	Yes
325	244	Left Bank	Flat	Medium	Silt/Sand	Moderate	Flat/Beach	Silt/Sand	None-Very Sparse		None	Stable	None/Little	Vernon Operations	High Flows	None	Yes
326	174	Left Bank	Moderate	High	Silt/Sand	Heavy	Moderate	Silt/Sand	None-Very Sparse	Undercut	Creep/Leaning Trees	Stable	None/Little	Vernon Operations	High Flows	None	No
327	371	Left Bank	Moderate	High	Silt/Sand	Heavy	Flat/Beach	Silt/Sand	None-Very Sparse	Undercut	Creep/Leaning Trees	Stable	None/Little	Vernon Operations	High Flows	None	No
328	393	Left Bank	Moderate	High	Silt/Sand	Heavy	Flat/Beach	Silt/Sand	Sparse		None	Stable	None/Little	Vernon Operations	High Flows	None	No
329	159	Left Bank	Moderate	High	Silt/Sand	Heavy	Moderate	Silt/Sand	None-Very Sparse		Creep/Leaning Trees	Stable	None/Little	Vernon Operations	High Flows	None	No
330	424	Left Bank	Moderate	High	Silt/Sand	Heavy	Moderate	Silt/Sand	None-Very Sparse	Slide	Creep/Leaning Trees	Eroded	Some	Vernon Operations	High Flows	None	No
331	79	Left Bank	Moderate	High	Silt/Sand	Heavy	Moderate	Cobbles	None-Very Sparse	Slide	None	Stable	None/Little	Vernon Operations	High Flows	None	No
332	89	Left Bank	Moderate	High	Silt/Sand	Moderate	Moderate	Clay	None-Very Sparse	Slide	None	Potential Future Erosion	Some	Vernon Operations	High Flows	None	Yes
333	419	Left Bank	Moderate	High	Silt/Sand	Heavy	Moderate	Silt/Sand	None-Very Sparse		Creep/Leaning Trees	Stable	None/Little	Vernon Operations	High Flows	None	No

ID	LENGTH (ft)	BANK	UPPER RIVERBANK				LOWER RIVERBANK			EROSION CHARACTERISTICS							
			SLOPE	HEIGHT	SEDIMENT	VEGETATION	SLOPE	SEDIMENT	VEGETATION	TYPE OF EROSION	POTENTIAL INDICATOR OF EROSION	STAGE OF EROSION	EXTENT OF EROSION	DOMINANT CAUSE	CONTRIBUTING CAUSE	CONTRIBUTING CAUSE 2	LAND-USE POTENTIAL CONTRIBUTING CAUSE
334	231	Left Bank	Moderate	Low	Silt/Sand	Moderate	Moderate	Silt/Sand	None-Very Sparse		None	Stable	None/Little	Vernon Operations	High Flows	None	No
335	183	Left Bank	Moderate	Low	Silt/Sand	Moderate	Flat/Beach	Gravel	None-Very Sparse	Undercut	Creep/Leaning Trees	Stable	None/Little	Vernon Operations	High Flows	None	No
336	269	Left Bank	Moderate	Low	Silt/Sand	Moderate	Flat/Beach	Silt/Sand	None-Very Sparse		None	Stable	None/Little	Vernon Operations	High Flows	None	No
337	383	Left Bank	Flat	Low	Silt/Sand	Sparse	Flat/Beach	Silt/Sand	None-Very Sparse		None	Stable	None/Little	Vernon Operations	High Flows	None	No
338	393	Left Bank	Flat	Low	Silt/Sand	Moderate	Flat/Beach	Gravel	None-Very Sparse		Creep/Leaning Trees	Stable	None/Little	Vernon Operations	High Flows	None	No
339	149	Left Bank	Flat	Low	Silt/Sand	Moderate	Flat/Beach	Silt/Sand	None-Very Sparse		None	Stable	None/Little	Vernon Operations	High Flows	None	No
340	622	Left Bank	Moderate	High	Bedrock	None-Very Sparse	Steep	Bedrock	None-Very Sparse		None	Stable	None/Little	Vernon Operations	High Flows	None	Yes
341	126	Left Bank	Moderate	High	Boulders	None-Very Sparse	Moderate	Boulders	None-Very Sparse		None	Stable	None/Little	Vernon Operations	High Flows	None	Yes
342	906	Left Bank	Steep	High	Silt/Sand	None-Very Sparse	Flat/Beach	Silt/Sand	None-Very Sparse	Slide	Overhanging Bank	Active Erosion	Extensive	Vernon Operations	High Flows	None	Yes
343	289	Left Bank	Moderate	High	Boulders	None-Very Sparse	Moderate	Boulders	None-Very Sparse		None	Stable	None/Little	Vernon Operations	High Flows	None	Yes
561	550	Right Bank	Steep	Low	Silt/Sand	Moderate	Flat/Beach	Silt/Sand	None-Very Sparse	Undercut	Creep/Leaning Trees	Stable	None/Little	High Flows	None	None	Yes
562	413	Right Bank	Moderate	Medium	Silt/Sand	Heavy	Flat/Beach	Silt/Sand	None-Very Sparse		Creep/Leaning Trees	Stable	None/Little	High Flows	None	None	Yes
563	490	Right Bank	Moderate	High	Silt/Sand	Heavy	Flat/Beach	Silt/Sand	None-Very Sparse		None	Stable	None/Little	High Flows	None	None	Yes
564	229	Right Bank	Moderate	Low	Silt/Sand	Heavy	Flat/Beach	Silt/Sand	None-Very Sparse		None	Stable	None/Little	High Flows	None	None	No
565	502	Right Bank	Moderate	High	Silt/Sand	Heavy	Flat/Beach	Silt/Sand	None-Very Sparse	Undercut	Creep/Leaning Trees	Stable	None/Little	High Flows	None	None	Yes
566	316	Right Bank	Moderate	Low	Silt/Sand	Moderate	Flat/Beach	Silt/Sand	None-Very Sparse		Notching	Stable	None/Little	High Flows	None	None	Yes
305	414	Left Bank	Vertical	High	Silt/Sand	Moderate	Flat/Beach	Silt/Sand	None-Very Sparse	Rotational Slump	Other	Eroded	Some	High Flows	None	None	Yes
306	206	Left Bank	Steep	High	Silt/Sand	Heavy	Flat/Beach	Silt/Sand	None-Very Sparse		None	Stable	None/Little	High Flows	None	None	Yes
307	429	Left Bank	Flat	Low	Silt/Sand	Heavy	Flat/Beach	Silt/Sand	None-Very Sparse		None	Stable	None/Little	High Flows	None	None	Yes
308	75	Left Bank	Vertical	High	Silt/Sand	Moderate	Flat/Beach	Silt/Sand	None-Very Sparse	Slide	Overhanging Bank	Active Erosion	Extensive	High Flows	None	None	Yes
309	263	Left Bank	Steep	High	Silt/Sand	Moderate	Flat/Beach	Silt/Sand	None-Very Sparse	Slide	Creep/Leaning Trees	Eroded	Some	High Flows	None	None	Yes
310	300	Left Bank	Steep	Medium	Silt/Sand	Moderate	Flat/Beach	Silt/Sand	None-Very Sparse		Other	Eroded	Some	High Flows	None	None	No
311	310	Left Bank	Moderate	Low	Silt/Sand	Moderate	Flat/Beach	Silt/Sand	None-Very Sparse	Undercut	Creep/Leaning Trees	Stable	None/Little	High Flows	None	None	No
312	244	Left Bank	Moderate	High	Silt/Sand	Heavy	Flat/Beach	Silt/Sand	None-Very Sparse	Undercut	Creep/Leaning Trees	Stable	None/Little	High Flows	None	None	No
313	653	Left Bank	Moderate	High	Silt/Sand	Moderate	Moderate	Boulders	None-Very Sparse	Undercut	None	Stable	None/Little	High Flows	None	None	No

ID	LENGTH (ft)	BANK	UPPER RIVERBANK				LOWER RIVERBANK			EROSION CHARACTERISTICS							
			SLOPE	HEIGHT	SEDIMENT	VEGETATION	SLOPE	SEDIMENT	VEGETATION	TYPE OF EROSION	POTENTIAL INDICATOR OF EROSION	STAGE OF EROSION	EXTENT OF EROSION	DOMINANT CAUSE	CONTRIBUTING CAUSE	CONTRIBUTING CAUSE 2	LAND-USE POTENTIAL CONTRIBUTING CAUSE
314	408	Left Bank	Steep	High	Silt/Sand	Heavy	Flat/Beach	Silt/Sand	None-Very Sparse	Undercut	None	Stable	None/Little	High Flows	None	None	No
550	359	Right Bank	Moderate	High	Silt/Sand	Heavy	Flat/Beach	Silt/Sand	None-Very Sparse	Undercut	Creep/Leaning Trees	Stable	None/Little	High Flows	None	None	Yes
553	522	Right Bank	Moderate	High	Silt/Sand	Heavy	Flat/Beach	Silt/Sand	None-Very Sparse	Undercut	Creep/Leaning Trees	Stable	None/Little	High Flows	None	None	Yes
554	98	Right Bank	Moderate	High	Silt/Sand	Heavy	Flat/Beach	Silt/Sand	Moderate		None	Stable	None/Little	High Flows	None	None	Yes
555	324	Right Bank	Moderate	High	Silt/Sand	Heavy	Flat/Beach	Silt/Sand	None-Very Sparse		Creep/Leaning Trees	Stable	None/Little	High Flows	None	None	Yes
556	469	Right Bank	Moderate	High	Silt/Sand	Heavy	Flat/Beach	Gravel	None-Very Sparse	Undercut	Creep/Leaning Trees	Stable	None/Little	High Flows	None	None	Yes
557	230	Right Bank	Moderate	High	Silt/Sand	Moderate	Flat/Beach	Silt/Sand	None-Very Sparse	Undercut	Creep/Leaning Trees	Stable	None/Little	High Flows	None	None	No
557	50	Right Bank	Moderate	High	Silt/Sand	Moderate	Flat/Beach	Silt/Sand	None-Very Sparse	Undercut	Creep/Leaning Trees	Stable	None/Little	High Flows	None	None	No
557	972	Right Bank	Moderate	High	Silt/Sand	Moderate	Flat/Beach	Silt/Sand	None-Very Sparse	Undercut	Creep/Leaning Trees	Stable	None/Little	High Flows	None	None	No
558	374	Right Bank	Moderate	High	Silt/Sand	Moderate	Flat/Beach	Silt/Sand	None-Very Sparse		None	Stable	None/Little	High Flows	None	None	No
559	385	Right Bank	Moderate	High	Silt/Sand	Heavy	Flat/Beach	Silt/Sand	None-Very Sparse	Undercut	Creep/Leaning Trees	Stable	None/Little	High Flows	None	None	No
560	533	Right Bank	Flat	Low	Silt/Sand	Moderate	Flat/Beach	Silt/Sand	Moderate		None	Stable	None/Little	High Flows	None	None	Yes
288	351	Left Bank	Moderate	High	Silt/Sand	Heavy	Flat/Beach	Silt/Sand	None-Very Sparse	Undercut	Creep/Leaning Trees	Stable	None/Little	High Flows	None	None	No
289	131	Left Bank	Moderate	High	Silt/Sand	Heavy	Flat/Beach	Silt/Sand	None-Very Sparse		None	Stable	None/Little	High Flows	None	None	No
290	257	Left Bank	Moderate	High	Silt/Sand	Heavy	Flat/Beach	Gravel	None-Very Sparse	Undercut	None	Stable	None/Little	High Flows	None	None	No
291	208	Left Bank	Moderate	High	Silt/Sand	Heavy	Flat/Beach	Gravel	None-Very Sparse	Undercut	Creep/Leaning Trees	Stable	None/Little	High Flows	None	None	No
292	372	Left Bank	Steep	High	Silt/Sand	Heavy	Flat/Beach	Silt/Sand	None-Very Sparse		Creep/Leaning Trees	Stable	None/Little	High Flows	None	None	No
293	160	Left Bank	Moderate	High	Silt/Sand	Heavy	Moderate	Bedrock	None-Very Sparse	Undercut	Creep/Leaning Trees	Stable	None/Little	High Flows	None	None	No
294	226	Left Bank	Moderate	High	Silt/Sand	Heavy	Moderate	Bedrock	None-Very Sparse		None	Stable	None/Little	High Flows	None	None	No
295	145	Left Bank	Moderate	High	Silt/Sand	Heavy	Flat/Beach	Silt/Sand	None-Very Sparse	Undercut	Creep/Leaning Trees	Stable	None/Little	High Flows	None	None	No
296	466	Left Bank	Moderate	High	Silt/Sand	Heavy	Moderate	Bedrock	None-Very Sparse		None	Stable	None/Little	High Flows	None	None	No
297	202	Left Bank	Moderate	High	Silt/Sand	Heavy	Flat/Beach	Silt/Sand	None-Very Sparse	Undercut	Creep/Leaning Trees	Stable	None/Little	High Flows	None	None	No
298	37	Left Bank	Moderate	Low	Silt/Sand	Heavy	Flat/Beach	Silt/Sand	Moderate		None	Stable	None/Little	High Flows	None	None	No
299	416	Left Bank	Moderate	Low	Silt/Sand	Heavy	Flat/Beach	Silt/Sand	None-Very Sparse	Undercut	Creep/Leaning Trees	Stable	None/Little	High Flows	None	None	No
300	958	Left Bank	Moderate	High	Silt/Sand	Heavy	Flat/Beach	Silt/Sand	Moderate		None	Stable	None/Little	High Flows	None	None	Yes
301	145	Left Bank	Moderate	Low	Silt/Sand	Heavy	Flat/Beach	Silt/Sand	None-Very Sparse		None	Stable	None/Little	High Flows	None	None	Yes



ID	LENGTH (ft)	BANK	UPPER RIVERBANK				LOWER RIVERBANK			EROSION CHARACTERISTICS							
			SLOPE	HEIGHT	SEDIMENT	VEGETATION	SLOPE	SEDIMENT	VEGETATION	TYPE OF EROSION	POTENTIAL INDICATOR OF EROSION	STAGE OF EROSION	EXTENT OF EROSION	DOMINANT CAUSE	CONTRIBUTING CAUSE	CONTRIBUTING CAUSE 2	LAND-USE POTENTIAL CONTRIBUTING CAUSE
302	228	Left Bank	Moderate	Low	Silt/Sand	Heavy	Flat/Beach	Silt/Sand	Moderate	Undercut	Creep/Leaning Trees	Stable	None/Little	High Flows	None	None	Yes
303	356	Left Bank	Moderate	Medium	Silt/Sand	Heavy	Flat/Beach	Silt/Sand	Heavy		None	Stable	None/Little	High Flows	None	None	Yes
304	98	Left Bank	Moderate	Medium	Silt/Sand	Heavy	Flat/Beach	Silt/Sand	None-Very Sparse	Undercut	Creep/Leaning Trees	Stable	None/Little	High Flows	None	None	Yes
536	314	Right Bank	Steep	Medium	Silt/Sand	Moderate	Flat/Beach	Silt/Sand	None-Very Sparse	Undercut	Creep/Leaning Trees	Eroded	Some	High Flows	None	None	No
537	273	Right Bank	Moderate	High	Silt/Sand	Moderate	Flat/Beach	Silt/Sand	None-Very Sparse		Creep/Leaning Trees	Eroded	Some	High Flows	None	None	No
538	121	Right Bank	Moderate	High	Silt/Sand	Moderate	Moderate	Bedrock	None-Very Sparse	Undercut	Creep/Leaning Trees	Stable	None/Little	High Flows	None	None	No
539	96	Right Bank	Moderate	High	Silt/Sand	Moderate	Flat/Beach	Silt/Sand	None-Very Sparse		None	Stable	None/Little	High Flows	None	None	No
540	161	Right Bank	Steep	High	Bedrock	Moderate	Steep	Bedrock	None-Very Sparse		None	Stable	None/Little	High Flows	None	None	Yes
541	588	Right Bank	Moderate	High	Silt/Sand	Moderate	Flat/Beach	Silt/Sand	None-Very Sparse		Creep/Leaning Trees	Stable	None/Little	High Flows	None	None	No
542	1338	Right Bank	Moderate	High	Silt/Sand	Heavy	Flat/Beach	Silt/Sand	None-Very Sparse		Creep/Leaning Trees	Stable	None/Little	High Flows	None	None	Yes
543	845	Right Bank	Moderate	High	Silt/Sand	Moderate	Flat/Beach	Silt/Sand	None-Very Sparse	Undercut	Creep/Leaning Trees	Stable	None/Little	High Flows	None	None	Yes
544	403	Right Bank	Moderate	High	Silt/Sand	Moderate	Flat/Beach	Silt/Sand	None-Very Sparse		Creep/Leaning Trees	Stable	None/Little	High Flows	None	None	Yes
545	263	Right Bank	Moderate	Medium	Silt/Sand	Moderate	Flat/Beach	Silt/Sand	None-Very Sparse		Notching	Stable	None/Little	High Flows	None	None	No
546	331	Right Bank	Moderate	Low	Silt/Sand	Moderate	Flat/Beach	Silt/Sand	None-Very Sparse		None	Stable	None/Little	High Flows	None	None	Yes
547	1002	Right Bank	Moderate	Medium	Silt/Sand	Moderate	Flat/Beach	Silt/Sand	None-Very Sparse		None	Stable	None/Little	High Flows	None	None	Yes
548	910	Right Bank	Moderate	High	Silt/Sand	Heavy	Flat/Beach	Silt/Sand	None-Very Sparse		None	Stable	None/Little	High Flows	None	None	Yes
549	503	Right Bank	Flat	High	Silt/Sand	Heavy	Flat/Beach	Silt/Sand	None-Very Sparse		None	Stable	None/Little	High Flows	None	None	Yes
267	262	Left Bank	Moderate	High	Silt/Sand	Moderate	Flat/Beach	Silt/Sand	Sparse		Notching	Stable	None/Little	High Flows	None	None	Yes
268	213	Left Bank	Steep	High	Silt/Sand	Heavy	Flat/Beach	Silt/Sand	None-Very Sparse		None	Stable	None/Little	High Flows	None	None	Yes
269	96	Left Bank	Steep	High	Silt/Sand	Heavy	Flat/Beach	Silt/Sand	Sparse		None	Stable	None/Little	High Flows	None	None	Yes
270	223	Left Bank	Steep	High	Silt/Sand	Heavy	Flat/Beach	Silt/Sand	None-Very Sparse		None	Stable	None/Little	High Flows	None	None	No
271	124	Left Bank	Steep	High	Silt/Sand	Heavy	Flat/Beach	Silt/Sand	None-Very Sparse	Undercut	Creep/Leaning Trees	Potential Future Erosion	Some	High Flows	None	None	No
272	76	Left Bank	Steep	High	Silt/Sand	Moderate	Flat/Beach	Silt/Sand	None-Very Sparse	Slide	Overhanging Bank	Eroded	Some	High Flows	None	None	No
273	98	Left Bank	Steep	High	Silt/Sand	Heavy	Flat/Beach	Silt/Sand	None-Very Sparse		None	Stable	None/Little	High Flows	None	None	No
274	330	Left Bank	Vertical	High	Silt/Sand	Moderate	Flat/Beach	Silt/Sand	None-Very Sparse	Topples	Overhanging Bank	Eroded	Some	High Flows	None	None	No

ID	LENGTH (ft)	BANK	UPPER RIVERBANK				LOWER RIVERBANK			EROSION CHARACTERISTICS							
			SLOPE	HEIGHT	SEDIMENT	VEGETATION	SLOPE	SEDIMENT	VEGETATION	TYPE OF EROSION	POTENTIAL INDICATOR OF EROSION	STAGE OF EROSION	EXTENT OF EROSION	DOMINANT CAUSE	CONTRIBUTING CAUSE	CONTRIBUTING CAUSE 2	LAND-USE POTENTIAL CONTRIBUTING CAUSE
275	163	Left Bank	Steep	High	Silt/Sand	Heavy	Flat/Beach	Silt/Sand	None-Very Sparse	Undercut	Creep/Leaning Trees	Stable	None/Little	High Flows	None	None	No
276	964	Left Bank	Steep	High	Silt/Sand	Moderate	Flat/Beach	Gravel	None-Very Sparse	Undercut	Creep/Leaning Trees	Stable	None/Little	High Flows	None	None	No
277	50	Left Bank	Steep	High	Silt/Sand	Moderate	Flat/Beach	Gravel	Sparse	Undercut	Creep/Leaning Trees	Stable	None/Little	High Flows	None	None	No
278	514	Left Bank	Steep	High	Silt/Sand	Heavy	Flat/Beach	Gravel	None-Very Sparse	Undercut	Creep/Leaning Trees	Stable	None/Little	High Flows	None	None	No
279	111	Left Bank	Steep	High	Silt/Sand	Heavy	Flat/Beach	Gravel	Sparse	Undercut	Creep/Leaning Trees	Stable	None/Little	High Flows	None	None	No
280	1169	Left Bank	Steep	High	Silt/Sand	Heavy	Flat/Beach	Silt/Sand			None	Stable	None/Little	High Flows	None	None	No
281	209	Left Bank	Steep	High	Silt/Sand	Moderate	Flat/Beach	Silt/Sand	None-Very Sparse	Undercut	Creep/Leaning Trees	Eroded	Some	High Flows	None	None	No
282	663	Left Bank	Moderate	High	Silt/Sand	Heavy	Flat/Beach	Silt/Sand	None-Very Sparse	Undercut	Creep/Leaning Trees	Stable	None/Little	High Flows	None	None	No
283	82	Left Bank	Steep	High	Silt/Sand	Moderate	Flat/Beach	Silt/Sand	None-Very Sparse	Rotational Slump	Creep/Leaning Trees	Eroded	Some	High Flows	None	None	No
284	870	Left Bank	Moderate	High	Silt/Sand	Heavy	Flat/Beach	Silt/Sand	None-Very Sparse	Undercut	Creep/Leaning Trees	Stable	None/Little	High Flows	None	None	No
285	211	Left Bank	Moderate	High	Silt/Sand	Heavy	Flat/Beach	Gravel	None-Very Sparse	Undercut	Creep/Leaning Trees	Stable	None/Little	High Flows	None	None	No
286	36	Left Bank	Steep	High	Silt/Sand	Moderate	Flat/Beach	Gravel	None-Very Sparse	Topples	Creep/Leaning Trees	Eroded	Some	High Flows	None	None	No
287	103	Left Bank	Steep	High	Silt/Sand	Heavy	Flat/Beach	Gravel	None-Very Sparse		None	Stable	None/Little	High Flows	None	None	No
523	239	Right Bank	Steep	High	Silt/Sand	Heavy	Flat/Beach	Silt/Sand	None-Very Sparse	Undercut	Creep/Leaning Trees	Stable	None/Little	High Flows	None	None	Yes
524	70	Right Bank	Steep	High	Silt/Sand	Heavy	Flat/Beach	Silt/Sand	None-Very Sparse	Topples	Creep/Leaning Trees	Eroded	Some	High Flows	None	None	Yes
525	737	Right Bank	Moderate	High	Silt/Sand	Heavy	Moderate	Cobbles	None-Very Sparse		None	Stable	None/Little	High Flows	None	None	Yes
526	134	Right Bank	Steep	High	Silt/Sand	Heavy	Moderate	Boulders	None-Very Sparse		Creep/Leaning Trees	Stable	None/Little	High Flows	None	None	Yes
527	36	Right Bank						Bedrock						High Flows	None	None	Yes
528	108	Right Bank	Moderate	High	Silt/Sand	Moderate	Moderate	Boulders	None-Very Sparse		Creep/Leaning Trees	Stable	None/Little	High Flows	None	None	Yes
529	199	Right Bank	Steep	High	Silt/Sand	Moderate	Flat/Beach	Silt/Sand	None-Very Sparse	Undercut	Creep/Leaning Trees	Stable	None/Little	High Flows	None	None	Yes
530	277	Right Bank	Moderate	High	Silt/Sand	Heavy	Flat/Beach	Gravel	None-Very Sparse	Undercut	Creep/Leaning Trees	Stable	None/Little	High Flows	None	None	Yes
531	376	Right Bank	Moderate	High	Silt/Sand	Moderate	Flat/Beach	Silt/Sand	None-Very Sparse	Undercut	Creep/Leaning Trees	Stable	None/Little	High Flows	None	None	No
532	212	Right Bank	Moderate	High	Silt/Sand	Moderate	Flat/Beach	Silt/Sand	None-Very Sparse		Creep/Leaning Trees	Stable	None/Little	High Flows	None	None	No
533	766	Right Bank	Moderate	High	Silt/Sand	Heavy	Flat/Beach	Silt/Sand	None-Very Sparse	Undercut	Creep/Leaning Trees	Stable	None/Little	High Flows	None	None	No
534	191	Right Bank	Moderate	High	Silt/Sand	Heavy	Moderate	Silt/Sand	None-Very Sparse		Creep/Leaning Trees	Stable	None/Little	High Flows	None	None	No

ID	LENGTH (ft)	BANK	UPPER RIVERBANK				LOWER RIVERBANK			EROSION CHARACTERISTICS							
			SLOPE	HEIGHT	SEDIMENT	VEGETATION	SLOPE	SEDIMENT	VEGETATION	TYPE OF EROSION	POTENTIAL INDICATOR OF EROSION	STAGE OF EROSION	EXTENT OF EROSION	DOMINANT CAUSE	CONTRIBUTING CAUSE	CONTRIBUTING CAUSE 2	LAND-USE POTENTIAL CONTRIBUTING CAUSE
535	407	Right Bank	Moderate	High	Silt/Sand	Moderate	Moderate	Bedrock	None-Very Sparse		None	Stable	None/Little	High Flows	None	None	No
248	155	Left Bank	Steep	High	Silt/Sand	Moderate	Flat/Beach	Silt/Sand	None-Very Sparse	Slide	Overhanging Bank	Eroded	Some	High Flows	None	None	No
249	430	Left Bank	Moderate	High	Silt/Sand	Heavy	Flat/Beach	Silt/Sand	None-Very Sparse	Undercut	Creep/Leaning Trees	Stable	None/Little	High Flows	None	None	No
250	143	Left Bank	Overhanging	High	Silt/Sand	Moderate	Flat/Beach	Silt/Sand	None-Very Sparse	Slide	Overhanging Bank	Eroded	Some	High Flows	None	None	No
251	193	Left Bank	Steep	High	Silt/Sand	Heavy	Flat/Beach	Silt/Sand	None-Very Sparse		Creep/Leaning Trees	Stable	None/Little	High Flows	None	None	No
252	32	Left Bank	Vertical	High	Bedrock	None-Very Sparse	Vertical	Bedrock	None-Very Sparse		None	Stable	None/Little	High Flows	None	None	No
253	218	Left Bank	Steep	High	Silt/Sand	Moderate	Moderate	Boulders	None-Very Sparse		None	Stable	None/Little	High Flows	None	None	No
254	173	Left Bank	Moderate	Low	Silt/Sand	Heavy	Flat/Beach	Silt/Sand	None-Very Sparse		None	Stable	None/Little	High Flows	None	None	Yes
255	188	Left Bank	Moderate	High	Silt/Sand	Moderate	Flat/Beach	Silt/Sand	None-Very Sparse		Notching	Stable	None/Little	High Flows	None	None	Yes
256	58	Left Bank	Steep	High	Silt/Sand	Moderate	Flat/Beach	Silt/Sand	Sparse	Slide	Notching	Eroded	Some	High Flows	None	None	Yes
257	83	Left Bank	Steep	High	Silt/Sand	Heavy	Flat/Beach	Silt/Sand	None-Very Sparse		Creep/Leaning Trees	Stable	None/Little	High Flows	None	None	Yes
258	136	Left Bank	Steep	High	Silt/Sand	Moderate	Flat/Beach	Silt/Sand	None-Very Sparse	Slide	Creep/Leaning Trees	Eroded	Some	High Flows	None	None	Yes
259	102	Left Bank	Steep	High	Silt/Sand	Heavy	Flat/Beach	Silt/Sand	None-Very Sparse	Undercut	Creep/Leaning Trees	Stable	None/Little	High Flows	None	None	Yes
260	336	Left Bank	Steep	High	Silt/Sand	Moderate	Flat/Beach	Boulders	None-Very Sparse	Slide	Creep/Leaning Trees	Eroded	Some	High Flows	None	None	Yes
261	502	Left Bank	Steep	High	Silt/Sand	Moderate	Flat/Beach	Gravel	None-Very Sparse	Slide	Creep/Leaning Trees	Potential Future Erosion	Some	High Flows	None	None	Yes
262	157	Left Bank	Steep	High	Silt/Sand	Heavy	Flat/Beach	Silt/Sand	None-Very Sparse		None	Potential Future Erosion	Some	High Flows	None	None	Yes
263	54	Left Bank	Vertical	High	Silt/Sand	Sparse	Flat/Beach	Silt/Sand	None-Very Sparse	Slide	Other	Eroded	Some	High Flows	None	None	Yes
264	333	Left Bank	Steep	High	Silt/Sand	Heavy	Flat/Beach	Silt/Sand	None-Very Sparse		Creep/Leaning Trees	Potential Future Erosion	Some	High Flows	None	None	Yes
265	54	Left Bank	Moderate	High	Silt/Sand	Heavy	Flat/Beach	Silt/Sand	Moderate		None	Stable	None/Little	High Flows	None	None	Yes
266	150	Left Bank	Moderate	High	Silt/Sand	Heavy	Flat/Beach	Silt/Sand	None-Very Sparse		None	Stable	None/Little	High Flows	None	None	Yes
517	624	Right Bank	Steep	High	Silt/Sand	Heavy	Flat/Beach	Silt/Sand	Sparse		Creep/Leaning Trees	Stable	None/Little	High Flows	None	None	Yes
518	173	Right Bank	Steep	High	Silt/Sand	Heavy	Flat/Beach	Silt/Sand	None-Very Sparse	Undercut	Creep/Leaning Trees	Stable	None/Little	High Flows	None	None	Yes
519	215	Right Bank	Steep	High	Silt/Sand	Heavy	Flat/Beach	Silt/Sand	Moderate		None	Stable	None/Little	High Flows	None	None	Yes
520	623	Right Bank	Steep	High	Silt/Sand	Heavy	Flat/Beach	Silt/Sand	None-Very Sparse	Undercut	Creep/Leaning Trees	Stable	None/Little	High Flows	None	None	Yes

ID	LENGTH (ft)	BANK	UPPER RIVERBANK				LOWER RIVERBANK			EROSION CHARACTERISTICS							
			SLOPE	HEIGHT	SEDIMENT	VEGETATION	SLOPE	SEDIMENT	VEGETATION	TYPE OF EROSION	POTENTIAL INDICATOR OF EROSION	STAGE OF EROSION	EXTENT OF EROSION	DOMINANT CAUSE	CONTRIBUTING CAUSE	CONTRIBUTING CAUSE 2	LAND-USE POTENTIAL CONTRIBUTING CAUSE
521	1480	Right Bank	Steep	High	Silt/Sand	Heavy	Flat/Beach	Silt/Sand	None-Very Sparse	Undercut	Creep/Leaning Trees	Stable	None/Little	High Flows	None	None	Yes
522	277	Right Bank	Steep	High	Silt/Sand	Heavy	Flat/Beach	Silt/Sand	None-Very Sparse	Undercut	Overhanging Bank	Eroded	Some	High Flows	None	None	Yes
242	138	Left Bank	Steep	Low	Silt/Sand	Heavy	Flat/Beach	Silt/Sand	None-Very Sparse	Undercut	Creep/Leaning Trees	Potential Future Erosion	Some	High Flows	None	None	No
243	68	Left Bank	Vertical	Low	Silt/Sand	Moderate	Flat/Beach	Silt/Sand	None-Very Sparse	Topples	Creep/Leaning Trees	Eroded	Some	High Flows	None	None	No
244	377	Left Bank	Steep	Low	Silt/Sand	Heavy	Flat/Beach	Silt/Sand	None-Very Sparse	Undercut	Creep/Leaning Trees	Potential Future Erosion	Some	High Flows	None	None	Yes
245	628	Left Bank	Steep	High	Silt/Sand	Heavy	Flat/Beach	Silt/Sand	None-Very Sparse	Undercut	Creep/Leaning Trees	Potential Future Erosion	Some	High Flows	None	None	Yes
246	2056	Left Bank	Moderate	High	Silt/Sand	Heavy	Flat/Beach	Silt/Sand	None-Very Sparse	Undercut	Creep/Leaning Trees	Potential Future Erosion	Some	High Flows	None	None	No
247	933	Left Bank	Moderate	Low	Silt/Sand	Heavy	Flat/Beach	Silt/Sand	None-Very Sparse	Undercut	Creep/Leaning Trees	Potential Future Erosion	Some	High Flows	None	None	Yes
442	816	Right Bank	Steep	High	Silt/Sand	Heavy	Flat/Beach	Silt/Sand	Heavy		None	Stable	None/Little	High Flows	None	None	Yes
443	580	Right Bank	Moderate	High	Silt/Sand	Heavy	Moderate	Cobbles	None-Very Sparse		None	Stable	None/Little	High Flows	None	None	Yes
444	459	Right Bank	Steep	High	Silt/Sand	Heavy	Flat/Beach	Silt/Sand	Heavy		None	Stable	None/Little	High Flows	None	None	Yes
445	51	Right Bank	Steep	High	Silt/Sand	Heavy	Flat/Beach	Silt/Sand	None-Very Sparse	Undercut	Creep/Leaning Trees	Stable	None/Little	High Flows	None	None	Yes
446	428	Right Bank	Overhanging	High	Silt/Sand	Moderate	Flat/Beach	Silt/Sand	None-Very Sparse	Undercut	Creep/Leaning Trees	Eroded	Some	High Flows	None	None	Yes
447	1045	Right Bank	Steep	High	Silt/Sand	Heavy	Flat/Beach	Silt/Sand	None-Very Sparse	Undercut	Creep/Leaning Trees	Potential Future Erosion	Some	High Flows	None	None	No
448	432	Right Bank	Moderate	High	Silt/Sand	Heavy	Moderate	Boulders	None-Very Sparse		None	Stable	None/Little	High Flows	None	None	Yes
449	177	Right Bank	Moderate	High	Silt/Sand	Moderate	Flat/Beach	Silt/Sand	None-Very Sparse	Rotational Slump	Creep/Leaning Trees	Eroded	Some	High Flows	None	None	Yes
450	411	Right Bank	Moderate	High	Silt/Sand	Heavy	Flat/Beach	Silt/Sand	None-Very Sparse	Undercut	Creep/Leaning Trees	Stable	None/Little	High Flows	None	None	Yes
451	1086	Right Bank	Moderate	High	Silt/Sand	Heavy	Flat/Beach	Gravel	None-Very Sparse		None	Stable	None/Little	High Flows	None	None	Yes
452	68	Right Bank	Moderate	High	Silt/Sand	Heavy	Flat/Beach	Silt/Sand	None-Very Sparse	Undercut	Creep/Leaning Trees	Stable	None/Little	High Flows	None	None	No
453	432	Right Bank	Moderate	Low	Silt/Sand	Heavy	Flat/Beach	Silt/Sand	None-Very Sparse	Undercut	Creep/Leaning Trees	Stable	None/Little	High Flows	None	None	No
454	1286	Right Bank	Moderate	High	Silt/Sand	Heavy	Moderate	Cobbles	Sparse		None	Stable	None/Little	High Flows	None	None	Yes
455	838	Right Bank	Steep	High	Silt/Sand	Heavy	Flat/Beach	Silt/Sand	None-Very Sparse	Planar Slip	Creep/Leaning Trees	Eroded	Some	High Flows	None	None	No
456	284	Right Bank	Moderate	High	Silt/Sand	Heavy	Flat/Beach	Silt/Sand	None-Very Sparse	Undercut	Creep/Leaning Trees	Stable	None/Little	High Flows	None	None	No

ID	LENGTH (ft)	BANK	UPPER RIVERBANK				LOWER RIVERBANK			EROSION CHARACTERISTICS							
			SLOPE	HEIGHT	SEDIMENT	VEGETATION	SLOPE	SEDIMENT	VEGETATION	TYPE OF EROSION	POTENTIAL INDICATOR OF EROSION	STAGE OF EROSION	EXTENT OF EROSION	DOMINANT CAUSE	CONTRIBUTING CAUSE	CONTRIBUTING CAUSE 2	LAND-USE POTENTIAL CONTRIBUTING CAUSE
457	59	Right Bank	Moderate	High	Silt/Sand	Heavy	Moderate	Cobbles	None-Very Sparse	Undercut	Creep/Leaning Trees	Potential Future Erosion	Some	High Flows	None	None	No
458	336	Right Bank	Moderate	High	Silt/Sand	Heavy	Flat/Beach	Silt/Sand	None-Very Sparse	Undercut	Creep/Leaning Trees	Stable	None/Little	High Flows	None	None	No
459	164	Right Bank	Moderate	High	Silt/Sand	Heavy	Flat/Beach	Gravel	None-Very Sparse	Undercut	None	Stable	None/Little	High Flows	None	None	No
460	876	Right Bank	Moderate	High	Silt/Sand	Heavy	Flat/Beach	Silt/Sand	None-Very Sparse	Undercut	Creep/Leaning Trees	Stable	None/Little	High Flows	None	None	No
461	113	Right Bank	Moderate	Low	Silt/Sand	Heavy	Moderate	Boulders	None-Very Sparse	Undercut	None	Stable	None/Little	High Flows	None	None	Yes
462	144	Right Bank	Moderate	High	Silt/Sand	Heavy	Flat/Beach	Silt/Sand	None-Very Sparse	Undercut	None	Stable	None/Little	High Flows	None	None	No
463	162	Right Bank	Moderate	Low	Silt/Sand	Heavy	Flat/Beach	Bedrock	None-Very Sparse		None	Stable	None/Little	High Flows	None	None	No
464	369	Right Bank	Moderate	High	Silt/Sand	Heavy	Flat/Beach	Silt/Sand	None-Very Sparse		Creep/Leaning Trees	Stable	None/Little	High Flows	None	None	No
465	1269	Right Bank	Moderate	Low	Silt/Sand	Heavy	Flat/Beach	Silt/Sand	Moderate		None	Stable	None/Little	High Flows	None	None	No
466	568	Right Bank	Moderate	Medium	Silt/Sand	Heavy	Flat/Beach	Silt/Sand	None-Very Sparse		Creep/Leaning Trees	Potential Future Erosion	Some	High Flows	None	None	Yes
467	992	Right Bank	Steep	High	Silt/Sand	Heavy	Flat/Beach	Silt/Sand	None-Very Sparse	Undercut	Creep/Leaning Trees	Potential Future Erosion	Some	High Flows	None	None	Yes
468	252	Right Bank	Steep	High	Silt/Sand	Heavy	Flat/Beach	Silt/Sand	None-Very Sparse	Slide	Overhanging Bank	Eroded	Some	High Flows	None	None	Yes
469	54	Right Bank	Steep	High	Silt/Sand	Heavy	Flat/Beach	Silt/Sand	None-Very Sparse	Topples	Creep/Leaning Trees	Eroded	Some	High Flows	None	None	No
470	173	Right Bank	Overhanging	High	Silt/Sand	Heavy	Flat/Beach	Silt/Sand	None-Very Sparse	Slide	Overhanging Bank	Eroded	Some	High Flows	None	None	No
471	184	Right Bank	Steep	High	Silt/Sand	Heavy	Flat/Beach	Cobbles	None-Very Sparse	Undercut	Creep/Leaning Trees	Stable	None/Little	High Flows	None	None	No
472	65	Right Bank	Steep	High	Silt/Sand	Heavy	Flat/Beach	Silt/Sand	None-Very Sparse		None	Eroded	Some	High Flows	None	None	No
473	64	Right Bank	Steep	Low	Silt/Sand	Heavy	Flat/Beach	Silt/Sand	None-Very Sparse	Undercut	Creep/Leaning Trees	Stable	None/Little	High Flows	None	None	No
474	105	Right Bank	Steep	High	Silt/Sand	Heavy	Flat/Beach	Silt/Sand	None-Very Sparse	Undercut	Creep/Leaning Trees	Potential Future Erosion	Some	High Flows	None	None	No
475	76	Right Bank	Steep	High	Silt/Sand	Heavy	Flat/Beach	Silt/Sand	None-Very Sparse		Creep/Leaning Trees	Eroded	Some	High Flows	None	None	No
476	124	Right Bank	Steep	High	Silt/Sand	Heavy	Flat/Beach	Silt/Sand	None-Very Sparse		None	Potential Future Erosion	None/Little	High Flows	None	None	No
477	152	Right Bank	Steep	High	Silt/Sand	Heavy	Flat/Beach	Silt/Sand	None-Very Sparse		None	Potential Future Erosion	None/Little	High Flows	None	None	No
478	1113	Right Bank	Steep	High	Silt/Sand	Moderate	Flat/Beach	Silt/Sand	None-Very Sparse	Slide	Overhanging Bank	Eroded	Some	High Flows	None	None	Yes

ID	LENGTH (ft)	BANK	UPPER RIVERBANK				LOWER RIVERBANK			EROSION CHARACTERISTICS							
			SLOPE	HEIGHT	SEDIMENT	VEGETATION	SLOPE	SEDIMENT	VEGETATION	TYPE OF EROSION	POTENTIAL INDICATOR OF EROSION	STAGE OF EROSION	EXTENT OF EROSION	DOMINANT CAUSE	CONTRIBUTING CAUSE	CONTRIBUTING CAUSE 2	LAND-USE POTENTIAL CONTRIBUTING CAUSE
479	125	Right Bank	Steep	High	Silt/Sand	Heavy	Flat/Beach	Silt/Sand	None-Very Sparse		Creep/Leaning Trees	Stable	None/Little	High Flows	None	None	Yes
480	77	Right Bank	Steep	High	Silt/Sand	Moderate	Flat/Beach	Silt/Sand	None-Very Sparse	Slide	Exposed Roots	Eroded	Some	High Flows	None	None	Yes
481	39	Right Bank	Steep	High	Silt/Sand	Heavy	Flat/Beach	Silt/Sand	None-Very Sparse		None	Stable	None/Little	High Flows	None	None	Yes
482	109	Right Bank	Overhanging	High	Silt/Sand	Moderate	Flat/Beach	Silt/Sand	None-Very Sparse	Slide	Overhanging Bank	Eroded	Some	High Flows	None	None	Yes
483	52	Right Bank	Moderate	High	Silt/Sand	Heavy	Moderate	Boulders	None-Very Sparse		None	Stable	None/Little	High Flows	None	None	Yes
484	86	Right Bank						Bedrock						High Flows	None	None	Yes
485	579	Right Bank	Moderate	High	Silt/Sand	Heavy	Moderate	Cobbles	None-Very Sparse		None	Stable	None/Little	High Flows	None	None	Yes
486	30	Right Bank	Flat	Low	Silt/Sand	Heavy	Flat/Beach	Bedrock	None-Very Sparse		None	Stable	None/Little	High Flows	None	None	No
487	125	Right Bank	Moderate	Low	Silt/Sand	Heavy	Moderate	Cobbles	None-Very Sparse		None	Stable	None/Little	High Flows	None	None	No
488	121	Right Bank	Moderate	Low	Silt/Sand	Heavy	Moderate	Bedrock	None-Very Sparse		None	Stable	None/Little	High Flows	None	None	No
489	253	Right Bank	Moderate	High	Silt/Sand	Heavy	Moderate	Boulders	None-Very Sparse		None	Stable	None/Little	High Flows	None	None	No
490	100	Right Bank	Steep	High	Silt/Sand	Moderate	Flat/Beach	Silt/Sand	None-Very Sparse		None	Stable	None/Little	High Flows	None	None	No
491	1806	Right Bank	Moderate	High	Silt/Sand	Heavy	Flat/Beach	Silt/Sand	None-Very Sparse	Undercut	Creep/Leaning Trees	Stable	None/Little	High Flows	None	None	No
492	632	Right Bank	Moderate	High	Silt/Sand	Heavy	Flat/Beach	Silt/Sand	None-Very Sparse	Undercut	Creep/Leaning Trees	Stable	None/Little	High Flows	None	None	No
493	71	Right Bank	Steep	High	Silt/Sand	Heavy	Flat/Beach	Silt/Sand	None-Very Sparse	Topples	Creep/Leaning Trees	Eroded	Some	High Flows	None	None	No
494	76	Right Bank	Moderate	High	Silt/Sand	Heavy	Flat/Beach	Silt/Sand	None-Very Sparse	Undercut	None	Potential Future Erosion	Some	High Flows	None	None	No
495	695	Right Bank	Moderate	High	Silt/Sand	Heavy	Flat/Beach	Cobbles	None-Very Sparse	Undercut	Creep/Leaning Trees	Stable	None/Little	High Flows	None	None	No
496	46	Right Bank	Steep	High	Silt/Sand	Heavy	Flat/Beach	Cobbles	None-Very Sparse	Slide	Creep/Leaning Trees	Eroded	Some	High Flows	None	None	No
497	331	Right Bank	Moderate	High	Silt/Sand	Heavy	Flat/Beach	Gravel	None-Very Sparse		None	Stable	None/Little	High Flows	None	None	No
498	657	Right Bank	Moderate	High	Silt/Sand	Heavy	Flat/Beach	Silt/Sand	None-Very Sparse	Undercut	Creep/Leaning Trees	Stable	None/Little	High Flows	None	None	No
499	2435	Right Bank	Moderate	High	Silt/Sand	Heavy	Flat/Beach	Silt/Sand	None-Very Sparse	Undercut	Creep/Leaning Trees	Stable	None/Little	High Flows	None	None	No
500	333	Right Bank	Moderate	High	Silt/Sand	Heavy	Moderate	Cobbles	None-Very Sparse		None	Stable	None/Little	High Flows	None	None	Yes
501	906	Right Bank	Steep	High	Silt/Sand	Heavy	Flat/Beach	Silt/Sand	None-Very Sparse	Undercut	Creep/Leaning Trees	Stable	None/Little	High Flows	None	None	Yes
502	104	Right Bank	Steep	High	Silt/Sand	Moderate	Flat/Beach	Silt/Sand	None-Very Sparse	Slide	Creep/Leaning Trees	Eroded	Some	High Flows	None	None	No
503	247	Right Bank	Steep	High	Silt/Sand	Heavy	Flat/Beach	Silt/Sand	None-Very Sparse	Undercut	Creep/Leaning Trees	Stable	None/Little	High Flows	None	None	Yes

ID	LENGTH (ft)	BANK	UPPER RIVERBANK				LOWER RIVERBANK			EROSION CHARACTERISTICS							
			SLOPE	HEIGHT	SEDIMENT	VEGETATION	SLOPE	SEDIMENT	VEGETATION	TYPE OF EROSION	POTENTIAL INDICATOR OF EROSION	STAGE OF EROSION	EXTENT OF EROSION	DOMINANT CAUSE	CONTRIBUTING CAUSE	CONTRIBUTING CAUSE 2	LAND-USE POTENTIAL CONTRIBUTING CAUSE
504	213	Right Bank	Steep	High	Silt/Sand	Heavy	Flat/Beach	Silt/Sand	None-Very Sparse	Undercut	Creep/Leaning Trees	Eroded	Some	High Flows	None	None	Yes
505	221	Right Bank	Steep	High	Silt/Sand	Heavy	Moderate	Boulders	None-Very Sparse		Creep/Leaning Trees	Stable	None/Little	High Flows	None	None	Yes
506	495	Right Bank	Steep	High	Silt/Sand	Heavy	Moderate	Cobbles	None-Very Sparse		None	Stable	None/Little	High Flows	None	None	No
507	45	Right Bank						Bedrock						High Flows	None	None	Yes
508	67	Right Bank	Steep	High	Silt/Sand	Heavy	Moderate	Cobbles	None-Very Sparse		None	Stable	None/Little	High Flows	None	None	Yes
509	1813	Right Bank	Steep	High	Silt/Sand	Heavy	Flat/Beach	Silt/Sand	None-Very Sparse	Undercut	Creep/Leaning Trees	Stable	None/Little	High Flows	None	None	Yes
510	388	Right Bank	Steep	Low	Silt/Sand	Heavy	Flat/Beach	Silt/Sand	None-Very Sparse	Undercut	Creep/Leaning Trees	Stable	None/Little	High Flows	None	None	No
511	275	Right Bank	Moderate	High	Silt/Sand	Heavy	Flat/Beach	Silt/Sand	None-Very Sparse		None	Stable	None/Little	High Flows	None	None	No
512	60	Right Bank						Bedrock						High Flows	None	None	Yes
513	1364	Right Bank	Steep	Low	Silt/Sand	Heavy	Moderate	Cobbles	None-Very Sparse	Undercut	Creep/Leaning Trees	Stable	None/Little	High Flows	None	None	No
514	607	Right Bank	Steep	High	Silt/Sand	Heavy	Moderate	Boulders	None-Very Sparse	Undercut	Creep/Leaning Trees	Stable	None/Little	High Flows	None	None	Yes
515	1934	Right Bank	Moderate	High	Silt/Sand	Heavy	Flat/Beach	Silt/Sand	None-Very Sparse	Undercut	Creep/Leaning Trees	Stable	None/Little	High Flows	None	None	No
516	934	Right Bank	Moderate	Medium	Silt/Sand	Moderate	Flat/Beach	Silt/Sand	Sparse		Notching	Stable	None/Little	High Flows	None	None	No
120	1567	Left Bank	Moderate	High	Silt/Sand	Heavy	Moderate	Cobbles	None-Very Sparse		None	Stable	None/Little	High Flows	None	None	Yes
121	1678	Left Bank	Moderate	High	Silt/Sand	Heavy	Flat/Beach	Silt/Sand	None-Very Sparse	Undercut	Creep/Leaning Trees	Stable	None/Little	High Flows	None	None	No
122	181	Left Bank	Moderate	Low	Silt/Sand	Heavy	Flat/Beach	Silt/Sand	None-Very Sparse	Undercut	Creep/Leaning Trees	Stable	None/Little	High Flows	None	None	Yes
123	686	Left Bank	Moderate	High	Silt/Sand	Heavy	Flat/Beach	Silt/Sand	None-Very Sparse	Undercut	Creep/Leaning Trees	Stable	None/Little	High Flows	None	None	No
124	393	Left Bank	Moderate	Low	Silt/Sand	Heavy	Flat/Beach	Silt/Sand	None-Very Sparse	Undercut	Creep/Leaning Trees	Stable	None/Little	High Flows	None	None	No
125	243	Left Bank	Moderate	High	Silt/Sand	Heavy	Moderate	Boulders	None-Very Sparse	Undercut	None	Stable	None/Little	High Flows	None	None	No
126	350	Left Bank	Moderate	Low	Silt/Sand	Heavy	Moderate	Boulders	None-Very Sparse		None	Stable	None/Little	High Flows	None	None	No
127	100	Left Bank	Moderate	High	Silt/Sand	Heavy	Flat/Beach	Silt/Sand	None-Very Sparse	Undercut	Exposed Roots	Stable	None/Little	High Flows	None	None	No
128	278	Left Bank	Moderate	High	Silt/Sand	Heavy	Flat/Beach	Cobbles	None-Very Sparse	Undercut	Creep/Leaning Trees	Stable	None/Little	High Flows	None	None	No
129	121	Left Bank	Moderate	High	Silt/Sand	Heavy	Flat/Beach	Silt/Sand	None-Very Sparse	Undercut	Creep/Leaning Trees	Stable	None/Little	High Flows	None	None	No
130	185	Left Bank	Moderate	High	Silt/Sand	Heavy	Flat/Beach	Boulders	None-Very Sparse	Undercut	Exposed Roots	Stable	None/Little	High Flows	None	None	No
131	330	Left Bank	Moderate	High	Silt/Sand	Heavy	Moderate	Bedrock	None-Very Sparse		None	Stable	None/Little	High Flows	None	None	No
132	85	Left Bank	Steep	Medium	Silt/Sand	Heavy	Flat/Beach	Silt/Sand	None-Very Sparse	Slide	Creep/Leaning Trees	Eroded	Some	High Flows	None	None	No

ID	LENGTH (ft)	BANK	UPPER RIVERBANK				LOWER RIVERBANK			EROSION CHARACTERISTICS							
			SLOPE	HEIGHT	SEDIMENT	VEGETATION	SLOPE	SEDIMENT	VEGETATION	TYPE OF EROSION	POTENTIAL INDICATOR OF EROSION	STAGE OF EROSION	EXTENT OF EROSION	DOMINANT CAUSE	CONTRIBUTING CAUSE	CONTRIBUTING CAUSE 2	LAND-USE POTENTIAL CONTRIBUTING CAUSE
133	91	Left Bank	Moderate	High	Silt/Sand	Heavy	Moderate	Bedrock	None-Very Sparse		None	Stable	None/Little	High Flows	None	None	No
134	56	Left Bank	Steep	High	Silt/Sand	Heavy	Flat/Beach	Bedrock	None-Very Sparse	Undercut	Creep/Leaning Trees	Stable	None/Little	High Flows	None	None	No
135	119	Left Bank	Moderate	High	Silt/Sand	Heavy	Moderate	Bedrock	None-Very Sparse		Creep/Leaning Trees	Stable	None/Little	High Flows	None	None	No
136	100	Left Bank	Moderate	High	Silt/Sand	Heavy	Flat/Beach	Bedrock	None-Very Sparse	Undercut	Exposed Roots	Stable	None/Little	High Flows	None	None	No
137	387	Left Bank	Moderate	High	Silt/Sand	Heavy	Moderate	Boulders	None-Very Sparse		None	Stable	None/Little	High Flows	None	None	No
138	2013	Left Bank	Flat	Low	Silt/Sand	Heavy	Flat/Beach	Silt/Sand	Heavy		None	Stable	None/Little	High Flows	None	None	Yes
139	819	Left Bank	Moderate	High	Silt/Sand	Heavy	Flat/Beach	Silt/Sand	None-Very Sparse		None	Stable	None/Little	High Flows	None	None	Yes
140	322	Left Bank	Steep	High	Silt/Sand	Heavy	Flat/Beach	Silt/Sand	None-Very Sparse		Exposed Roots	Eroded	Some	High Flows	None	None	Yes
141	234	Left Bank	Vertical	High	Silt/Sand	Heavy	Flat/Beach	Silt/Sand	None-Very Sparse	Undercut	Creep/Leaning Trees	Eroded	Some	High Flows	None	None	Yes
142	262	Left Bank	Vertical	High	Silt/Sand	Heavy	Flat/Beach	Silt/Sand	None-Very Sparse	Slide	Creep/Leaning Trees	Eroded	Some	High Flows	None	None	Yes
143	117	Left Bank	Steep	High	Silt/Sand	Heavy	Flat/Beach	Silt/Sand	Sparse		None	Stable	None/Little	High Flows	None	None	Yes
144	89	Left Bank	Steep	High	Silt/Sand	Heavy	Flat/Beach	Silt/Sand	Moderate		None	Stable	None/Little	High Flows	None	None	Yes
145	67	Left Bank	Steep	High	Silt/Sand	Heavy	Flat/Beach	Silt/Sand	None-Very Sparse	Slide	Exposed Roots	Stable	None/Little	High Flows	None	None	No
146	409	Left Bank	Steep	High	Silt/Sand	Heavy	Flat/Beach	Silt/Sand	Moderate		None	Stable	None/Little	High Flows	None	None	No
147	1022	Left Bank	Moderate	High	Silt/Sand	Heavy	Flat/Beach	Silt/Sand	None-Very Sparse		Creep/Leaning Trees	Stable	None/Little	High Flows	None	None	No
148	166	Left Bank	Steep	High	Silt/Sand	Moderate	Flat/Beach	Gravel	None-Very Sparse	Slide	Creep/Leaning Trees	Eroded	Some	High Flows	None	None	No
149	104	Left Bank	Steep	High	Silt/Sand	Heavy	Flat/Beach	Silt/Sand	None-Very Sparse	Undercut	Creep/Leaning Trees	Stable	None/Little	High Flows	None	None	No
150	94	Left Bank	Steep	High	Silt/Sand	Heavy	Flat/Beach	Cobbles	None-Very Sparse	Topples	Creep/Leaning Trees	Eroded	Some	High Flows	None	None	No
151	569	Left Bank	Moderate	High	Silt/Sand	Heavy	Flat/Beach	Silt/Sand		Undercut	Creep/Leaning Trees	Stable	None/Little	High Flows	None	None	No
152	60	Left Bank	Steep	Medium	Silt/Sand	Heavy	Flat/Beach	Silt/Sand	None-Very Sparse	Planar Slip	Creep/Leaning Trees	Eroded	Some	High Flows	None	None	No
153	669	Left Bank	Steep	High	Silt/Sand	Heavy	Flat/Beach	Silt/Sand	None-Very Sparse	Undercut	Creep/Leaning Trees	Stable	None/Little	High Flows	None	None	No
154	157	Left Bank	Flat	Low	Silt/Sand	Heavy	Flat/Beach	Silt/Sand	None-Very Sparse	Undercut	Creep/Leaning Trees	Stable	None/Little	High Flows	None	None	No
155	213	Left Bank	Flat	Low	Silt/Sand	Heavy	Flat/Beach	Cobbles	None-Very Sparse		None	Stable	None/Little	High Flows	None	None	No
156	147	Left Bank	Moderate	High	Silt/Sand	Heavy	Flat/Beach	Silt/Sand	None-Very Sparse		None	Stable	None/Little	High Flows	None	None	No
157	51	Left Bank	Moderate	High	Silt/Sand	Heavy	Flat/Beach	Cobbles	None-Very Sparse		None	Stable	None/Little	High Flows	None	None	No
158	171	Left Bank	Vertical	High	Silt/Sand	Moderate	Flat/Beach	Silt/Sand	None-Very Sparse	Slide	Other	Eroded	Some	High Flows	None	None	No





ID	LENGTH (ft)	BANK	UPPER RIVERBANK				LOWER RIVERBANK			EROSION CHARACTERISTICS							
			SLOPE	HEIGHT	SEDIMENT	VEGETATION	SLOPE	SEDIMENT	VEGETATION	TYPE OF EROSION	POTENTIAL INDICATOR OF EROSION	STAGE OF EROSION	EXTENT OF EROSION	DOMINANT CAUSE	CONTRIBUTING CAUSE	CONTRIBUTING CAUSE 2	LAND-USE POTENTIAL CONTRIBUTING CAUSE
184	221	Left Bank	Steep	High	Silt/Sand	Heavy	Flat/Beach	Silt/Sand	None-Very Sparse	Undercut	Other	Potential Future Erosion	Some	High Flows	None	None	Yes
185	92	Left Bank	Steep	High	Silt/Sand	Heavy	Flat/Beach	Silt/Sand	None-Very Sparse	Slide	Creep/Leaning Trees	Potential Future Erosion	Some	High Flows	None	None	Yes
186	149	Left Bank	Steep	High	Silt/Sand	Heavy	Flat/Beach	Silt/Sand	None-Very Sparse	Undercut	Creep/Leaning Trees	Potential Future Erosion	Some	High Flows	None	None	Yes
187	275	Left Bank	Overhanging	High	Silt/Sand	Moderate	Flat/Beach	Silt/Sand	None-Very Sparse	Slide	Creep/Leaning Trees	Eroded	Some	High Flows	None	None	Yes
188	168	Left Bank	Steep	High	Silt/Sand	Moderate	Flat/Beach	Silt/Sand	None-Very Sparse	Slide	Creep/Leaning Trees	Eroded	Some	High Flows	None	None	Yes
189	132	Left Bank	Steep	High	Silt/Sand	Heavy	Flat/Beach	Silt/Sand		Undercut	Creep/Leaning Trees	Stable	None/Little	High Flows	None	None	Yes
190	219	Left Bank	Overhanging	High	Silt/Sand	Moderate	Flat/Beach	Silt/Sand	None-Very Sparse	Slide	Exposed Roots	Eroded	Some	High Flows	None	None	Yes
191	57	Left Bank	Steep	High	Silt/Sand	Moderate	Flat/Beach	Silt/Sand	None-Very Sparse		None	Stable	None/Little	High Flows	None	None	Yes
192	83	Left Bank	Overhanging	High	Silt/Sand	Moderate	Flat/Beach	Silt/Sand	None-Very Sparse	Slide	Overhanging Bank	Eroded	Some	High Flows	None	None	Yes
193	381	Left Bank	Steep	High	Silt/Sand	Heavy	Flat/Beach	Silt/Sand	None-Very Sparse	Undercut	Creep/Leaning Trees	Stable	None/Little	High Flows	None	None	Yes
194	216	Left Bank	Overhanging	High	Silt/Sand	Moderate	Flat/Beach	Silt/Sand	None-Very Sparse	Slide	Overhanging Bank	Eroded	Some	High Flows	None	None	Yes
195	311	Left Bank	Steep	High	Silt/Sand	Heavy	Flat/Beach	Silt/Sand	None-Very Sparse		Creep/Leaning Trees	Potential Future Erosion	Some	High Flows	None	None	Yes
196	201	Left Bank	Overhanging	High	Silt/Sand	Moderate	Flat/Beach	Silt/Sand	None-Very Sparse	Slide	Overhanging Bank	Eroded	Some	High Flows	None	None	Yes
197	189	Left Bank	Steep	High	Silt/Sand	Heavy	Flat/Beach	Silt/Sand	None-Very Sparse		None	Stable	None/Little	High Flows	None	None	Yes
198	195	Left Bank	Moderate	High	Silt/Sand	Heavy	Flat/Beach	Silt/Sand	None-Very Sparse	Undercut	Creep/Leaning Trees	Stable	None/Little	High Flows	None	None	Yes
199	294	Left Bank	Overhanging	High	Silt/Sand	Moderate	Flat/Beach	Silt/Sand	None-Very Sparse	Slide	Overhanging Bank	Eroded	Some	High Flows	None	None	Yes
200	443	Left Bank	Steep	High	Silt/Sand	Heavy	Flat/Beach	Silt/Sand	None-Very Sparse	Undercut	Creep/Leaning Trees	Eroded	Some	High Flows	None	None	Yes
202	617	Left Bank	Steep	High	Silt/Sand	Heavy	Flat/Beach	Silt/Sand	None-Very Sparse	Undercut	Creep/Leaning Trees	Stable	None/Little	High Flows	None	None	Yes
203	667	Left Bank	Moderate	High	Silt/Sand	Heavy	Flat/Beach	Silt/Sand	None-Very Sparse	Undercut	Creep/Leaning Trees	Stable	None/Little	High Flows	None	None	Yes
204	278	Left Bank	Steep	High	Silt/Sand	Moderate	Flat/Beach	Silt/Sand	None-Very Sparse	Slide	Other	Eroded	Some	High Flows	None	None	Yes
205	34	Left Bank	Moderate	Medium	Boulders	Moderate	Flat/Beach	Silt/Sand	None-Very Sparse	Gulley	Creep/Leaning Trees	Stable	None/Little	High Flows	None	None	No
206	195	Left Bank	Moderate	High	Silt/Sand	Heavy	Flat/Beach	Silt/Sand	None-Very Sparse		None	Stable	None/Little	High Flows	None	None	No
207	170	Left Bank	Moderate	Medium	Silt/Sand	Heavy	Flat/Beach	Silt/Sand	None-Very Sparse	Undercut	Creep/Leaning Trees	Eroded	Some	High Flows	None	None	No

ID	LENGTH (ft)	BANK	UPPER RIVERBANK				LOWER RIVERBANK			EROSION CHARACTERISTICS							
			SLOPE	HEIGHT	SEDIMENT	VEGETATION	SLOPE	SEDIMENT	VEGETATION	TYPE OF EROSION	POTENTIAL INDICATOR OF EROSION	STAGE OF EROSION	EXTENT OF EROSION	DOMINANT CAUSE	CONTRIBUTING CAUSE	CONTRIBUTING CAUSE 2	LAND-USE POTENTIAL CONTRIBUTING CAUSE
208	52	Left Bank	Moderate	Medium	Silt/Sand	Heavy	Moderate	Boulders	None-Very Sparse		None	Stable	None/Little	High Flows	None	None	No
209	58	Left Bank	Vertical	High	Bedrock	None-Very Sparse	Moderate	Boulders	None-Very Sparse		None	Stable	None/Little	High Flows	None	None	Yes
210	216	Left Bank	Moderate	Low	Silt/Sand	Heavy	Moderate	Boulders	None-Very Sparse		None	Stable	None/Little	High Flows	None	None	Yes
211	978	Left Bank	Moderate	High	Silt/Sand	Heavy	Moderate	Gravel	None-Very Sparse		None	Stable	None/Little	High Flows	None	None	Yes
212	252	Left Bank	Steep	High	Silt/Sand	Heavy	Flat/Beach	Silt/Sand	None-Very Sparse		None	Potential Future Erosion	Some	High Flows	None	None	No
213	276	Left Bank	Moderate	High	Silt/Sand	Heavy	Moderate	Boulders	None-Very Sparse		None	Stable	None/Little	High Flows	None	None	No
214	195	Left Bank	Moderate	High	Silt/Sand	Heavy	Moderate	Cobbles	None-Very Sparse		None	Stable	None/Little	High Flows	None	None	No
215	48	Left Bank	Moderate	High	Silt/Sand	Heavy	Moderate	Silt/Sand	None-Very Sparse	Undercut	None	Stable	None/Little	High Flows	None	None	No
216	546	Left Bank	Moderate	High	Silt/Sand	Heavy	Moderate	Cobbles	None-Very Sparse		None	Stable	None/Little	High Flows	None	None	No
217	139	Left Bank	Moderate	High	Silt/Sand	Heavy	Moderate	Cobbles	None-Very Sparse	Undercut	Overhanging Bank	Potential Future Erosion	Some	High Flows	None	None	No
218	227	Left Bank	Moderate	High	Silt/Sand	Heavy	Moderate	Cobbles	None-Very Sparse		None	Potential Future Erosion	Some	High Flows	None	None	No
219	54	Left Bank	Vertical	High	Bedrock	None-Very Sparse	Vertical	Bedrock	None-Very Sparse		None	Stable	None/Little	High Flows	None	None	Yes
220	388	Left Bank	Moderate	High	Silt/Sand	Heavy	Moderate	Cobbles	None-Very Sparse	Undercut	Creep/Leaning Trees	Potential Future Erosion	Some	High Flows	None	None	No
221	1006	Left Bank	Flat	Low	Silt/Sand	Heavy	Flat/Beach	Silt/Sand	Heavy		None	Stable	None/Little	High Flows	None	None	No
222	33	Left Bank	Flat	Low	Bedrock	None-Very Sparse	Flat/Beach	Bedrock	None-Very Sparse		None	Stable	None/Little	High Flows	None	None	No
223	14	Left Bank	Flat	Low	Bedrock	None-Very Sparse	Flat/Beach	Bedrock	None-Very Sparse		None	Stable	None/Little	High Flows	None	None	No
224	121	Left Bank	Flat	Low	Silt/Sand	Heavy	Flat/Beach	Silt/Sand	Heavy		None	Stable	None/Little	High Flows	None	None	No
225	135	Left Bank	Flat	Low	Silt/Sand	Heavy	Flat/Beach	Silt/Sand	None-Very Sparse		None	Stable	None/Little	High Flows	None	None	No
226	503	Left Bank	Flat	Low	Silt/Sand	Heavy	Flat/Beach	Silt/Sand	Heavy		None	Stable	None/Little	High Flows	None	None	No
227	555	Left Bank	Flat	Low	Silt/Sand	Heavy	Flat/Beach	Silt/Sand	None-Very Sparse		None	Stable	None/Little	High Flows	None	None	No
228	304	Left Bank	Moderate	Low	Silt/Sand	Heavy	Flat/Beach	Silt/Sand	None-Very Sparse	Undercut	Creep/Leaning Trees	Stable	None/Little	High Flows	None	None	No
229	162	Left Bank	Moderate	Medium	Silt/Sand	Heavy	Flat/Beach	Silt/Sand	Heavy		None	Stable	None/Little	High Flows	None	None	Yes
230	102	Left Bank	Moderate	Medium	Silt/Sand	Moderate	Flat/Beach	Silt/Sand	None-Very Sparse		Creep/Leaning Trees	Potential Future Erosion	Some	High Flows	None	None	Yes
231	128	Left Bank	Moderate	Medium	Silt/Sand	Heavy	Flat/Beach	Silt/Sand	Heavy		None	Stable	None/Little	High Flows	None	None	Yes

ID	LENGTH (ft)	BANK	UPPER RIVERBANK				LOWER RIVERBANK			EROSION CHARACTERISTICS							
			SLOPE	HEIGHT	SEDIMENT	VEGETATION	SLOPE	SEDIMENT	VEGETATION	TYPE OF EROSION	POTENTIAL INDICATOR OF EROSION	STAGE OF EROSION	EXTENT OF EROSION	DOMINANT CAUSE	CONTRIBUTING CAUSE	CONTRIBUTING CAUSE 2	LAND-USE POTENTIAL CONTRIBUTING CAUSE
232	100	Left Bank	Moderate	Medium	Silt/Sand	Heavy	Flat/Beach	Silt/Sand	None-Very Sparse		Creep/Leaning Trees	Stable	None/Little	High Flows	None	None	Yes
233	209	Left Bank	Steep	Medium	Silt/Sand	Moderate	Moderate	Boulders	None-Very Sparse		None	Stable	None/Little	High Flows	None	None	Yes
234	90	Left Bank	Moderate	Medium	Silt/Sand	Heavy	Flat/Beach	Silt/Sand	Moderate		None	Stable	None/Little	High Flows	None	None	No
235	46	Left Bank	Moderate	Medium	Silt/Sand	Heavy	Moderate	Boulders	None-Very Sparse		None	Stable	None/Little	High Flows	None	None	No
236	34	Left Bank	Moderate	Medium	Silt/Sand	Heavy	Flat/Beach	Silt/Sand	None-Very Sparse		None	Stable	None/Little	High Flows	None	None	No
237	54	Left Bank	Moderate	Medium	Silt/Sand	Heavy	Flat/Beach	Silt/Sand	Moderate		None	Stable	None/Little	High Flows	None	None	No
238	103	Left Bank	Moderate	Medium	Silt/Sand	Heavy	Flat/Beach	Silt/Sand	None-Very Sparse		Notching	Potential Future Erosion	Some	High Flows	None	None	No
239	151	Left Bank	Moderate	Low	Silt/Sand	Heavy	Flat/Beach	Silt/Sand	None-Very Sparse	Undercut	Creep/Leaning Trees	Stable	Some	High Flows	None	None	No
240	497	Left Bank	Moderate	Low	Silt/Sand	Moderate	Flat/Beach	Silt/Sand	None-Very Sparse	Undercut	Creep/Leaning Trees	Stable	Some	High Flows	None	None	No
241	448	Left Bank	Steep	Low	Silt/Sand	Moderate	Flat/Beach	Silt/Sand	None-Very Sparse	Undercut	Exposed Roots	Eroded	Some	High Flows	None	None	No
436	271	Right Bank	Moderate	High	Silt/Sand	Heavy	Moderate	Bedrock	None-Very Sparse		None	Stable	None/Little	High Flows	Moderate Flows	None	No
437	354	Right Bank	Moderate	High	Silt/Sand	Heavy	Flat/Beach	Silt/Sand	None-Very Sparse	Undercut	Creep/Leaning Trees	Stable	None/Little	High Flows	Moderate Flows	None	No
438	281	Right Bank	Moderate	Low	Silt/Sand	Heavy	Flat/Beach	Silt/Sand	Heavy		None	Stable	None/Little	High Flows	Moderate Flows	None	Yes
439	452	Right Bank	Moderate	High	Silt/Sand	Heavy	Flat/Beach	Silt/Sand	None-Very Sparse	Undercut	Creep/Leaning Trees	Stable	None/Little	High Flows	Moderate Flows	None	No
440	233	Right Bank	Moderate	High	Silt/Sand	Heavy	Moderate	Bedrock	None-Very Sparse	Undercut	Creep/Leaning Trees	Stable	None/Little	High Flows	Moderate Flows	None	No
441	890	Right Bank	Steep	High	Silt/Sand	Moderate	Flat/Beach	Silt/Sand	Sparse		None	Stable	None/Little	High Flows	Moderate Flows	None	Yes
115	185	Left Bank	Steep	High	Silt/Sand	Heavy	Flat/Beach	Silt/Sand	None-Very Sparse	Undercut	Creep/Leaning Trees	Stable	None/Little	High Flows	Moderate Flows	None	Yes
116	174	Left Bank	Steep	High	Silt/Sand	Moderate	Flat/Beach	Silt/Sand	None-Very Sparse	Undercut	Other	Eroded	Some	High Flows	Moderate Flows	None	Yes
117	211	Left Bank	Steep	Medium	Silt/Sand	Heavy	Flat/Beach	Silt/Sand	None-Very Sparse	Undercut	Creep/Leaning Trees	Stable	None/Little	High Flows	Moderate Flows	None	Yes
118	765	Left Bank	Moderate	Low	Silt/Sand	Heavy	Flat/Beach	Silt/Sand	None-Very Sparse	Undercut	Creep/Leaning Trees	Stable	None/Little	High Flows	Moderate Flows	None	Yes
119	397	Left Bank	Steep	High	Silt/Sand	Moderate	Flat/Beach	Silt/Sand	None-Very Sparse	Slide	Creep/Leaning Trees	Eroded	Some to Extensive	High Flows	Moderate Flows	None	Yes
428	491	Right Bank	Moderate	High	Silt/Sand	Moderate	Flat/Beach	Silt/Sand	None-Very Sparse	Undercut	Creep/Leaning Trees	Stable	None/Little	High Flows	None	None	No
429	41	Right Bank	Moderate	High	Silt/Sand	Heavy	Flat/Beach	Silt/Sand	None-Very Sparse	Undercut	Creep/Leaning Trees	Stable	None/Little	High Flows	None	None	No
430	795	Right Bank	Moderate	High	Silt/Sand	Heavy	Flat/Beach	Cobbles	None-Very Sparse	Undercut	Creep/Leaning Trees	Stable	None/Little	High Flows	None	None	No
431	905	Right Bank	Moderate	High	Silt/Sand	Heavy	Moderate	Boulders	None-Very Sparse		None	Stable	None/Little	High Flows	None	None	Yes



ID	LENGTH (ft)	BANK	UPPER RIVERBANK				LOWER RIVERBANK			EROSION CHARACTERISTICS							
			SLOPE	HEIGHT	SEDIMENT	VEGETATION	SLOPE	SEDIMENT	VEGETATION	TYPE OF EROSION	POTENTIAL INDICATOR OF EROSION	STAGE OF EROSION	EXTENT OF EROSION	DOMINANT CAUSE	CONTRIBUTING CAUSE	CONTRIBUTING CAUSE 2	LAND-USE POTENTIAL CONTRIBUTING CAUSE
426	57	Right Bank	Moderate	High	Silt/Sand	Heavy	Flat/Beach	Bedrock	None-Very Sparse	Undercut	Creep/Leaning Trees	Stable	None/Little	High Flows	Northfield Mountain Operations	None	No
427	154	Right Bank	Moderate	High	Silt/Sand	Heavy	Flat/Beach	Cobbles	None-Very Sparse	Undercut	Creep/Leaning Trees	Stable	None/Little	High Flows	Northfield Mountain Operations	None	No
89	1058	Left Bank	Moderate	High	Silt/Sand	Heavy	Moderate	Cobbles	None-Very Sparse	Undercut	None	Stable	None/Little	High Flows	Northfield Mountain Operations	None	Yes
90	62	Left Bank	Steep	High	Silt/Sand	Moderate	Flat/Beach	Silt/Sand	None-Very Sparse	Slide	Overhanging Bank	Eroded	Extensive	High Flows	Northfield Mountain Operations	None	Yes
91	196	Left Bank	Steep	High	Silt/Sand	Moderate	Flat/Beach	Silt/Sand	None-Very Sparse	Undercut	Creep/Leaning Trees	Eroded	Some	High Flows	Northfield Mountain Operations	None	Yes
92	437	Left Bank	Steep	High	Silt/Sand	Moderate	Flat/Beach	Silt/Sand	None-Very Sparse	Undercut	Creep/Leaning Trees	Eroded	Some	High Flows	Northfield Mountain Operations	None	Yes
93	137	Left Bank	Steep	High	Silt/Sand	Moderate	Flat/Beach	Silt/Sand	None-Very Sparse	Undercut	Creep/Leaning Trees	Potential Future Erosion	Some	High Flows	Northfield Mountain Operations	None	Yes
94	159	Left Bank	Steep	High	Silt/Sand	Moderate	Flat/Beach	Silt/Sand	None-Very Sparse	Undercut	Exposed Roots	Eroded	Some	High Flows	Northfield Mountain Operations	None	Yes
95	464	Left Bank	Overhanging	High	Silt/Sand	Moderate	Flat/Beach	Gravel	None-Very Sparse	Slide	Creep/Leaning Trees	Eroded	Some	High Flows	Northfield Mountain Operations	None	Yes
96	169	Left Bank	Overhanging	High	Silt/Sand	Moderate	Flat/Beach	Silt/Sand	None-Very Sparse	Slide	Creep/Leaning Trees	Eroded	Some	High Flows	Northfield Mountain Operations	None	Yes
97	327	Left Bank	Steep	High	Silt/Sand	Heavy	Flat/Beach	Silt/Sand	None-Very Sparse	Undercut	Creep/Leaning Trees	Eroded	Some	High Flows	Northfield Mountain Operations	None	Yes
98	385	Left Bank	Moderate	High	Silt/Sand	Heavy	Flat/Beach	Silt/Sand	None-Very Sparse	Topples	Creep/Leaning Trees	Stable	None/Little	High Flows	Northfield Mountain Operations	None	No
99	246	Left Bank	Moderate	High	Silt/Sand	Heavy	Flat/Beach	Silt/Sand	None-Very Sparse	Undercut	Creep/Leaning Trees	Stable	None/Little	High Flows	Northfield Mountain Operations	None	No
100	71	Left Bank	Moderate	Low	Boulders	Moderate	Moderate	Boulders	None-Very Sparse		None	Stable	None/Little	High Flows	Northfield Mountain Operations	None	No
101	209	Left Bank	Steep	High	Silt/Sand	Moderate	Flat/Beach	Silt/Sand	None-Very Sparse	Undercut	Creep/Leaning Trees	Eroded	Some	High Flows	Northfield Mountain Operations	None	Yes
420	1291	Right Bank	Steep	High	Silt/Sand	Heavy	Flat/Beach	Gravel	Moderate		None	Stable	None/Little	High Flows	Moderate Flows	None	Yes
84	305	Left Bank	Moderate	High	Silt/Sand	Heavy	Flat/Beach	Boulders	None-Very Sparse		None	Stable	None/Little	High Flows	Moderate Flows	None	Yes

ID	LENGTH (ft)	BANK	UPPER RIVERBANK				LOWER RIVERBANK			EROSION CHARACTERISTICS							
			SLOPE	HEIGHT	SEDIMENT	VEGETATION	SLOPE	SEDIMENT	VEGETATION	TYPE OF EROSION	POTENTIAL INDICATOR OF EROSION	STAGE OF EROSION	EXTENT OF EROSION	DOMINANT CAUSE	CONTRIBUTING CAUSE	CONTRIBUTING CAUSE 2	LAND-USE POTENTIAL CONTRIBUTING CAUSE
85	1231	Left Bank	Moderate	Low	Boulders	Heavy	Moderate	Boulders	None-Very Sparse		None	Stable	None/Little	High Flows	Moderate Flows	None	Yes
86	1284	Left Bank	Moderate	Low	Silt/Sand	Heavy	Moderate	Boulders	None-Very Sparse		Creep/Leaning Trees	Stable	None/Little	High Flows	Moderate Flows	None	Yes
87	208	Left Bank	Overhanging	High	Silt/Sand	Sparse	Flat/Beach	Silt/Sand	None-Very Sparse	Slide	Creep/Leaning Trees	Eroded	Some to Extensive	High Flows	Moderate Flows	None	No
88	201	Left Bank	Steep	Low	Silt/Sand	Heavy	Flat/Beach	Silt/Sand	None-Very Sparse		Notching	Stable	None/Little	High Flows	Moderate Flows	None	Yes
396	413	Right Bank	Moderate	High	Silt/Sand	Heavy	Moderate	Bedrock	None-Very Sparse		None	Stable	None/Little	High Flows	Boats	None	No
397	286	Right Bank	Moderate	High	Silt/Sand	Heavy	Flat/Beach	Silt/Sand	None-Very Sparse	Undercut	None	Stable	None/Little	High Flows	Boats	None	No
398	681	Right Bank	Moderate	High	Silt/Sand	Heavy	Moderate	Bedrock	None-Very Sparse	Undercut	None	Stable	None/Little	High Flows	Boats	None	No
399	476	Right Bank	Moderate	High	Silt/Sand	Heavy	Flat/Beach	Silt/Sand	Heavy		None	Stable	None/Little	High Flows	Boats	None	No
400	130	Right Bank	Moderate	High	Silt/Sand	Heavy	Flat/Beach	Silt/Sand	None-Very Sparse	Undercut	Creep/Leaning Trees	Stable	None/Little	High Flows	Boats	None	No
401	171	Right Bank	Steep	High	Silt/Sand	Heavy	Moderate	Boulders	None-Very Sparse	Undercut	None	Stable	None/Little	High Flows	Boats	None	No
402	126	Right Bank	Steep	High	Silt/Sand	Heavy	Steep	Bedrock	None-Very Sparse		None	Stable	None/Little	High Flows	Boats	None	No
403	635	Right Bank	Steep	High	Bedrock	Moderate	Vertical	Bedrock	None-Very Sparse		None	Stable	None/Little	High Flows	Boats	None	No
404	142	Right Bank	Steep	High	Silt/Sand	Heavy	Steep	Bedrock	None-Very Sparse		None	Stable	None/Little	High Flows	Boats	None	No
405	407	Right Bank	Moderate	High	Silt/Sand	Heavy	Moderate	Boulders	None-Very Sparse		None	Stable	None/Little	High Flows	Boats	None	No
406	88	Right Bank	Moderate	High	Silt/Sand	Heavy	Flat/Beach	Gravel	None-Very Sparse		None	Stable	None/Little	High Flows	Boats	None	No
407	485	Right Bank	Steep	High	Bedrock	Moderate	Moderate	Bedrock	None-Very Sparse		None	Stable	None/Little	High Flows	Boats	None	No
408	66	Right Bank						Bedrock						High Flows	Moderate Flows	Boats	No
409	1308	Right Bank	Steep	High	Bedrock	Sparse	Steep	Bedrock	None-Very Sparse		None	Stable	None/Little	High Flows	Moderate Flows	Boats	No
410	861	Right Bank	Steep	High	Silt/Sand	Heavy	Moderate	Boulders	None-Very Sparse	Undercut	Creep/Leaning Trees	Stable	None/Little	High Flows	Moderate Flows	Boats	No
411	438	Right Bank	Steep	High	Silt/Sand	Heavy	Moderate	Boulders	None-Very Sparse		None	Stable	None/Little	High Flows	Moderate Flows	Boats	No
412	294	Right Bank	Moderate	High	Silt/Sand	Heavy	Moderate	Boulders	None-Very Sparse	Undercut	None	Stable	None/Little	High Flows	Moderate Flows	Boats	Yes
413	345	Right Bank	Moderate	High	Silt/Sand	Heavy	Steep	Bedrock	None-Very Sparse	Undercut	None	Stable	None/Little	High Flows	Moderate Flows	Boats	No
414	335	Right Bank	Moderate	High	Silt/Sand	Heavy	Flat/Beach	Cobbles	None-Very Sparse	Undercut	Creep/Leaning Trees	Stable	None/Little	High Flows	Moderate Flows	Boats	No
415	370	Right Bank	Steep	High	Silt/Sand	Heavy	Flat/Beach	Silt/Sand	None-Very Sparse	Rotational Slump	Creep/Leaning Trees	Stable	None/Little	High Flows	Moderate Flows	Boats	No
416	1064	Right Bank	Moderate	Medium	Silt/Sand	Heavy	Flat/Beach	Gravel	None-Very Sparse		None	Stable	None/Little	High Flows	Moderate Flows	Boats	Yes

ID	LENGTH (ft)	BANK	UPPER RIVERBANK				LOWER RIVERBANK			EROSION CHARACTERISTICS							
			SLOPE	HEIGHT	SEDIMENT	VEGETATION	SLOPE	SEDIMENT	VEGETATION	TYPE OF EROSION	POTENTIAL INDICATOR OF EROSION	STAGE OF EROSION	EXTENT OF EROSION	DOMINANT CAUSE	CONTRIBUTING CAUSE	CONTRIBUTING CAUSE 2	LAND-USE POTENTIAL CONTRIBUTING CAUSE
417	705	Right Bank	Moderate	Medium	Silt/Sand	Heavy	Flat/Beach	Gravel	Heavy		None	Stable	None/Little	High Flows	Moderate Flows	Boats	Yes
418	1536	Right Bank	Moderate	High	Silt/Sand	Heavy	Moderate	Boulders	None-Very Sparse		None	Stable	None/Little	High Flows	Moderate Flows	Boats	Yes
419	113	Right Bank	Moderate	High	Silt/Sand	Sparse	Flat/Beach	Gravel	None-Very Sparse		None	Stable	None/Little	High Flows	Moderate Flows	Boats	No
46	252	Left Bank	Moderate	Medium	Silt/Sand	Heavy	Moderate	Bedrock	None-Very Sparse		None	Stable	None/Little	High Flows	Boats	None	No
47	125	Left Bank	Flat	Low	Silt/Sand	Heavy	Flat/Beach	Silt/Sand	None-Very Sparse		None	Stable	None/Little	High Flows	Boats	None	No
48	69	Left Bank	Moderate	High	Silt/Sand	Heavy	Flat/Beach	Boulders	None-Very Sparse		None	Stable	None/Little	High Flows	Boats	None	No
49	1018	Left Bank	Moderate	High	Silt/Sand	Heavy	Moderate	Bedrock	None-Very Sparse		None	Stable	None/Little	High Flows	Boats	None	No
50	263	Left Bank	Moderate	High	Silt/Sand	Heavy	Flat/Beach	Gravel	None-Very Sparse	Undercut	None	Stable	None/Little	High Flows	Boats	None	No
51	98	Left Bank	Steep	High	Bedrock	Moderate	Steep	Bedrock	None-Very Sparse		None	Stable	None/Little	High Flows	Boats	None	No
52	1468	Left Bank	Moderate	High	Silt/Sand	Heavy	Moderate	Bedrock	None-Very Sparse		None	Stable	None/Little	High Flows	Boats	None	No
53	792	Left Bank	Steep	High	Silt/Sand	Heavy	Moderate	Boulders	None-Very Sparse		None	Stable	None/Little	High Flows	Boats	None	No
54	845	Left Bank	Moderate	High	Silt/Sand	Heavy	Flat/Beach	Cobbles	None-Very Sparse		None	Stable	None/Little	High Flows	Boats	None	No
55	98	Left Bank	Moderate	Low	Bedrock	Sparse	Moderate	Bedrock	None-Very Sparse		None	Stable	None/Little	High Flows	Boats	None	Yes
56	228	Left Bank	Moderate	High	Silt/Sand	Moderate	Moderate	Bedrock	None-Very Sparse		None	Stable	None/Little	High Flows	Boats	None	Yes
57	58	Left Bank	Vertical	High	Bedrock	None-Very Sparse	Moderate	Bedrock	None-Very Sparse		None	Stable	None/Little	High Flows	Moderate Flows	Boats	No
58	1682	Left Bank	Moderate	High	Silt/Sand	Heavy	Moderate	Bedrock	None-Very Sparse		None	Stable	None/Little	High Flows	Moderate Flows	Boats	No
59	203	Left Bank	Moderate	High	Silt/Sand	Heavy	Moderate	Boulders	None-Very Sparse	Undercut	None	Stable	None/Little	High Flows	Moderate Flows	Boats	No
60	95	Left Bank	Moderate	High	Silt/Sand	Heavy	Moderate	Bedrock	None-Very Sparse		None	Stable	None/Little	High Flows	Moderate Flows	Boats	No
61	400	Left Bank	Moderate	High	Silt/Sand	Heavy	Moderate	Boulders	None-Very Sparse	Undercut	None	Stable	None/Little	High Flows	Moderate Flows	Boats	No
62	618	Left Bank	Moderate	High	Silt/Sand	Heavy	Moderate	Bedrock	None-Very Sparse	Undercut	None	Stable	None/Little	High Flows	Moderate Flows	Boats	Yes
63	402	Left Bank	Moderate	High	Silt/Sand	Heavy	Moderate	Boulders	None-Very Sparse	Undercut	None	Stable	None/Little	High Flows	Moderate Flows	Boats	Yes
64	194	Left Bank	Moderate	High	Silt/Sand	Heavy	Moderate	Cobbles	None-Very Sparse	Undercut	None	Stable	None/Little	High Flows	Moderate Flows	Boats	Yes
65	147	Left Bank	Overhanging	High	Silt/Sand	Moderate	Moderate	Cobbles	None-Very Sparse	Slide	Creep/Leaning Trees	Eroded	Some	High Flows	Moderate Flows	Boats	Yes
66	709	Left Bank	Moderate	High	Silt/Sand	Heavy	Moderate	Cobbles	None-Very Sparse		None	Stable	None/Little	High Flows	Moderate Flows	Boats	Yes
67	280	Left Bank	Moderate	High	Silt/Sand	Heavy	Moderate	Boulders	None-Very Sparse	Undercut	Creep/Leaning Trees	Stable	None/Little	High Flows	Moderate Flows	Boats	Yes



ID	LENGTH (ft)	BANK	UPPER RIVERBANK				LOWER RIVERBANK			EROSION CHARACTERISTICS							
			SLOPE	HEIGHT	SEDIMENT	VEGETATION	SLOPE	SEDIMENT	VEGETATION	TYPE OF EROSION	POTENTIAL INDICATOR OF EROSION	STAGE OF EROSION	EXTENT OF EROSION	DOMINANT CAUSE	CONTRIBUTING CAUSE	CONTRIBUTING CAUSE 2	LAND-USE POTENTIAL CONTRIBUTING CAUSE
68	100	Left Bank	Moderate	High	Silt/Sand	Heavy	Moderate	Bedrock	None-Very Sparse		None	Stable	None/Little	High Flows	Moderate Flows	Boats	Yes
69	383	Left Bank	Moderate	High	Silt/Sand	Heavy	Flat/Beach	Gravel	None-Very Sparse		None	Stable	None/Little	High Flows	Moderate Flows	Boats	Yes
70	104	Left Bank	Steep	High	Silt/Sand	Sparse	Flat/Beach	Gravel	None-Very Sparse	Slide	Creep/Leaning Trees	Active Erosion	Extensive	High Flows	Moderate Flows	Boats	No
71	82	Left Bank	Steep	High	Silt/Sand	Heavy	Flat/Beach	Silt/Sand	None-Very Sparse		None	Stable	None/Little	High Flows	Moderate Flows	Boats	No
72	218	Left Bank	Steep	High	Silt/Sand	Heavy	Flat/Beach	Cobbles	None-Very Sparse		None	Stable	None/Little	High Flows	Moderate Flows	Boats	No
73	195	Left Bank	Steep	High	Silt/Sand	Heavy	Flat/Beach	Cobbles	None-Very Sparse	Undercut	Creep/Leaning Trees	Stable	None/Little	High Flows	Moderate Flows	Boats	No
74	157	Left Bank	Steep	High	Silt/Sand	Heavy	Moderate	Cobbles	None-Very Sparse		Creep/Leaning Trees	Stable	None/Little	High Flows	Moderate Flows	Boats	No
75	32	Left Bank	Vertical	High	Silt/Sand	Sparse	Flat/Beach	Silt/Sand	None-Very Sparse	Slide	Creep/Leaning Trees	Active Erosion	Extensive	High Flows	Moderate Flows	Boats	No
76	86	Left Bank	Steep	High	Silt/Sand	Heavy	Moderate	Cobbles	None-Very Sparse		Creep/Leaning Trees	Stable	None/Little	High Flows	Moderate Flows	Boats	No
77	154	Left Bank	Steep	High	Silt/Sand	Sparse	Flat/Beach	Gravel	None-Very Sparse	Slide	Creep/Leaning Trees	Eroded	Some to Extensive	High Flows	Moderate Flows	Boats	No
78	135	Left Bank	Steep	High	Silt/Sand	Heavy	Flat/Beach	Gravel	None-Very Sparse		Creep/Leaning Trees	Stable	None/Little	High Flows	Moderate Flows	Boats	No
79	142	Left Bank	Moderate	High	Silt/Sand	Heavy	Flat/Beach	Gravel	None-Very Sparse		None	Stable	None/Little	High Flows	Moderate Flows	Boats	No
80	418	Left Bank	Moderate	High	Silt/Sand	Heavy	Moderate	Boulders	None-Very Sparse		None	Stable	None/Little	High Flows	Moderate Flows	Boats	Yes
344	683	Right Bank	Moderate	Low	Silt/Sand	Heavy	Flat/Beach	Silt/Sand	Sparse		None	Stable	None/Little	Boats	None	None	Yes
345	170	Right Bank	Moderate	Low	Silt/Sand	Heavy	Moderate	Boulders	None-Very Sparse		None	Stable	None/Little	Boats	None	None	Yes
346	397	Right Bank	Moderate	Low	Silt/Sand	Heavy	Flat/Beach	Silt/Sand	Sparse		None	Stable	None/Little	Boats	None	None	Yes
347	797	Right Bank	Flat	Low	Silt/Sand	Heavy	Flat/Beach	Cobbles	None-Very Sparse		None	Stable	None/Little	Boats	None	None	Yes
348	92	Right Bank	Flat	Low	Silt/Sand	Heavy	Flat/Beach	Silt/Sand	None-Very Sparse		None	Stable	None/Little	Boats	None	None	Yes
349	52	Right Bank						Bedrock						Boats	None	None	Yes
350	118	Right Bank	Flat	Low	Silt/Sand	Heavy	Flat/Beach	Silt/Sand	None-Very Sparse		None	Stable	None/Little	Boats	None	None	Yes
351	1023	Right Bank	Flat	Low	Silt/Sand	Heavy	Moderate	Boulders	None-Very Sparse		None	Stable	None/Little	Boats	None	None	Yes
352	462	Right Bank	Flat	Low	Silt/Sand	Heavy	Flat/Beach	Gravel	None-Very Sparse		None	Stable	None/Little	Boats	None	None	No
353	647	Right Bank	Flat	Low	Silt/Sand	Heavy	Flat/Beach	Cobbles	None-Very Sparse		None	Stable	None/Little	Boats	None	None	Yes
354	296	Right Bank	Flat	Low	Silt/Sand	Heavy	Flat/Beach	Gravel	None-Very Sparse		None	Stable	None/Little	Boats	None	None	Yes
355	557	Right Bank	Flat	Medium	Silt/Sand	Heavy	Flat/Beach	Silt/Sand	Heavy		None	Stable	None/Little	Boats	None	None	Yes
356	283	Right Bank	Flat	High	Silt/Sand	Heavy	Flat/Beach	Cobbles	None-Very Sparse		None	Stable	None/Little	Boats	None	None	No
357	400	Right Bank	Flat	Low	Silt/Sand	Heavy	Flat/Beach	Silt/Sand	Heavy		None	Stable	None/Little	Boats	None	None	Yes

ID	LENGTH (ft)	BANK	UPPER RIVERBANK				LOWER RIVERBANK			EROSION CHARACTERISTICS							
			SLOPE	HEIGHT	SEDIMENT	VEGETATION	SLOPE	SEDIMENT	VEGETATION	TYPE OF EROSION	POTENTIAL INDICATOR OF EROSION	STAGE OF EROSION	EXTENT OF EROSION	DOMINANT CAUSE	CONTRIBUTING CAUSE	CONTRIBUTING CAUSE 2	LAND-USE POTENTIAL CONTRIBUTING CAUSE
358	587	Right Bank	Moderate	High	Silt/Sand	Heavy	Moderate	Bedrock	None-Very Sparse	Undercut	None	Stable	None/Little	Boats	None	None	Yes
359	628	Right Bank	Flat	Low	Silt/Sand	Moderate	Moderate	Bedrock	None-Very Sparse		None	Stable	None/Little	Boats	None	None	No
360	1399	Right Bank	Steep	High	Bedrock	Moderate	Steep	Bedrock	None-Very Sparse		None	Stable	None/Little	Boats	None	None	No
361	701	Right Bank	Moderate	High	Silt/Sand	Heavy	Moderate	Bedrock	None-Very Sparse	Undercut	None	Stable	None/Little	Boats	None	None	No
362	654	Right Bank	Moderate	High	Silt/Sand	Heavy	Flat/Beach	Cobbles	None-Very Sparse	Undercut	None	Stable	None/Little	Boats	None	None	No
363	519	Right Bank	Moderate	High	Silt/Sand	Heavy	Moderate	Bedrock	None-Very Sparse	Undercut	None	Stable	None/Little	Boats	None	None	No
364	741	Right Bank	Moderate	High	Silt/Sand	Heavy	Moderate	Bedrock	None-Very Sparse		None	Stable	None/Little	Boats	None	None	No
365	108	Right Bank	Moderate	High	Silt/Sand	Heavy	Flat/Beach	Silt/Sand	None-Very Sparse		None	Stable	None/Little	Boats	None	None	No
366	424	Right Bank	Flat	Low	Silt/Sand	Heavy	Flat/Beach	Silt/Sand	Heavy		None	Stable	None/Little	Boats	None	None	No
367	214	Right Bank	Flat	Low	Silt/Sand	Heavy	Flat/Beach	Silt/Sand	None-Very Sparse		None	Stable	None/Little	Boats	None	None	No
368	592	Right Bank	Moderate	High	Silt/Sand	Heavy	Flat/Beach	Silt/Sand	None-Very Sparse	Undercut	None	Stable	None/Little	Boats	None	None	No
369	227	Right Bank	Moderate	High	Silt/Sand	Heavy	Moderate	Bedrock	None-Very Sparse	Undercut	Creep/Leaning Trees	Stable	None/Little	Boats	None	None	No
370	223	Right Bank	Steep	High	Bedrock	Moderate	Steep	Bedrock	None-Very Sparse		None	Stable	None/Little	Boats	None	None	No
371	37	Right Bank	Overhanging	High	Silt/Sand	Sparse	Steep	Bedrock	None-Very Sparse	Slide	Overhanging Bank	Eroded	Some	Boats	None	None	No
372	152	Right Bank	Moderate	High	Silt/Sand	Heavy	Moderate	Bedrock	None-Very Sparse		None	Stable	None/Little	Boats	None	None	No
373	308	Right Bank	Moderate	High	Silt/Sand	Heavy	Flat/Beach	Cobbles	None-Very Sparse	Undercut	Creep/Leaning Trees	Stable	None/Little	Boats	None	None	No
374	750	Right Bank	Moderate	High	Silt/Sand	Heavy	Flat/Beach	Silt/Sand	None-Very Sparse		Creep/Leaning Trees	Stable	None/Little	Boats	None	None	No
375	75	Right Bank	Moderate	High	Silt/Sand	Heavy	Flat/Beach	Cobbles	None-Very Sparse	Undercut	Creep/Leaning Trees	Stable	None/Little	Boats	None	None	No
376	589	Right Bank	Moderate	High	Silt/Sand	Heavy	Flat/Beach	Silt/Sand	None-Very Sparse	Undercut	Creep/Leaning Trees	Stable	None/Little	Boats	None	None	No
377	1775	Right Bank	Moderate	High	Silt/Sand	Heavy	Flat/Beach	Silt/Sand	None-Very Sparse	Undercut	None	Stable	None/Little	Boats	None	None	No
378	1394	Right Bank	Moderate	High	Silt/Sand	Heavy	Flat/Beach	Silt/Sand	Heavy		None	Stable	None/Little	Boats	None	None	No
379	248	Right Bank	Moderate	High	Silt/Sand	Heavy	Flat/Beach	Gravel	None-Very Sparse		None	Stable	None/Little	High Flows	Boats	None	No
380	413	Right Bank	Moderate	High	Silt/Sand	Heavy	Flat/Beach	Silt/Sand	Heavy		None	Stable	None/Little	High Flows	Boats	None	No
381	342	Right Bank	Moderate	High	Silt/Sand	Heavy	Flat/Beach	Gravel	None-Very Sparse	Undercut	None	Stable	None/Little	High Flows	Boats	None	No
382	144	Right Bank	Moderate	High	Silt/Sand	Heavy	Flat/Beach	Silt/Sand	Sparse	Undercut	None	Stable	None/Little	High Flows	Boats	None	No
383	393	Right Bank	Moderate	High	Silt/Sand	Heavy	Moderate	Boulders	None-Very Sparse	Undercut	None	Stable	None/Little	High Flows	Boats	None	No

ID	LENGTH (ft)	BANK	UPPER RIVERBANK				LOWER RIVERBANK			EROSION CHARACTERISTICS							
			SLOPE	HEIGHT	SEDIMENT	VEGETATION	SLOPE	SEDIMENT	VEGETATION	TYPE OF EROSION	POTENTIAL INDICATOR OF EROSION	STAGE OF EROSION	EXTENT OF EROSION	DOMINANT CAUSE	CONTRIBUTING CAUSE	CONTRIBUTING CAUSE 2	LAND-USE POTENTIAL CONTRIBUTING CAUSE
384	134	Right Bank	Moderate	High	Silt/Sand	Heavy	Moderate	Bedrock	None-Very Sparse	Undercut	None	Stable	None/Little	High Flows	Boats	None	No
385	102	Right Bank	Moderate	High	Silt/Sand	Heavy	Moderate	Bedrock	None-Very Sparse		None	Stable	None/Little	High Flows	Boats	None	No
386	603	Right Bank	Moderate	High	Silt/Sand	Heavy	Moderate	Boulders	None-Very Sparse	Undercut	None	Stable	None/Little	High Flows	Boats	None	No
387	88	Right Bank	Steep	High	Silt/Sand	Moderate	Moderate	Boulders	None-Very Sparse	Slide	Overhanging Bank	Eroded	Some	High Flows	Boats	None	No
388	405	Right Bank	Moderate	High	Silt/Sand	Heavy	Moderate	Boulders	None-Very Sparse	Undercut	None	Potential Future Erosion	Some	High Flows	Boats	None	No
389	675	Right Bank	Moderate	High	Silt/Sand	Heavy	Moderate	Bedrock	None-Very Sparse		None	Stable	None/Little	High Flows	Boats	None	No
390	302	Right Bank	Moderate	High	Silt/Sand	Heavy	Moderate	Bedrock	None-Very Sparse	Undercut	None	Stable	None/Little	High Flows	Boats	None	No
391	1035	Right Bank	Moderate	High	Silt/Sand	Heavy	Flat/Beach	Silt/Sand	Heavy		None	Stable	None/Little	High Flows	Boats	None	Yes
392	197	Right Bank	Moderate	High	Silt/Sand	Heavy	Moderate	Bedrock	None-Very Sparse		None	Stable	None/Little	High Flows	Boats	None	No
393	212	Right Bank	Flat	High	Silt/Sand	Heavy	Flat/Beach	Silt/Sand	Moderate		None	Stable	None/Little	High Flows	Boats	None	No
394	268	Right Bank	Flat	High	Silt/Sand	Heavy	Flat/Beach	Bedrock	None-Very Sparse		None	Stable	None/Little	High Flows	Boats	None	No
395	1158	Right Bank	Moderate	High	Silt/Sand	Moderate	Moderate	Bedrock	None-Very Sparse		None	Stable	None/Little	High Flows	Boats	None	No
1	1115	Left Bank	Moderate	Low	Silt/Sand	Heavy	Moderate	Boulders	None-Very Sparse		None	Stable	None/Little	Boats	None	None	Yes
2	135	Left Bank	Flat	Low	Silt/Sand	Heavy	Flat/Beach	Silt/Sand	None-Very Sparse	Undercut	None	Stable	None/Little	Boats	None	None	No
3	324	Left Bank	Moderate	High	Silt/Sand	Heavy	Moderate	Boulders	None-Very Sparse		None	Stable	None/Little	Boats	None	None	No
4	451	Left Bank	Moderate	High	Silt/Sand	Heavy	Flat/Beach	Silt/Sand	None-Very Sparse	Undercut	None	Stable	None/Little	Boats	None	None	No
5	1476	Left Bank	Moderate	High	Silt/Sand	Heavy	Moderate	Boulders	None-Very Sparse		None	Stable	None/Little	Boats	None	None	No
6	110	Left Bank	Moderate	High	Silt/Sand	Heavy	Flat/Beach	Silt/Sand	None-Very Sparse		None	Stable	None/Little	Boats	None	None	No
7	249	Left Bank	Moderate	High	Silt/Sand	Heavy	Moderate	Bedrock	None-Very Sparse		None	Stable	None/Little	Boats	None	None	No
8	1088	Left Bank	Moderate	High	Silt/Sand	Moderate	Flat/Beach	Silt/Sand	None-Very Sparse		None	Stable	None/Little	Boats	None	None	No
9	116	Left Bank	Moderate	High	Silt/Sand	Heavy	Flat/Beach	Silt/Sand	Sparse		None	Stable	None/Little	Boats	None	None	No
10	433	Left Bank	Flat	Low	Silt/Sand	Heavy	Flat/Beach	Silt/Sand	None-Very Sparse		None	Stable	None/Little	Boats	None	None	No
11	615	Left Bank	Moderate	High	Silt/Sand	Heavy	Flat/Beach	Silt/Sand	None-Very Sparse		None	Stable	None/Little	Boats	None	None	No
12	190	Left Bank	Steep	High	Silt/Sand	Sparse	Flat/Beach	Silt/Sand	None-Very Sparse	Slide	Other	Active Erosion	Extensive	Boats	None	None	No
13	82	Left Bank	Moderate	High	Silt/Sand	Moderate	Steep	Bedrock	None-Very Sparse	Slide	Other	Active Erosion	Extensive	Boats	None	None	No

ID	LENGTH (ft)	BANK	UPPER RIVERBANK				LOWER RIVERBANK			EROSION CHARACTERISTICS							
			SLOPE	HEIGHT	SEDIMENT	VEGETATION	SLOPE	SEDIMENT	VEGETATION	TYPE OF EROSION	POTENTIAL INDICATOR OF EROSION	STAGE OF EROSION	EXTENT OF EROSION	DOMINANT CAUSE	CONTRIBUTING CAUSE	CONTRIBUTING CAUSE 2	LAND-USE POTENTIAL CONTRIBUTING CAUSE
14	145	Left Bank	Steep	High	Silt/Sand	Sparse	Flat/Beach	Silt/Sand	None-Very Sparse	Slide	Other	Eroded	Some	Boats	None	None	No
15	260	Left Bank	Moderate	High	Silt/Sand	Heavy	Flat/Beach	Silt/Sand	None-Very Sparse		None	Stable	None/Little	Boats	None	None	No
16	850	Left Bank	Flat	Low	Silt/Sand	Heavy	Flat/Beach	Silt/Sand	Moderate		None	Stable	None/Little	Boats	None	None	Yes
17	397	Left Bank	Flat	Low	Silt/Sand	Heavy	Flat/Beach	Silt/Sand	None-Very Sparse		None	Stable	None/Little	Boats	None	None	Yes
18	1560	Left Bank	Moderate	High	Silt/Sand	Heavy	Flat/Beach	Silt/Sand	None-Very Sparse		Creep/Leaning Trees	Stable	None/Little	Boats	None	None	No
19	117	Left Bank	Moderate	Medium	Silt/Sand	Heavy	Vertical	Bedrock	None-Very Sparse	Slide	Other	Eroded	Some	Boats	None	None	Yes
20	179	Left Bank	Moderate	Low	Silt/Sand	Heavy	Flat/Beach	Silt/Sand	None-Very Sparse	Undercut	None	Stable	None/Little	Boats	None	None	No
21	1299	Left Bank	Moderate	High	Silt/Sand	Heavy	Flat/Beach	Silt/Sand	None-Very Sparse	Undercut	Creep/Leaning Trees	Stable	None/Little	Boats	None	None	No
22	532	Left Bank	Flat	Low	Silt/Sand	Heavy	Flat/Beach	Silt/Sand	Sparse		None	Stable	None/Little	Boats	None	None	No
23	384	Left Bank	Moderate	High	Silt/Sand	Heavy	Flat/Beach	Silt/Sand	None-Very Sparse		None	Stable	None/Little	Boats	None	None	No
24	548	Left Bank	Moderate	High	Silt/Sand	Heavy	Flat/Beach	Silt/Sand	None-Very Sparse	Undercut	Creep/Leaning Trees	Stable	None/Little	Boats	None	None	No
25	94	Left Bank	Moderate	High	Silt/Sand	Moderate	Moderate	Boulders	None-Very Sparse		None	Stable	None/Little	Boats	None	None	Yes
26	256	Left Bank	Moderate	High	Silt/Sand	Heavy	Flat/Beach	Silt/Sand	None-Very Sparse	Undercut	None	Stable	None/Little	High Flows	Boats	None	Yes
27	271	Left Bank	Moderate	High	Silt/Sand	Heavy	Moderate	Bedrock	None-Very Sparse	Undercut	None	Stable	None/Little	High Flows	Boats	None	Yes
28	52	Left Bank	Moderate	High	Silt/Sand	Heavy	Flat/Beach	Gravel	None-Very Sparse		None	Stable	None/Little	High Flows	Boats	None	No
29	101	Left Bank	Flat	Low	Silt/Sand	Heavy	Flat/Beach	Boulders	None-Very Sparse		None	Stable	None/Little	High Flows	Boats	None	No
30	347	Left Bank	Moderate	High	Silt/Sand	Heavy	Flat/Beach	Silt/Sand	None-Very Sparse	Undercut	Creep/Leaning Trees	Stable	None/Little	High Flows	Boats	None	No
31	95	Left Bank	Flat	Low	Silt/Sand	Heavy	Flat/Beach	Cobbles	None-Very Sparse		None	Stable	None/Little	High Flows	Boats	None	Yes
32	102	Left Bank	Moderate	High	Silt/Sand	Heavy	Flat/Beach	Silt/Sand	None-Very Sparse	Undercut	None	Stable	None/Little	High Flows	Boats	None	Yes
33	164	Left Bank	Moderate	High	Silt/Sand	Heavy	Moderate	Boulders	None-Very Sparse	Undercut	Creep/Leaning Trees	Stable	None/Little	High Flows	Boats	None	Yes
34	319	Left Bank	Moderate	High	Silt/Sand	Heavy	Moderate	Bedrock	None-Very Sparse		None	Stable	None/Little	High Flows	Boats	None	Yes
35	79	Left Bank	Flat	Low	Silt/Sand	Heavy	Moderate	Boulders	None-Very Sparse	Undercut	None	Stable	None/Little	High Flows	Boats	None	Yes
36	309	Left Bank	Moderate	High	Silt/Sand	Heavy	Flat/Beach	Boulders	None-Very Sparse		None	Stable	None/Little	High Flows	Boats	None	No
37	319	Left Bank	Moderate	High	Silt/Sand	Heavy	Flat/Beach	Silt/Sand	None-Very Sparse		None	Stable	None/Little	High Flows	Boats	None	No
38	812	Left Bank	Moderate	High	Silt/Sand	Heavy	Flat/Beach	Silt/Sand	None-Very Sparse	Undercut	Creep/Leaning Trees	Stable	None/Little	High Flows	Boats	None	No

ID	LENGTH (ft)	BANK	UPPER RIVERBANK				LOWER RIVERBANK			EROSION CHARACTERISTICS							
			SLOPE	HEIGHT	SEDIMENT	VEGETATION	SLOPE	SEDIMENT	VEGETATION	TYPE OF EROSION	POTENTIAL INDICATOR OF EROSION	STAGE OF EROSION	EXTENT OF EROSION	DOMINANT CAUSE	CONTRIBUTING CAUSE	CONTRIBUTING CAUSE 2	LAND-USE POTENTIAL CONTRIBUTING CAUSE
39	48	Left Bank	Moderate	High	Silt/Sand	Heavy	Flat/Beach	Bedrock	None-Very Sparse	Undercut	None	Stable	None/Little	High Flows	Boats	None	No
40	359	Left Bank	Moderate	High	Silt/Sand	Heavy	Flat/Beach	Silt/Sand	None-Very Sparse	Undercut	None	Stable	None/Little	High Flows	Boats	None	No
41	146	Left Bank	Moderate	High	Silt/Sand	Heavy	Moderate	Bedrock	None-Very Sparse	Undercut	None	Stable	None/Little	High Flows	Boats	None	No
42	90	Left Bank	Moderate	High	Silt/Sand	Heavy	Flat/Beach	Gravel	None-Very Sparse		None	Stable	None/Little	High Flows	Boats	None	No
43	225	Left Bank	Moderate	High	Silt/Sand	Heavy	Flat/Beach	Silt/Sand	None-Very Sparse		None	Stable	None/Little	High Flows	Boats	None	No
44	1308	Left Bank	Moderate	High	Silt/Sand	Heavy	Moderate	Bedrock	None-Very Sparse		None	Stable	None/Little	High Flows	Boats	None	No
45	169	Left Bank	Moderate	High	Silt/Sand	Heavy	Moderate	Boulders	None-Very Sparse		None	Stable	None/Little	High Flows	Boats	None	No
201	45	Left Bank	Overhanging	High	Silt/Sand	Moderate	Flat/Beach	Silt/Sand	None-Very Sparse	Slide	Overhanging Bank	Eroded	Some	High Flows	None	None	Yes
181	20	Left Bank	Overhanging	High	Silt/Sand	Moderate	Flat/Beach	Silt/Sand	None-Very Sparse	Undercut	Overhanging Bank	Eroded	Some	High Flows	None	None	Yes
182	26	Left Bank	Steep	Low	Silt/Sand	Sparse	Flat/Beach	Silt/Sand	None-Very Sparse	Gulley	None	Eroded	Some	High Flows	None	None	Yes